







EROSION CONTROL PLAN LEGEND
 (Installation Details Found in the SMP2 Plan)

-  - DROP INLET PROTECTION
-  - CURB INLET PROTECTION
-  - DITCH CHECKS
-  - SILT FENCING
-  - CUT-OFF TRENCH
-  - BACK OF CURB PROTECTION
-  - EROSION CONTROL MAT

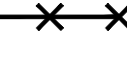
NO SCALE

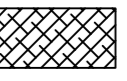

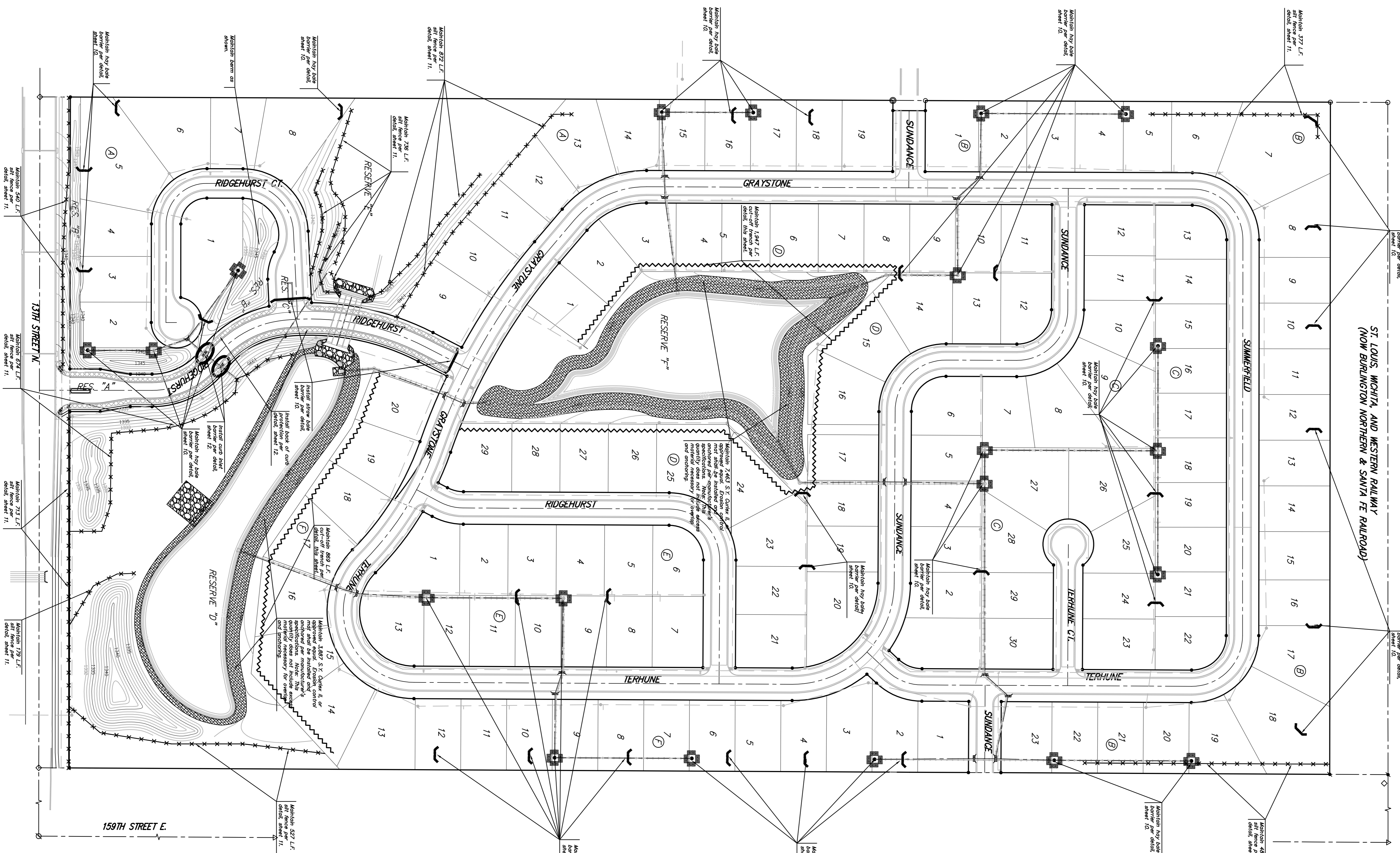
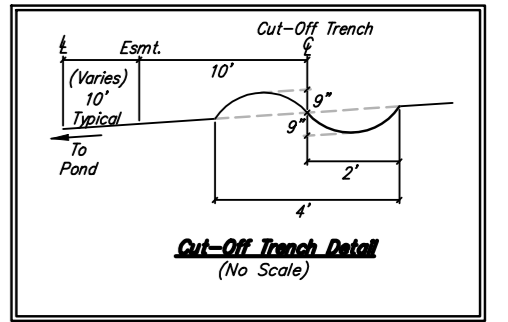
Maintain one construction entrance onto existing paved roadway per detail, sheet 12.

Baughman STONEBRIDGE 2ND ADD.
EROSION CONTROL PLAN
 ENTRANCE STREET PLANS

Baughman Company, P.A. 315 Ellis St. Wichita, KS 67211 F 316-262-7271 F 316-262-0149
 ENGINEERING | SURVEYING | PLANNING | LANDSCAPE ARCHITECTURE

| | |
|-----------------------------|---------------------------|
| PROJECT NUMBER 472-84594 | DESIGN TMS |
| REVISIONS: | APPROVED DATE 01/08 |
| | SCALE Noted |
| | SHEET 8 OF 16 |

/EntrStECplan 0607-E601