

EXPANSION JOINT

NOTE: Extra Thickness to be Subsidiary to Price of Square Yards Pavement

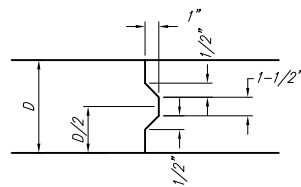

KEYWAY DETAIL

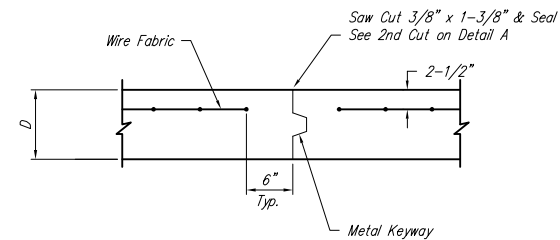

OPTIONAL CONTRACTION JOINT

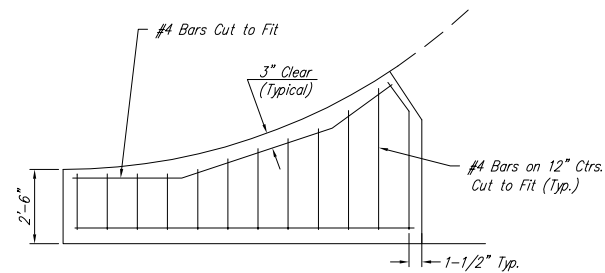

WING REINFORCING DETAIL

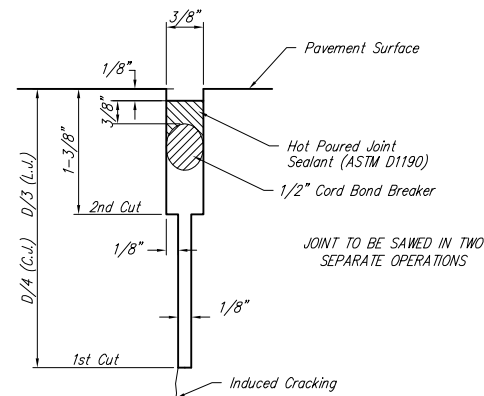

SAW JOINT DETAIL

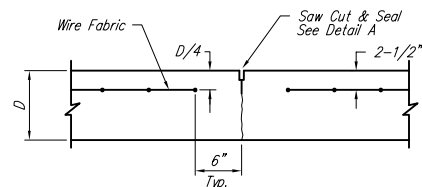

CONTRACTION JOINT DETAIL (C.J.)

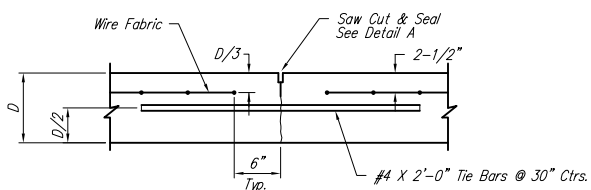

LONGITUDINAL JOINT DETAIL (L.J.)

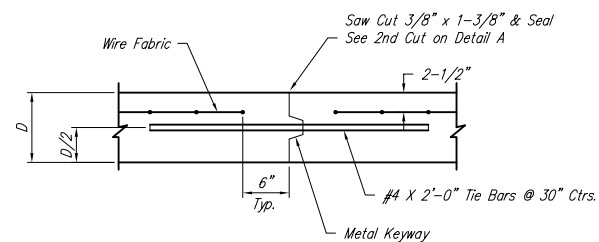

OPTIONAL LONGITUDINAL JOINT DETAIL (L.J.)

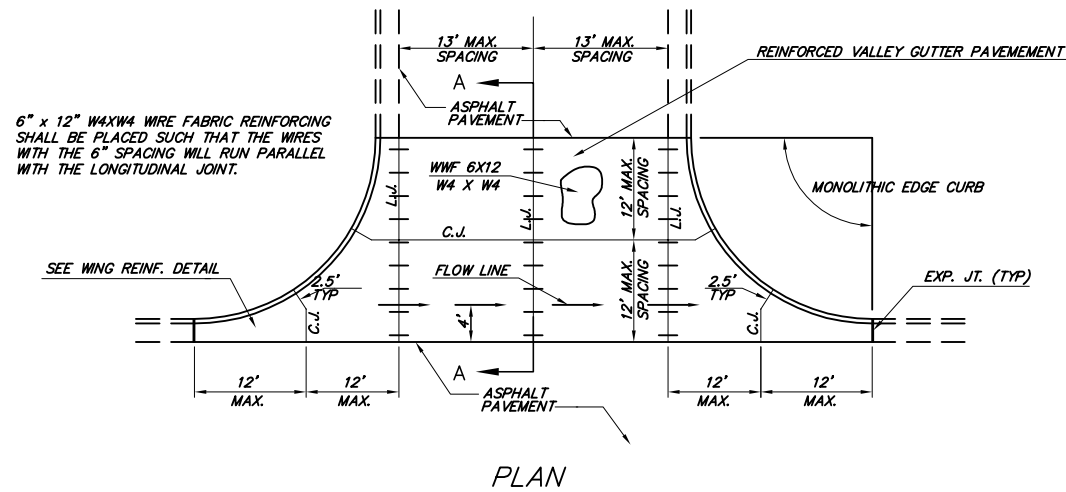

PLAN

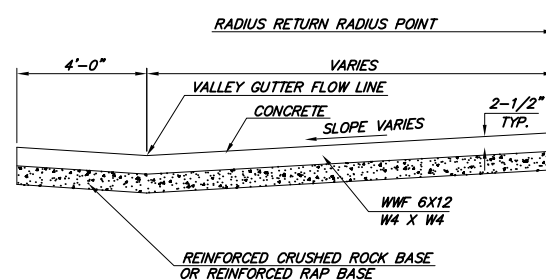

SECTION A-A

REINFORCED VALLEY GUTTER DETAIL

<p>THE CITY OF WICHITA CITY ENGINEER'S OFFICE CITY HALL - SEVENTH FLOOR 455 NORTH MAIN STREET WICHITA, KANSAS 67202 (316) 268-4501 (316) 268-4114 FAX</p>	VALLEY GUTTER DETAILS	
	WHEELCHAIR RAMP DETAILS	
	PROJECT NUMBER 472-84285	OCA # 765965
	DATE MAR 96	SHEET 4 OF 32