

EXPANSION JOINT
NOTE: Extra Thickness to be Subsidiary to Price of Square Yards Pavement

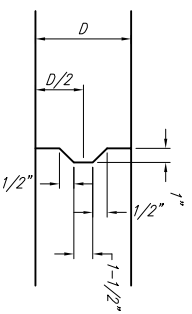

KEYWAY DETAIL

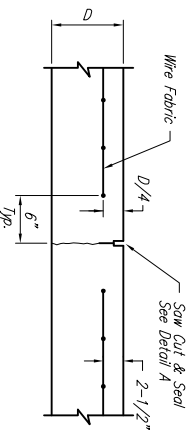

CONTRACTION JOINT DETAIL (C.J.)

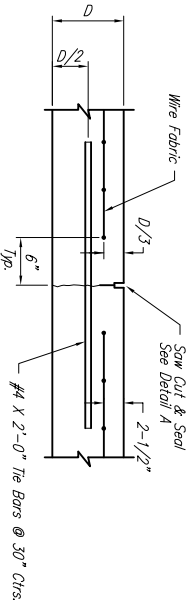

LONGITUDINAL JOINT DETAIL (L.J.)

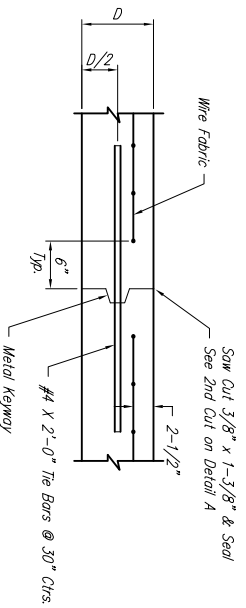

OPTIONAL LONGITUDINAL JOINT DETAIL (L.J.)

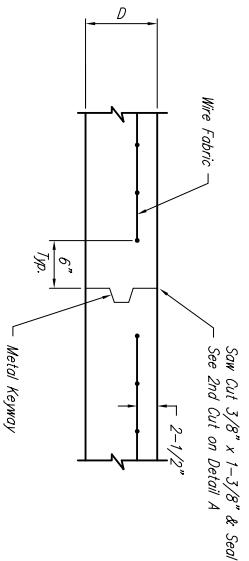

OPTIONAL CONTRACTION JOINT

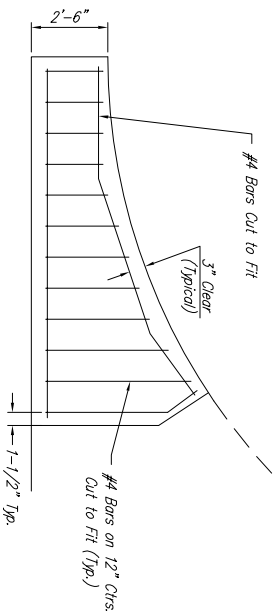

WING REINFORCING DETAIL

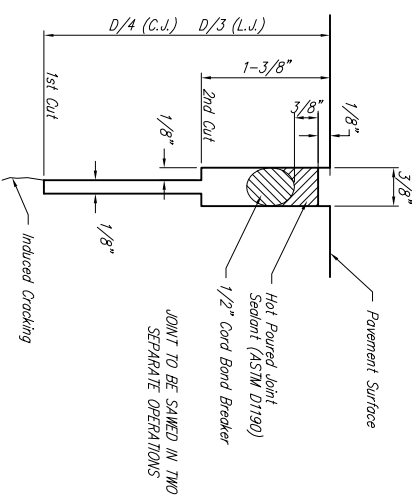

SAW JOINT DETAIL

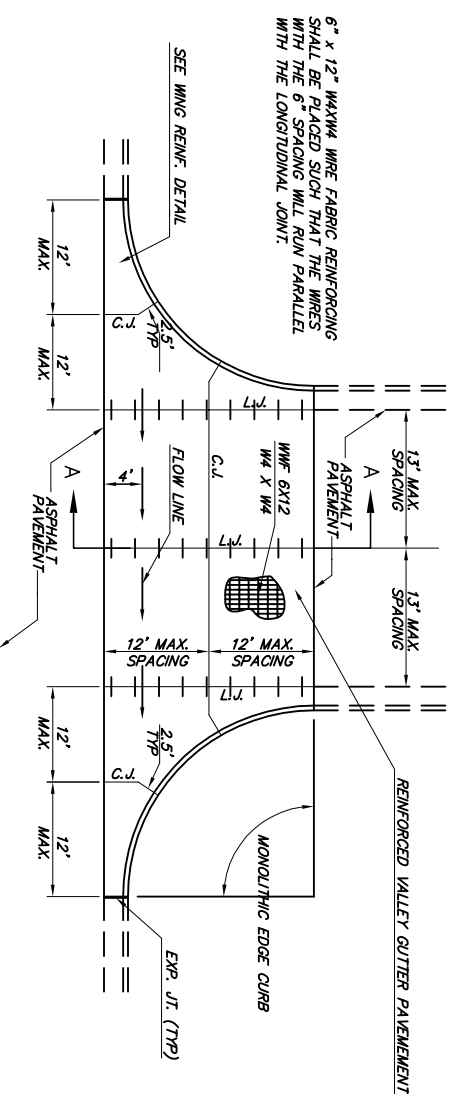

PLAN

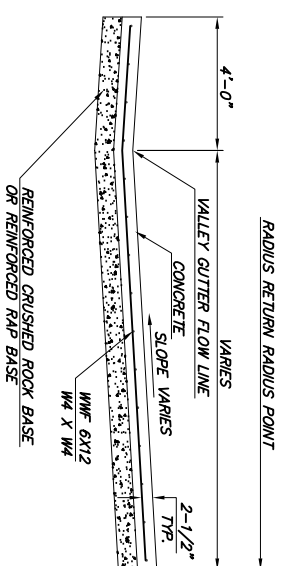

SECTION A-A

REINFORCED VALLEY GUTTER DETAIL

THE CITY OF MICHITA

VALLEY GUTTER DETAILS

CITY ENGINEER'S OFFICE
CITY HALL - SEVENTH FLOOR
MICHITA, ILLINOIS 61702
(313) 252-1114 FAX

PROJECT NUMBER: 4.72-84139
DATE: MAR 96

SHEET 5 OF 4.3