

NOTE: Expansion Joint Only in Curb Area With Concrete Pavment.

PLAN

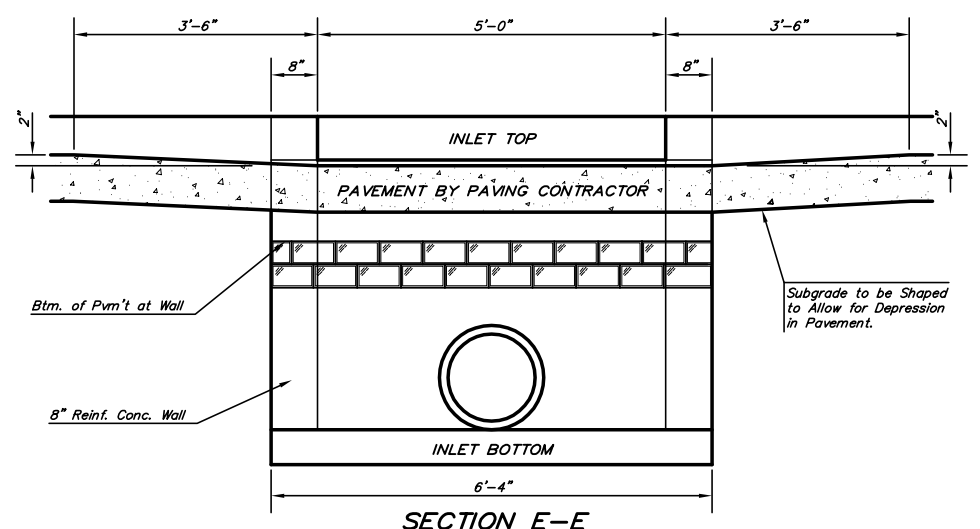

SECTION E-E

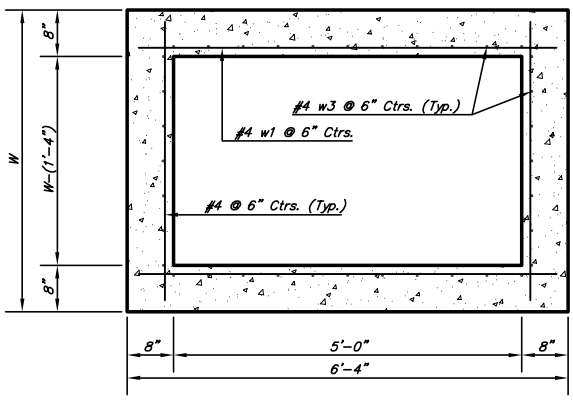

SECTION D-D

NOTE: Contractor shall have the option of constructing 8" brick masonry walls between the concrete inlet base and top on this inlet when W=6'-4" and H=7'-0" or less.

Additional curb and gutter construction necessary to connect set-back inlet to pavement will be paid for at the unit price bid for each inlet hookup.

Inlet invert shall be shaped with 8 sack sand mix concrete to create flow channels and to increase hydraulic efficiency such that the inlet will be self-cleaning between all inlet and/or outlet pipes.

The ends of all pipes installed in inlets shall be cut off flush with the inside face of the inlet wall

NOTE: Inlet Top Reinforcing shall be Spaced on 6" Max. Centers. Inlet Lids Shall be Notched Out as Indicated to Facilitate Construction of Curb.

NOTE: Concrete Tops to be installed on thin mortar cushion to insure full support along brick walls. Concrete tops may be cast in place or precast. Concrete used for inlet construction shall be concrete pavement mix with air entrainment.

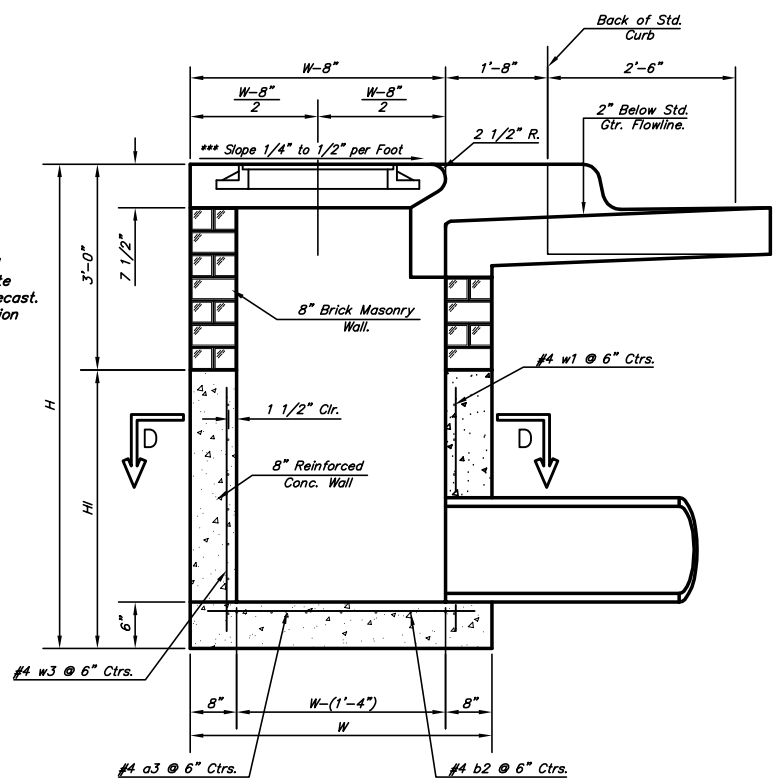

SECTION A-A

***NOTE: Slope of Inlet tops to Match Sidewalk or Parking Slopes within Limits Indicated.

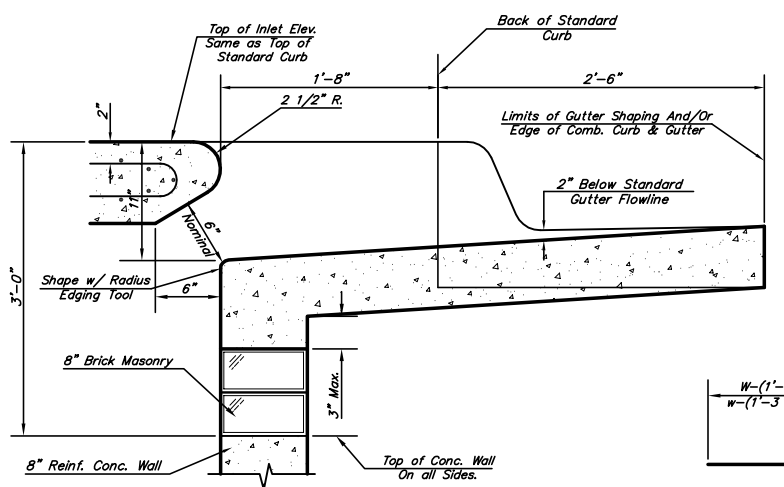

SECTION B-B

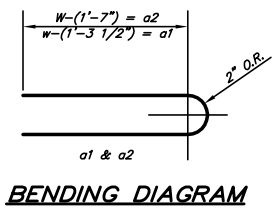

BENDING DIAGRAM

PRECAST SLAB AND FLOOR REINFORCING											
MARK	SIZE	W = 4'-4"		W = 5'-4"		W = 6'-4"		W = 7'-4"		W = 8'-4"	
		NO.	LENGTH	NO.	LENGTH	NO.	LENGTH	NO.	LENGTH	NO.	LENGTH
a1	#4	6	6'-7"	6	8'-7"	6	10'-7"	6	12'-7"	6	14'-7"
a2	#4	4	6'-0"	4	8'-0"	4	10'-0"	4	12'-0"	4	14'-0"
a3	#4	13	4'-1"	13	5'-1"	13	6'-1"	13	7'-1"	13	8'-1"
b1	#4	1	4'-9"	1	4'-9"	1	4'-9"	1	4'-9"	1	4'-9"
b2	#4	23	6'-1"	29	6'-1"	35	6'-1"	41	6'-1"	47	6'-1"
x1	#4	8	3'-10"	8	4'-2"	8	4'-6"	8	4'-10"	8	5'-2"

WALL REINFORCING											
MARK	SIZE	W = 4'-4"		W = 5'-4"		W = 6'-4"		W = 7'-4"		W = 8'-4"	
		NO.	LENGTH	NO.	LENGTH	NO.	LENGTH	NO.	LENGTH	NO.	LENGTH
w1	#4	①	6'-1"	①	6'-1"	①	6'-1"	①	6'-1"	①	6'-1"
w2	#4	①	4'-1"	①	5'-1"	①	6'-1"	①	7'-1"	①	8'-1"
w3	#4	32	②	36	②	40	②	44	②	48	②

* Field Bend or Cut Reinforcing as Required for Clearance.
 ① 4 (H - 12") (H - 21") Rounded down to nearest 0.5'
 ② H - 3"

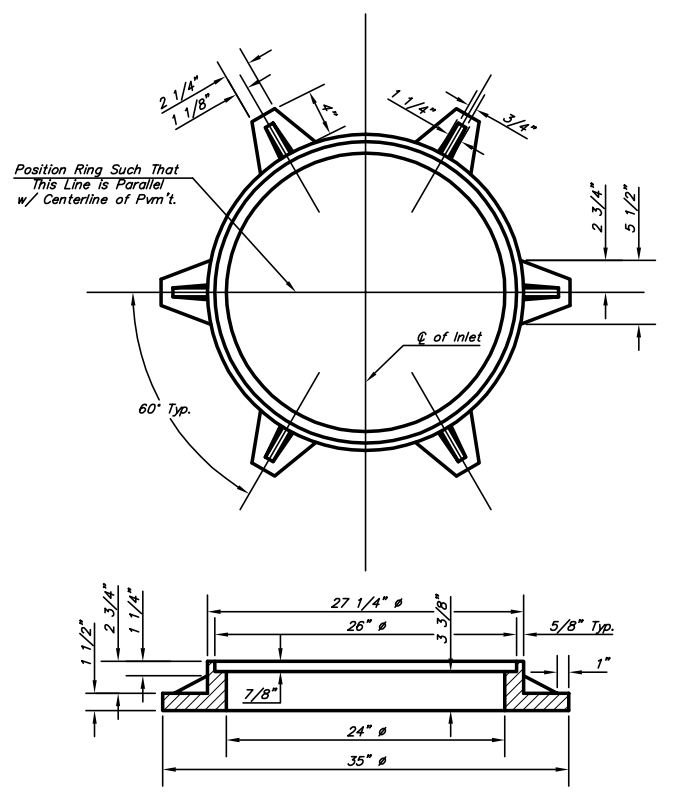

MANHOLE RING AND COVER

Weight = 180 Lbs.
 *See City of Wichita Standard Manhole Ring and Cover Detail Sheet for Cover Details to Be Used With Inlet Frame.

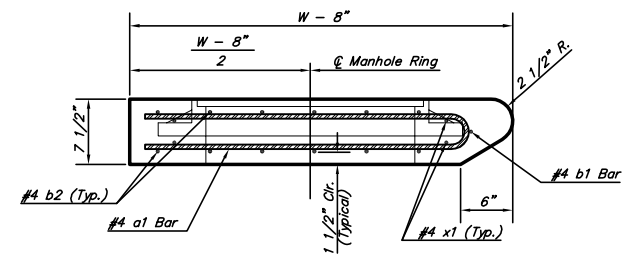

SECTION A-A

STANDARD CURB INLET PRECAST TOPS				
W	PRE-CAST TOP SIZE	PIPE SIZE	CU. YD. CONC.	
4'-4"	3'-8" x 6'-4" x 7 1/2"	21" & SMALLER	0.38±	
5'-4"	4'-8" x 6'-4" x 7 1/2"	24" & 30"	0.51±	
6'-4"	5'-8" x 6'-4" x 7 1/2"	36" & 42"	0.64±	
7'-4"	6'-8" x 6'-4" x 7 1/2"	48" & 54"	0.77±	
8'-4"	7'-8" x 6'-4" x 7 1/2"	60" & 66"	0.90±	

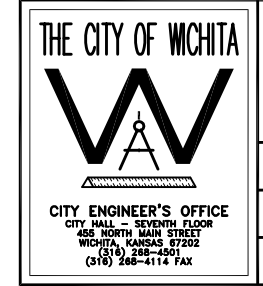

STANDARD TYPE 1-A CURB INLET
OPENING = 6"x5'-0"

M. E. LINDEBAK P.E. - CITY ENGINEER

PROJECT NUMBER	OCA #
472-83703	765791
DATE	SHEET
MAR 96	26 OF 69

CITY ENGINEER'S OFFICE
 455 NORTH MAIN STREET
 WICHITA, KANSAS 67202
 (316) 268-4501
 (316) 268-4114 FAX