

EXPANSION JOINT

NOTE: Extra Thickness to be Subsidiary to Price of Square Yards Pavement

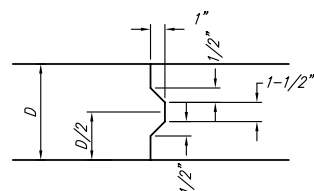

KEYWAY DETAIL

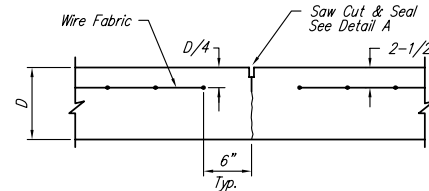

CONTRACTION JOINT DETAIL (C.J.)

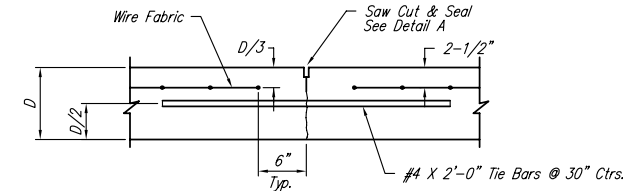

LONGITUDINAL JOINT DETAIL (L.J.)

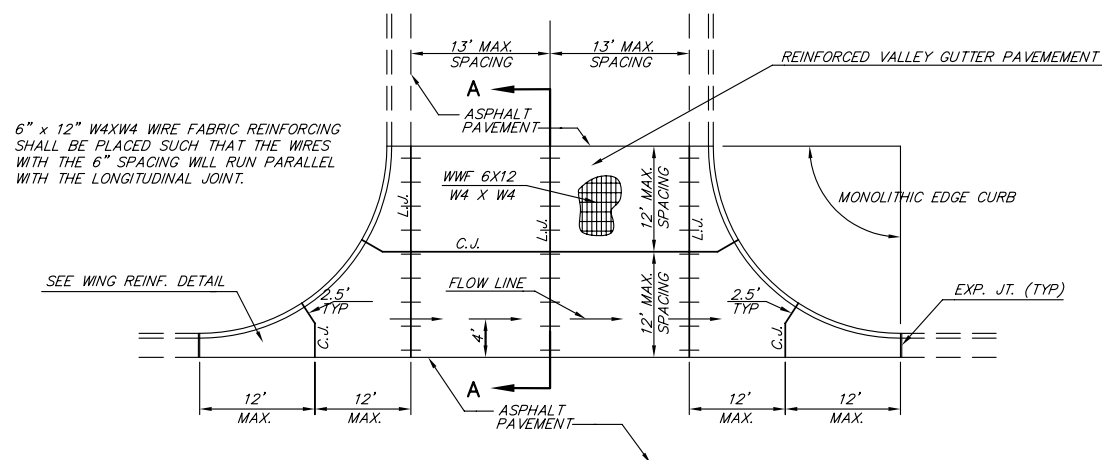

PLAN

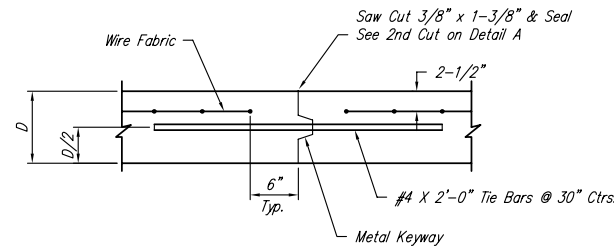

OPTIONAL LONGITUDINAL JOINT DETAIL (L.J.)

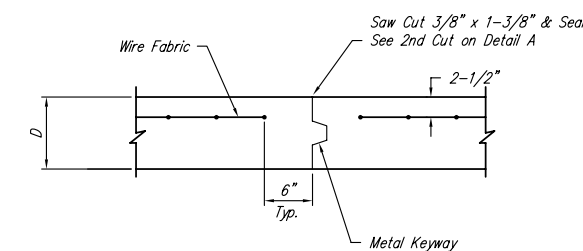

OPTIONAL CONTRACTION JOINT

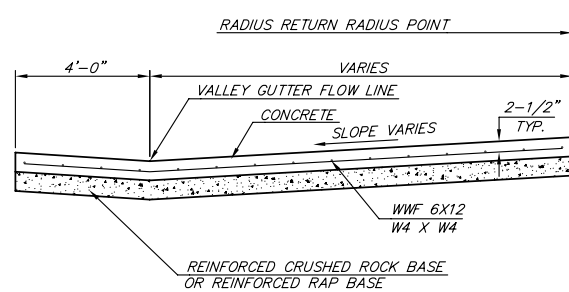

SECTION A-A

REINFORCED VALLEY GUTTER DETAIL

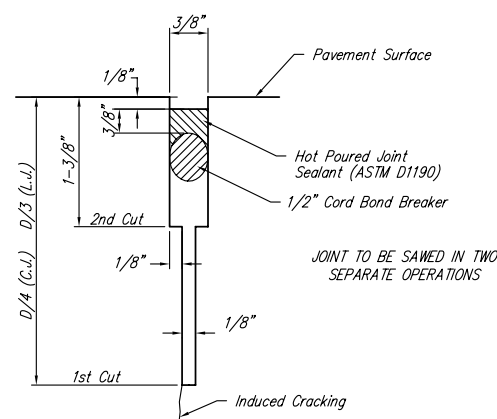

SAW JOINT DETAIL

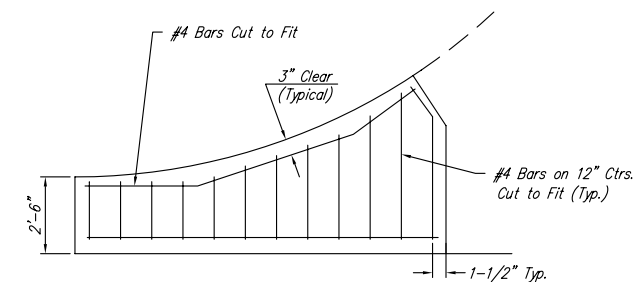

WING REINFORCING DETAIL

<p>THE CITY OF WICHITA</p>	VALLEY GUTTER DETAILS	
	<p>JAMES L. ARMOUR, P.E. - CITY ENGINEER</p>	
<p>CITY ENGINEER'S OFFICE CITY HALL - SEVENTH FLOOR 455 NORTH MAIN STREET WICHITA, KANSAS 67202 (316) 268-4501 (316) 268-4114 FAX</p>	PROJECT NUMBER 472-84421	OCA NUMBER 766100
	DATE SEP 06	Sheet 4 of 31

G:\CIVIL\99118\DWG\PAV\CONN.PH PART 2\99118E02