

Transition to normal curb and gutter section.
Gutter shall be shaped to provide positive drainage.
See Standard Drawing No. RD725 for additional details.

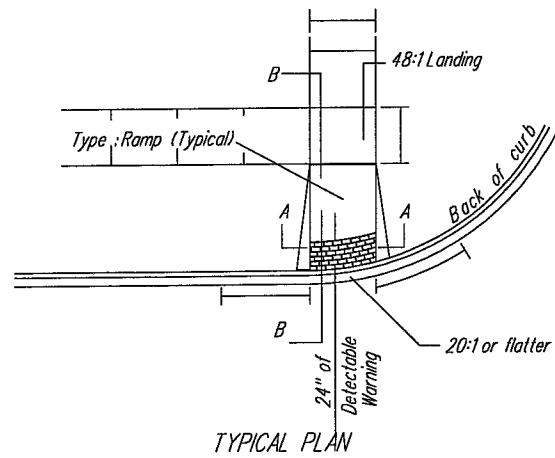

Median ramp crossing limits will be paid for as "Sidewalk Ramp."
These dimensions are nominal.

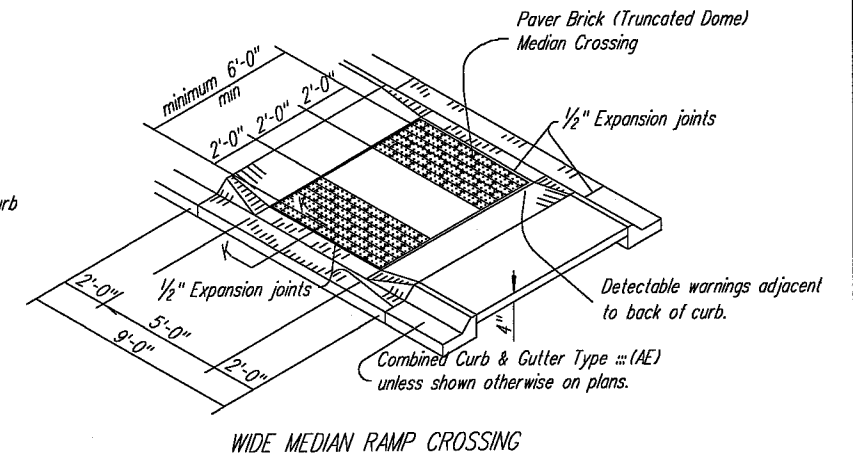
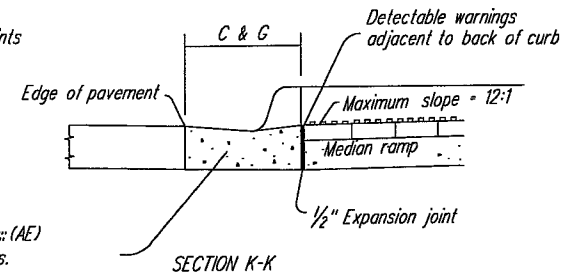
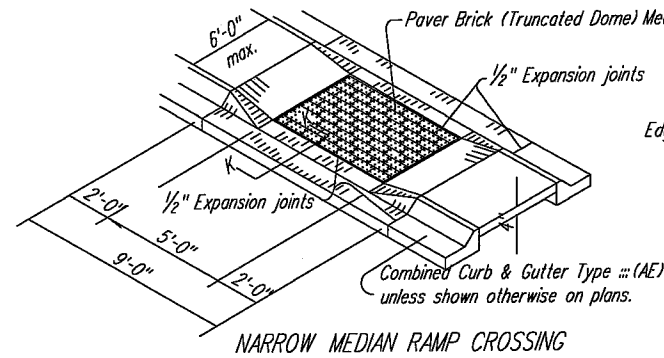

Note: A Median Ramp Crossing shall be constructed at Crosswalk locations.
Wider median islands will result in a 2' minimum gap between the truncated dome areas.

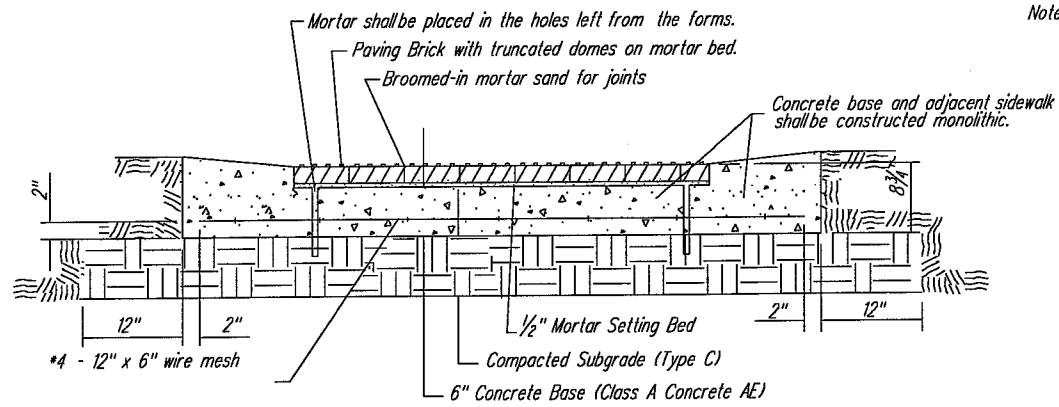

TYPICAL SECTION OF PAVER BRICK
SECTION A-A

Note: A Median Ramp Crossing shall be constructed at Crosswalk locations.

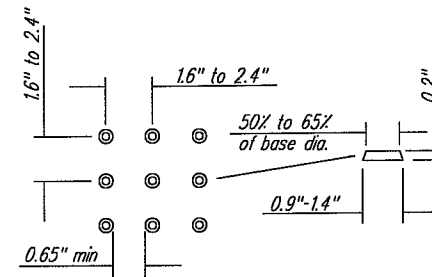
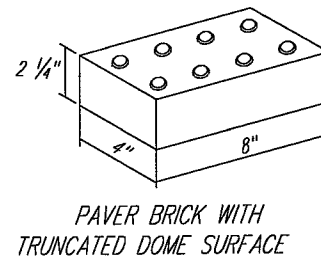

TRUNCATED DOME DIMENSIONS
for SQUARE PATTERN
(Parallel Alignment)

GENERAL NOTES

The details depicted here may not be appropriate for all locations. Designs shall meet this criteria on all new construction projects unless impracticable by site restrictions. For an existing sidewalk facility where the sidewalk will be replaced, this sidewalk will be replaced according to this drawing to the maximum extent feasible. Paving Brick (Truncated Dome Surface) units shall meet the requirements of the standard specifications. The bricks shall be placed in a pattern that conforms to this drawing and aligned in the direction of pedestrian travel. The bricks shall have a truncated dome top surface for detectable warning to pedestrians and comply with the American Disabilities Act. The truncated dome surface shall cover the width of the ramp and extend a length of 24" as shown on this drawing and standard drawing RD725. The truncated dome surface shall be a contrasting color to the adjacent surfaces. The bricks shall be saw cut only and any brick shall not be less than 25% of a full brick. The mortar setting bed and joint mortar sand shall meet the requirements in the standard specifications. The entire ramp or median crossing as shown will be bid as "Sidewalk Ramp" and payment for this work will be measured by the square yard. All materials and labor to install the sidewalk ramp shall be subsidiary to the bid item "Sidewalk Ramp."

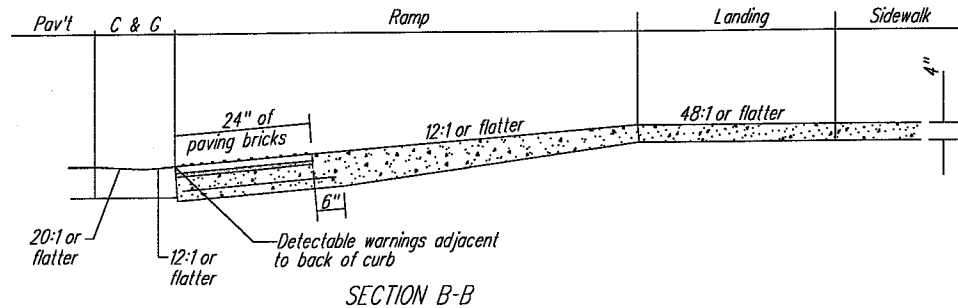

SECTION B-B

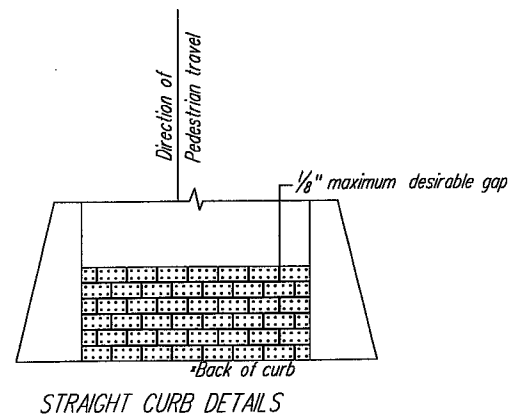

STRAIGHT CURB DETAILS

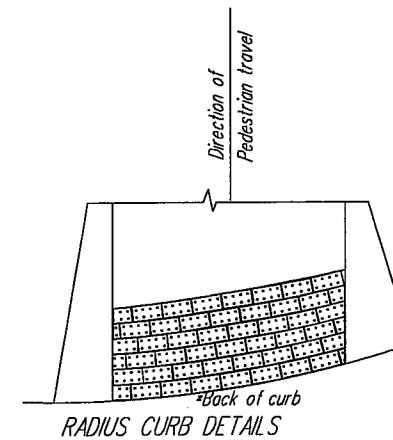

RADIUS CURB DETAILS

The installation pattern shown for the detectable warning paving bricks is running bond. Other patterns may be used upon the approval of the Engineer. The truncated domes on the bricks shall be placed in a parallel alignment for the direction of pedestrian travel as shown. The running bond pattern may be rotated 90° to reduce the spacing between the bricks for radius installations. The spacing between bricks for radius curb installations may vary for each site. This spacing shall be kept to a minimum upon review and approval of the Engineer.

	PAWNEE STREET FROM MERIDIAN TO SENECA ST.		
	CITY ENGINEER JAMES L. ARMOUR, P.E.		
	PROJECT NUMBER 472-84356	DCA NUMBER 706958	DATE 11/03
	CITY ENGINEER'S OFFICE CITY HALL - SEVENTH FLOOR 455 NORTH MAIN STREET WICHITA, KANSAS 67202-1620 (316) 268-4501 (316) 268-4114 FAX		DESIGN JRL
			SHEET 31