

**STORM WATER SEWER  
MONARCH LANDING ADDITION  
PHASE 1**

**LINES 12 - 14**  
SHEET TITLE  
468-84319  
PROJECT NUMBER

DESIGN BY *DFL*  
DRAWN BY *SMS/DMU*  
CHECKED BY *GJA*

ISSUED *February 07*  
REVISED

SHEET NO.  
**18 of 26**

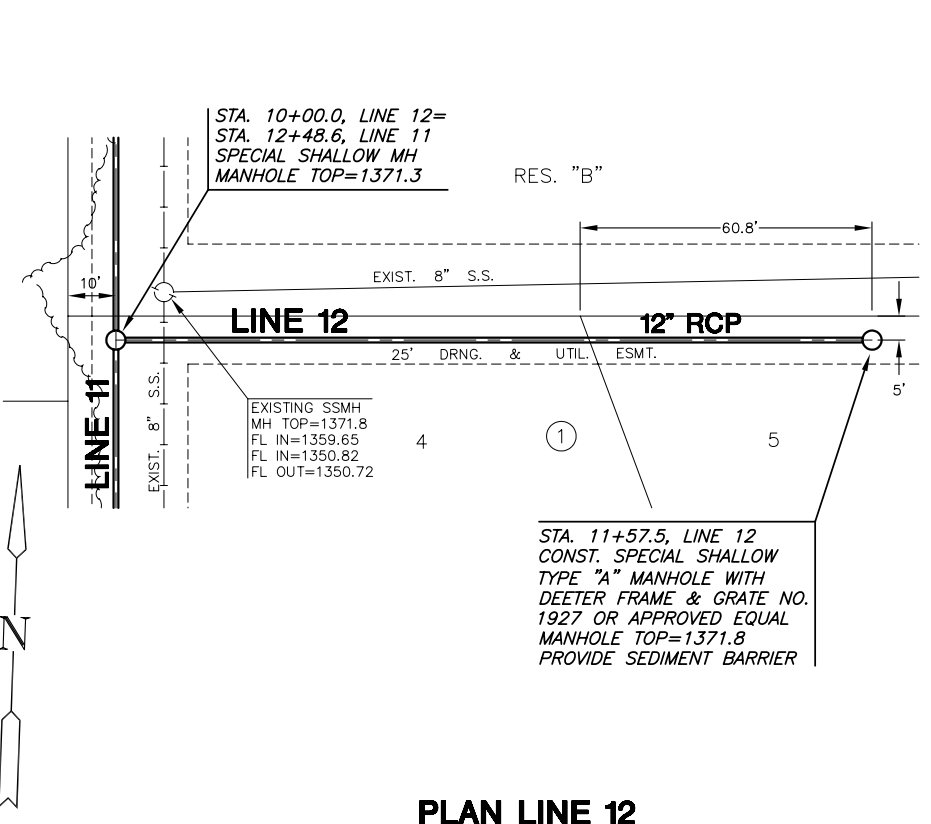

**PLAN LINE 12**

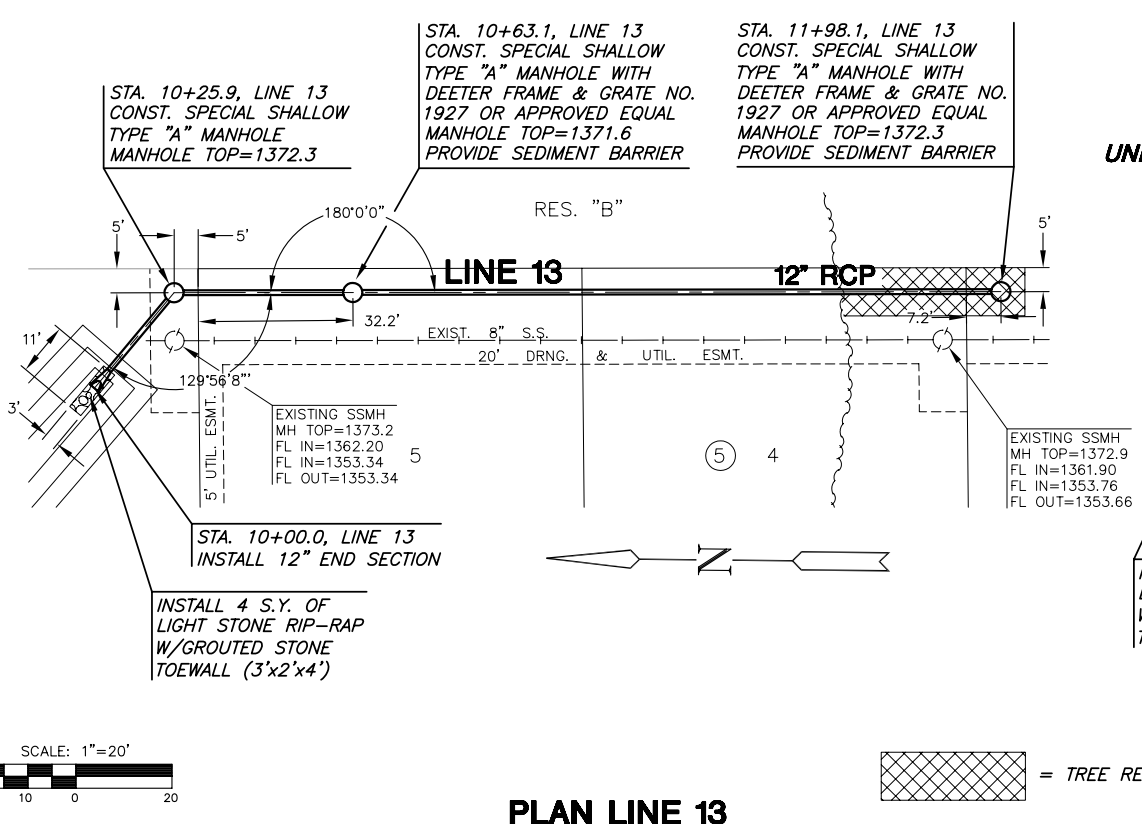

**PLAN LINE 13**

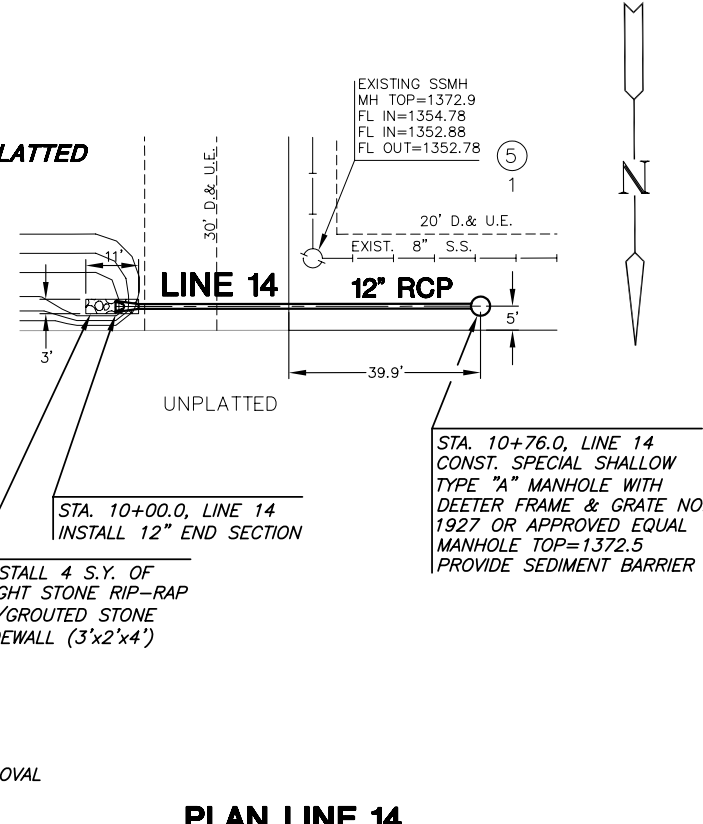

**PLAN LINE 14**

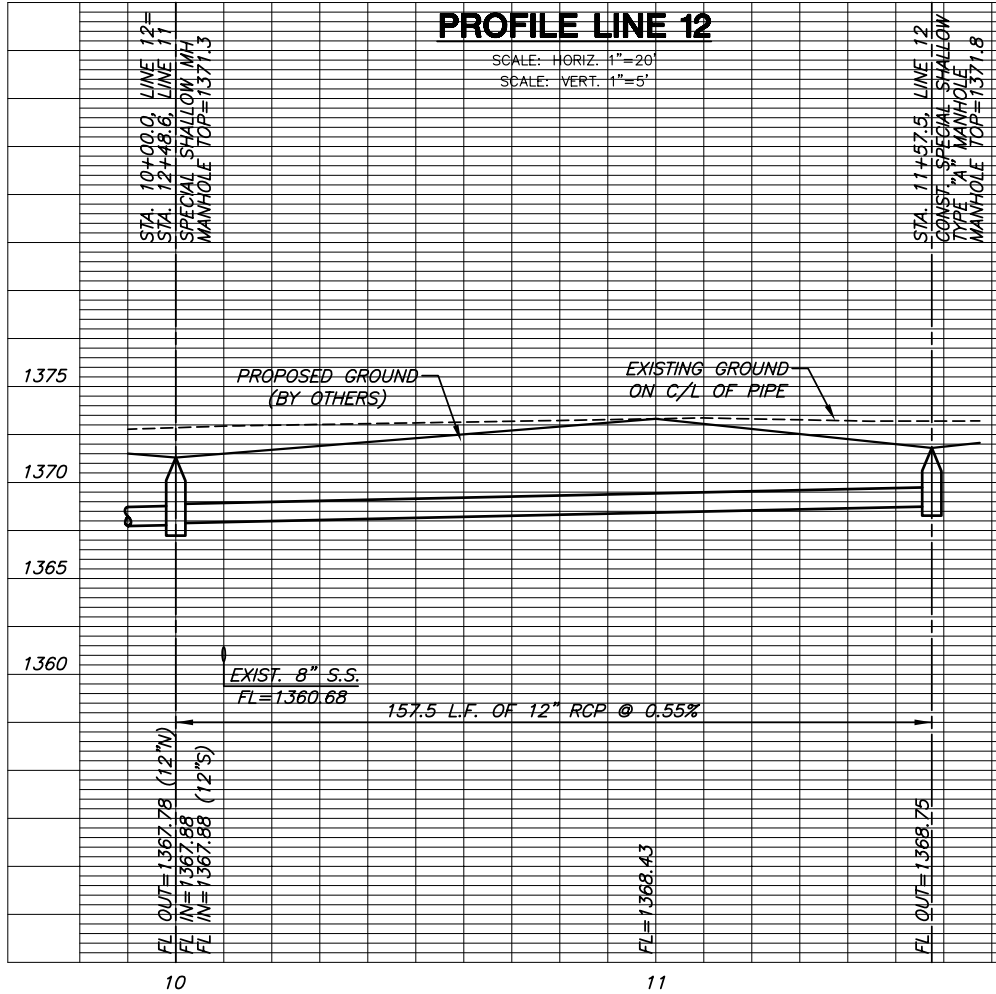
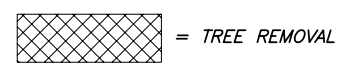
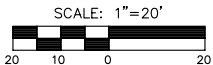

**PROFILE LINE 12**

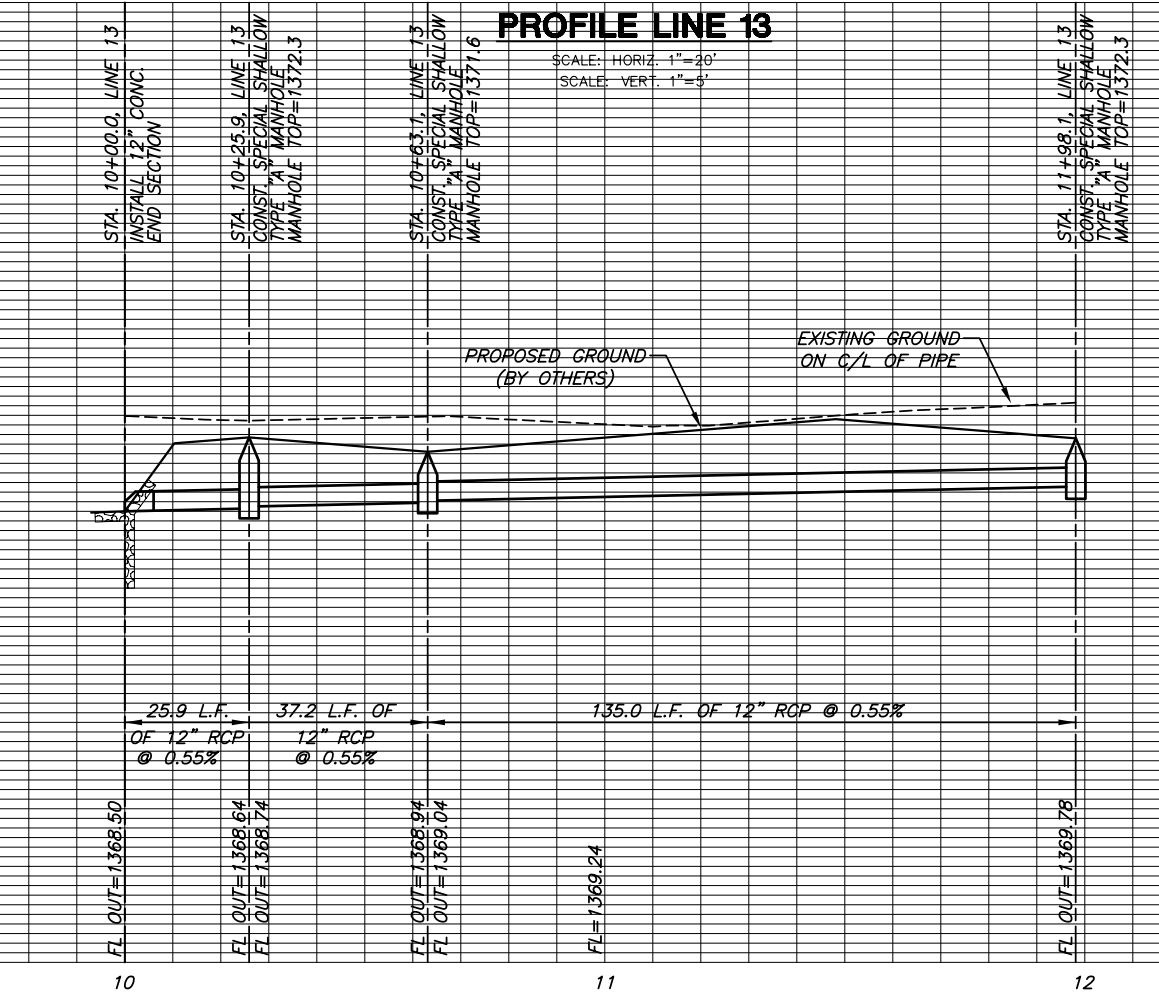

**PROFILE LINE 13**

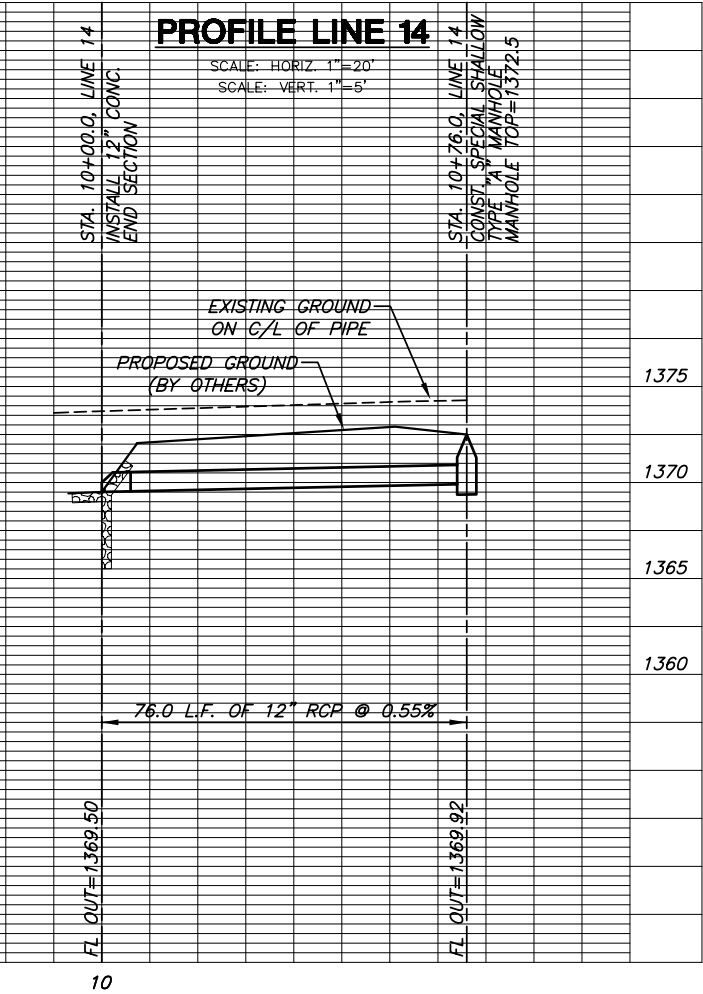

**PROFILE LINE 14**

PLT07B: Wednesday, March 07, 2007 @ 08:25AM

J:\CIVIL\06201\DWG\SW\SPH1\06201\_D13.DWG