

EXPANSION JOINT

NOTE: Extra Thickness to be Subsidiary to Price of Square Yards Pavement

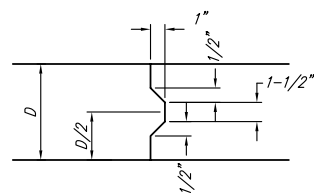

KEYWAY DETAIL

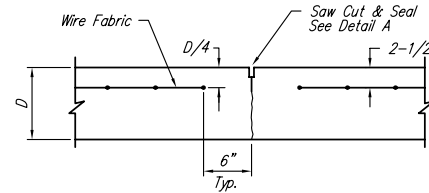

CONTRACTION JOINT DETAIL (C.J.)

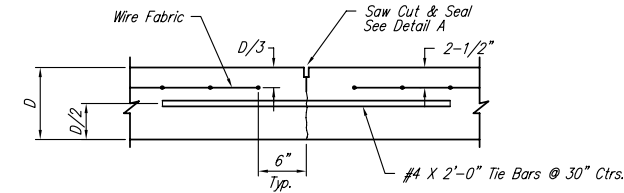

LONGITUDINAL JOINT DETAIL (L.J.)

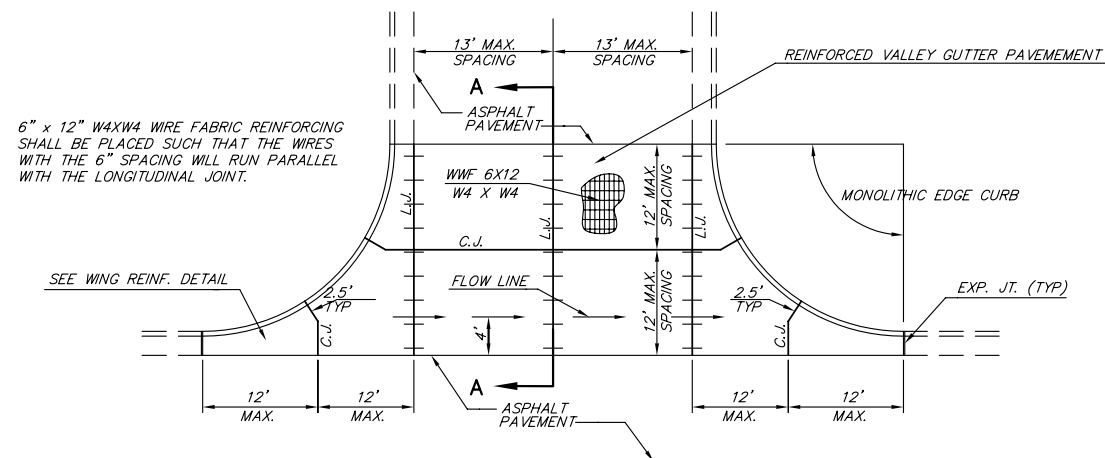

PLAN

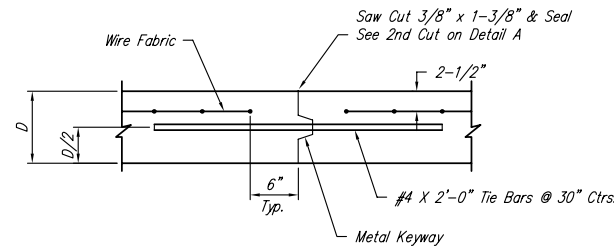

OPTIONAL LONGITUDINAL JOINT DETAIL (L.J.)

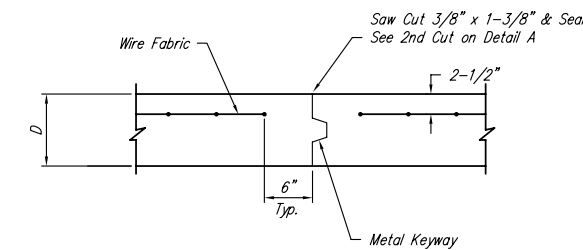

OPTIONAL CONTRACTION JOINT

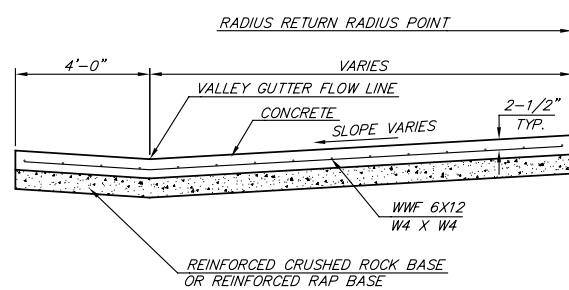

SECTION A-A

REINFORCED VALLEY GUTTER DETAIL

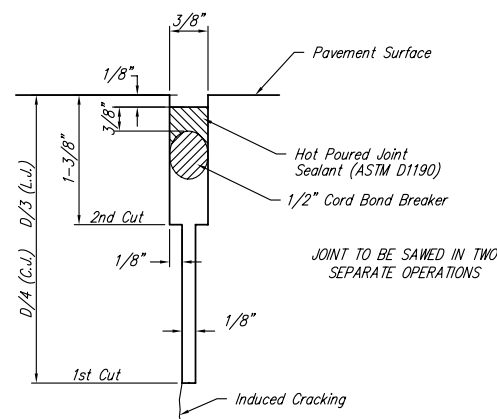

SAW JOINT DETAIL

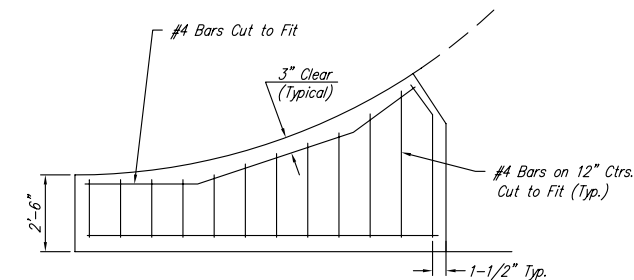

WING REINFORCING DETAIL

H:\CIVIL\03219\DWG\PAV\FOUNDER'S CIRCLE\03219ED4.DWG

		VALLEY GUTTER DETAILS	
JIM ARMOUR, P.E.—ACTING CITY ENGINEER			
PROJECT NUMBER 472-83893		OCA NUMBER 765911	
DATE JAN 2005		SHEET 5 OF 25	
CITY ENGINEER'S OFFICE CITY HALL - SEVENTH FLOOR 455 NORTH MAIN STREET WICHITA, KANSAS 67202 (316) 268-4501 (316) 268-4114 FAX			