

SEAL:

PROPOSED MARKET STREET  
E. ORME STREET E. KELLOGG AVENUE

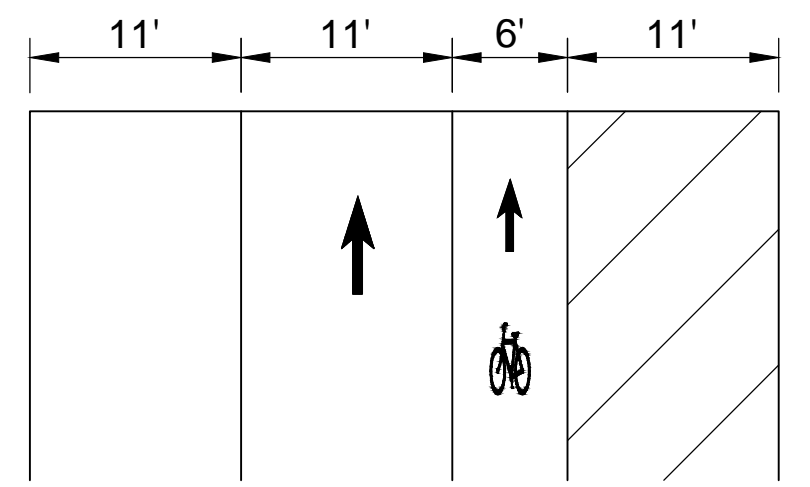

PROPOSED MARKET STREET  
E. KELLOGG AVENUE TO E. KELLOGG DRIVE

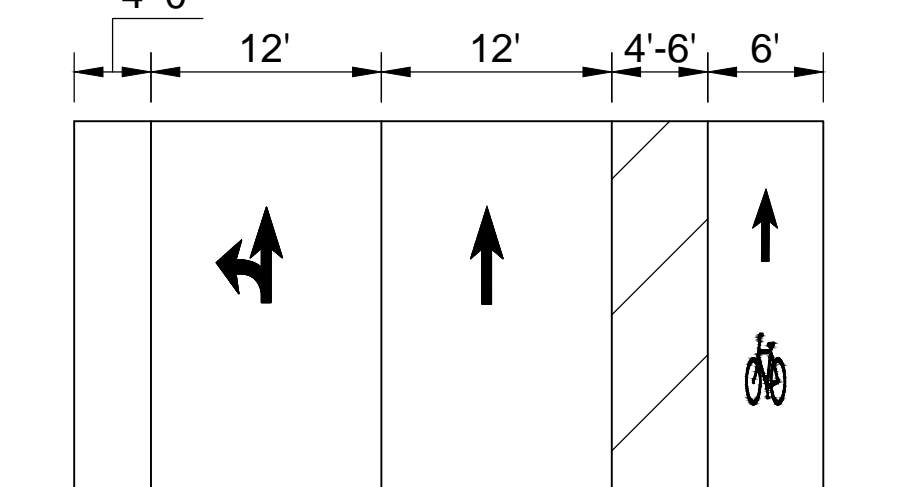

PROPOSED MARKET STREET  
E. KELLOGG DRIVE E. DEWEY STREET

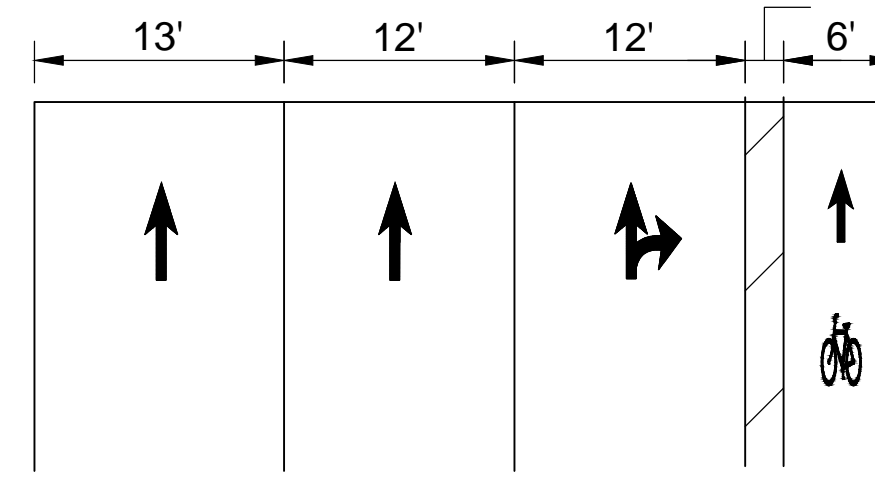

PROPOSED MARKET STREET  
E. DEWEY STREET TO E. LEWIS STREET

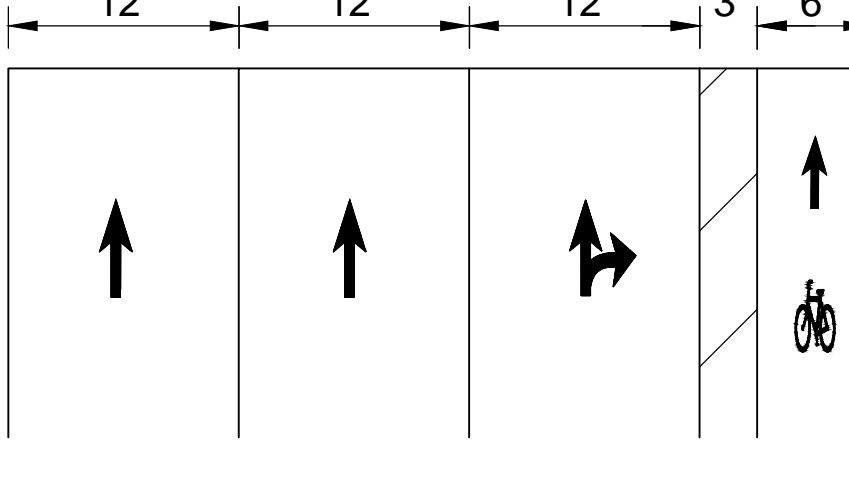

PROPOSED MARKET STREET  
E. LEWIS STREET TO E. WATERMAN STREET

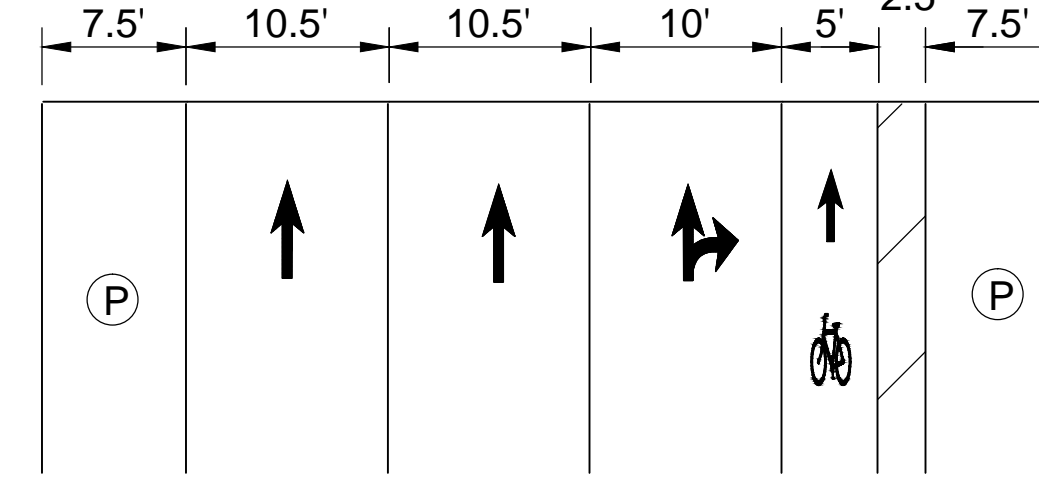

PROPOSED MARKET STREET  
E. WATERMAN STREET TO E. ENGLISH STREET

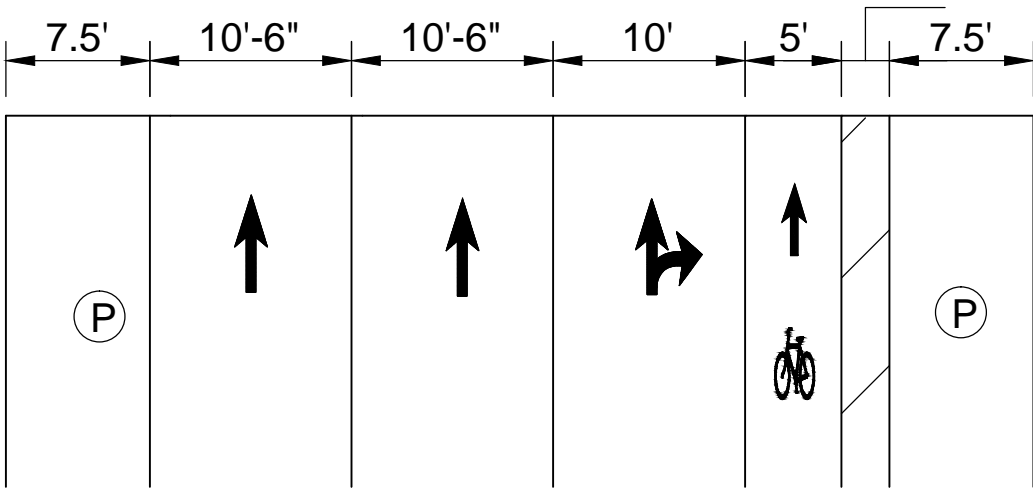

PROPOSED MARKET STREET  
E. ENGLISH STREET TO E. WILLIAMS STREET

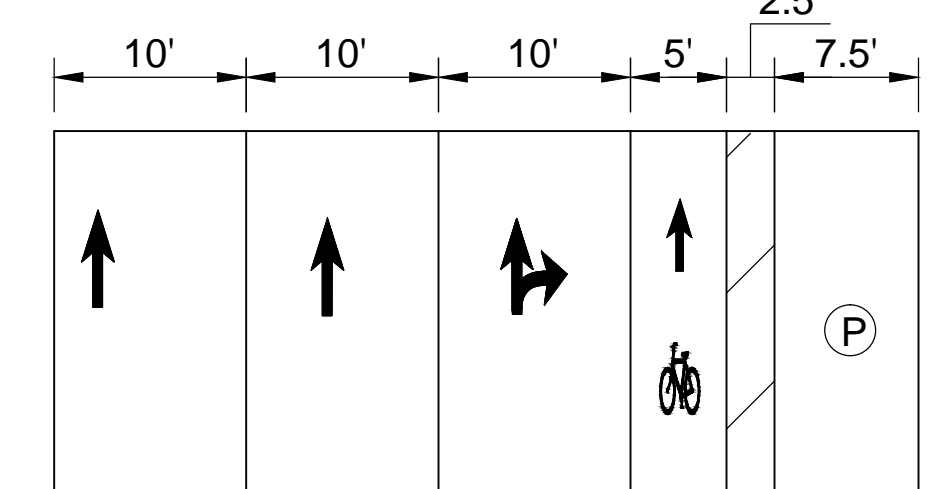

PROPOSED MARKET STREET  
E. WILLIAMS STREET TO E. DOUGLAS STREET

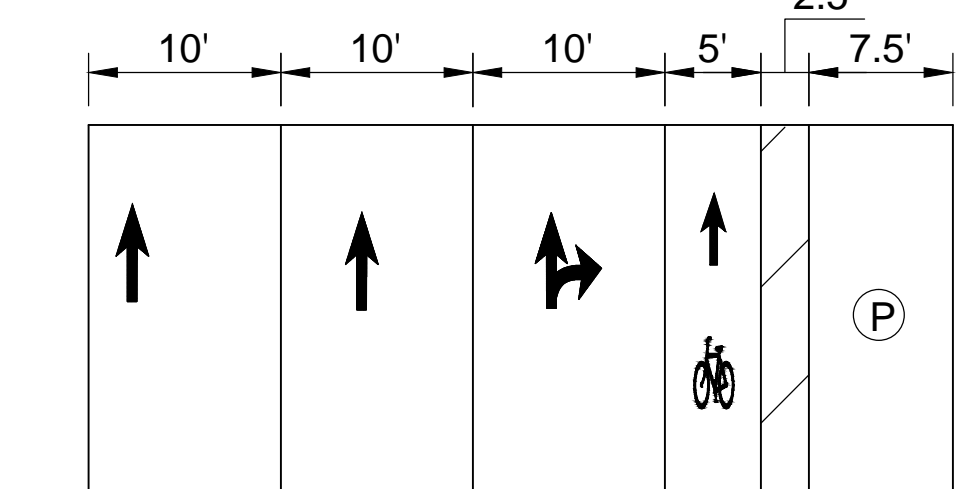

PROPOSED MARKET STREET  
E. DOUGLAS STREET TO E. 1ST STREET

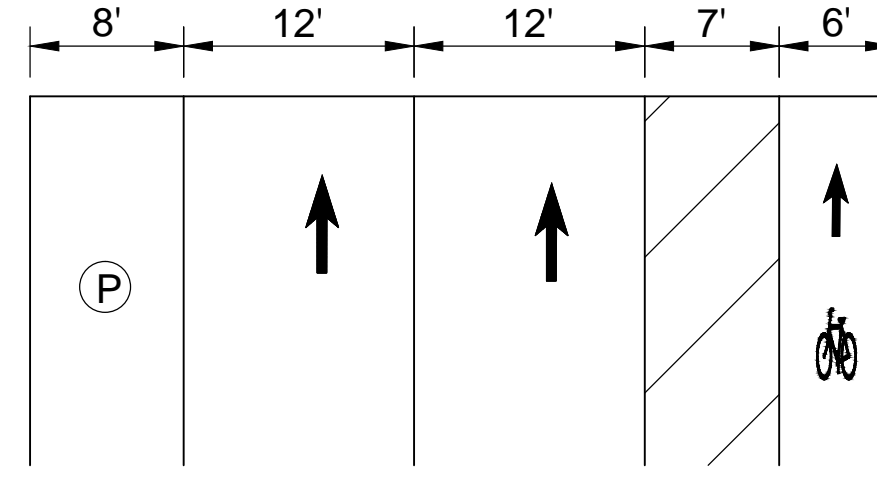

PROPOSED MARKET STREET  
E. 1ST STREET TO E. 2ND STREET

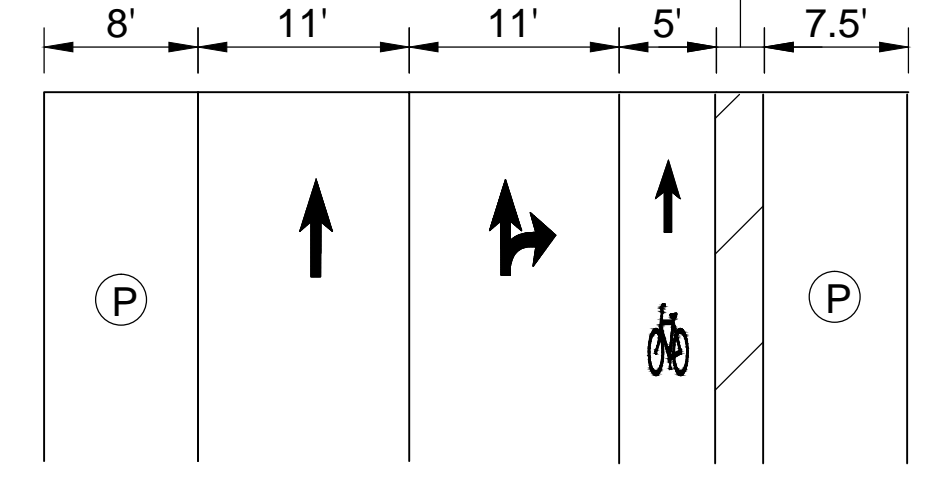

PROPOSED MARKET STREET  
E. 2ND STREET TO E. 3RD STREET

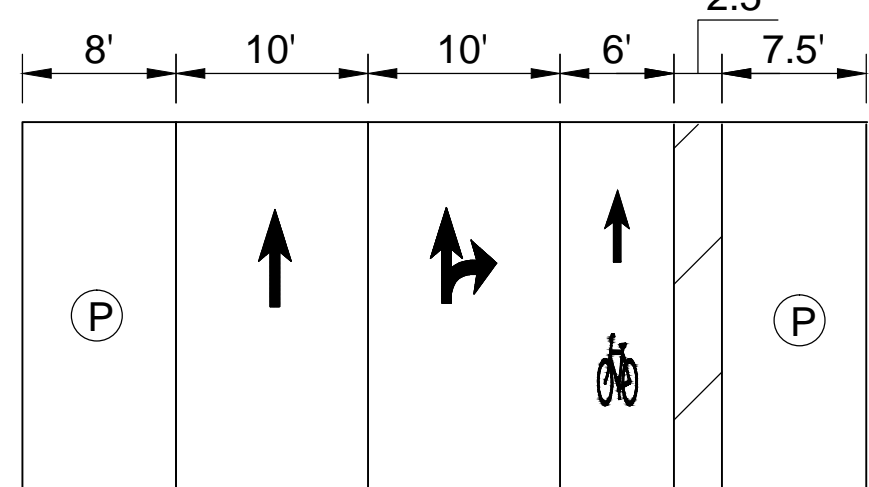

PROPOSED MARKET STREET  
E. 3RD STREET TO E. CENTRAL STREET

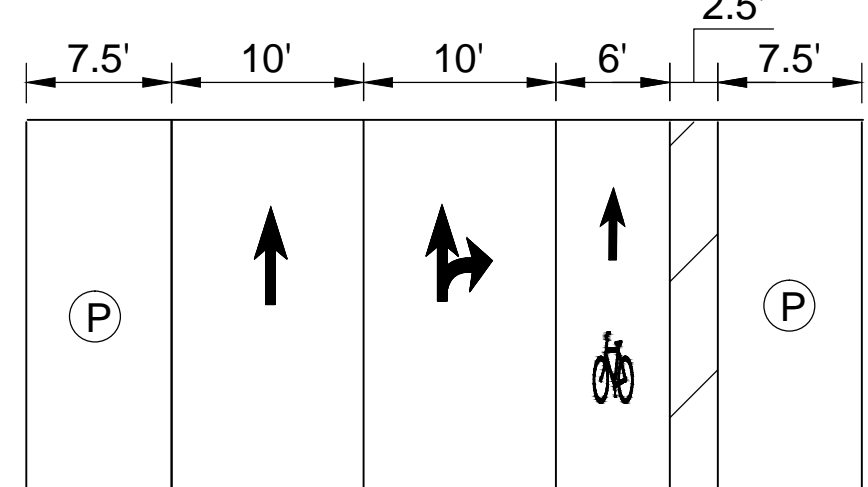

PROPOSED MARKET STREET  
E. CENTRAL STREET TO E. ELM STREET

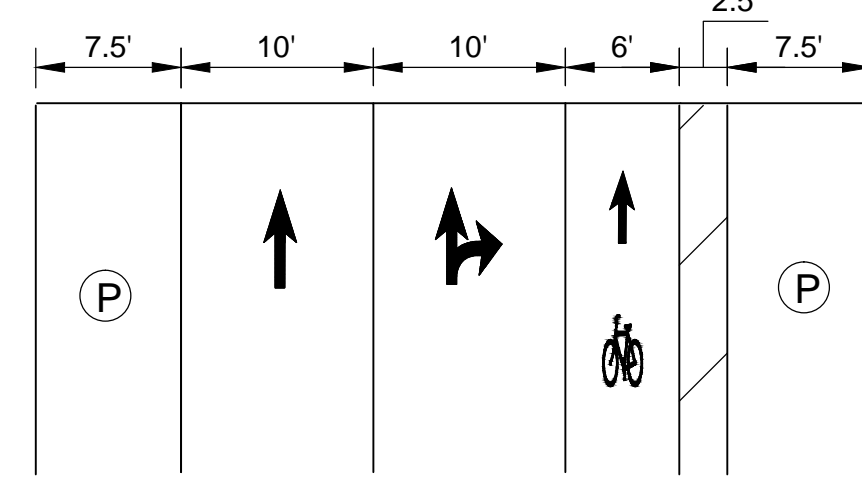

PROPOSED MARKET STREET  
E. ELM STREET TO E. PINE STREET

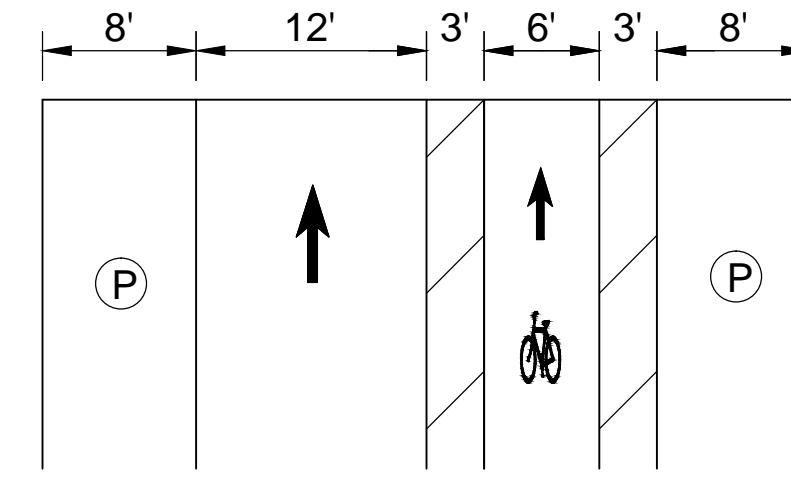

PROPOSED MARKET STREET  
E. PINE STREET TO E. MURDOCK STREET

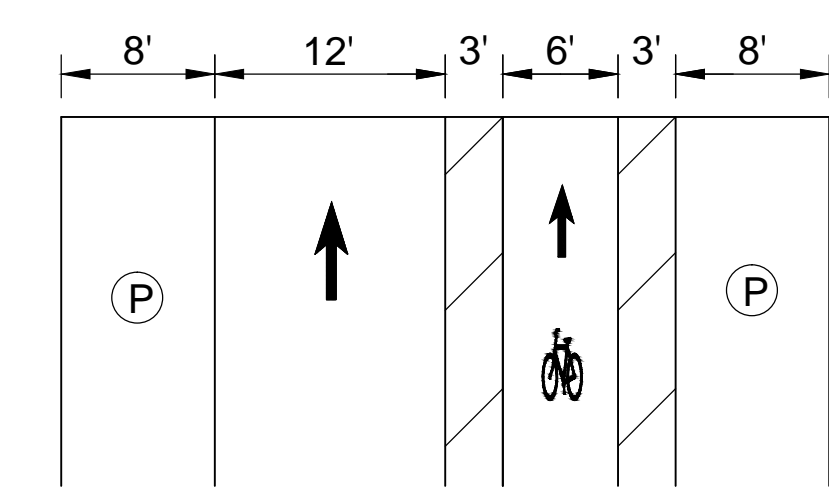

PROPOSED MARKET STREET  
E. MURDOCK STREET TO E. 8TH STREET

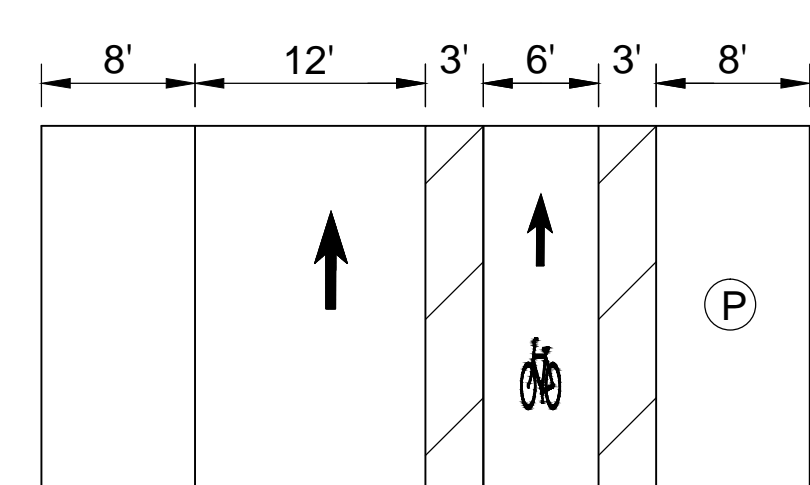

PROPOSED MARKET STREET  
E. 8TH STREET TO E. 9TH STREET

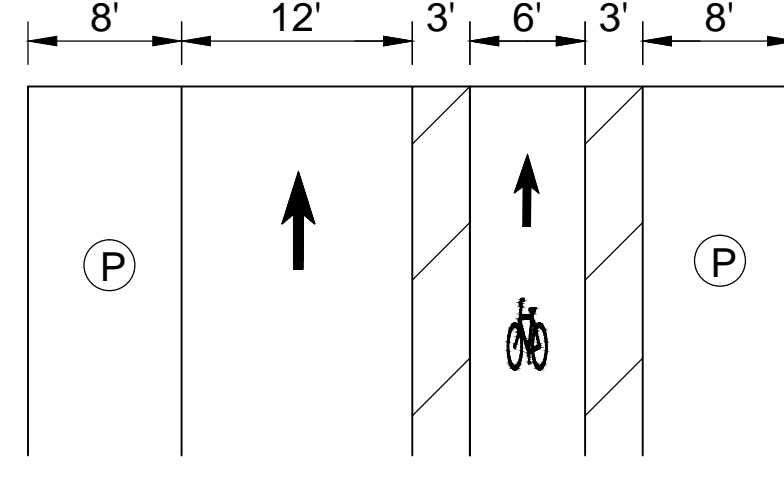

PROPOSED MARKET STREET  
E. 9TH STREET E. TO 10TH STREET

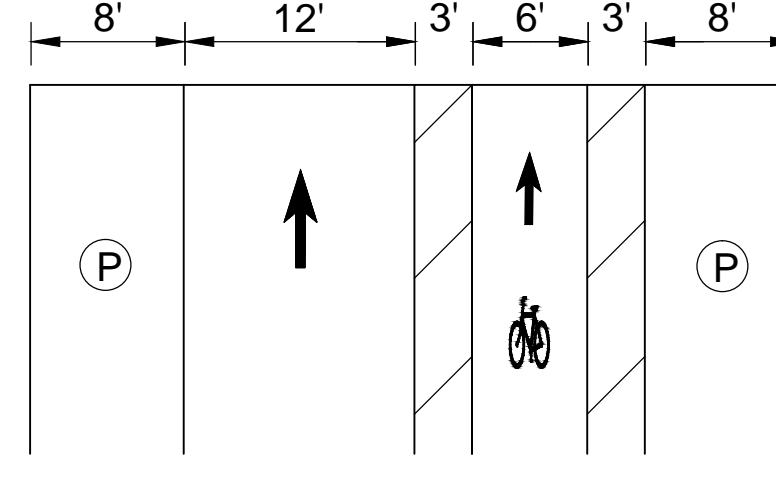

PROPOSED MARKET STREET  
E. 10TH STREET TO E. 11TH STREET

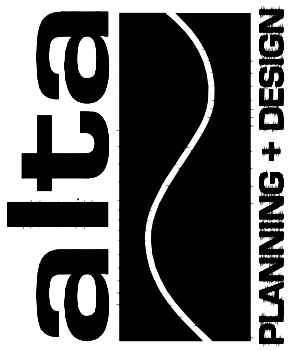
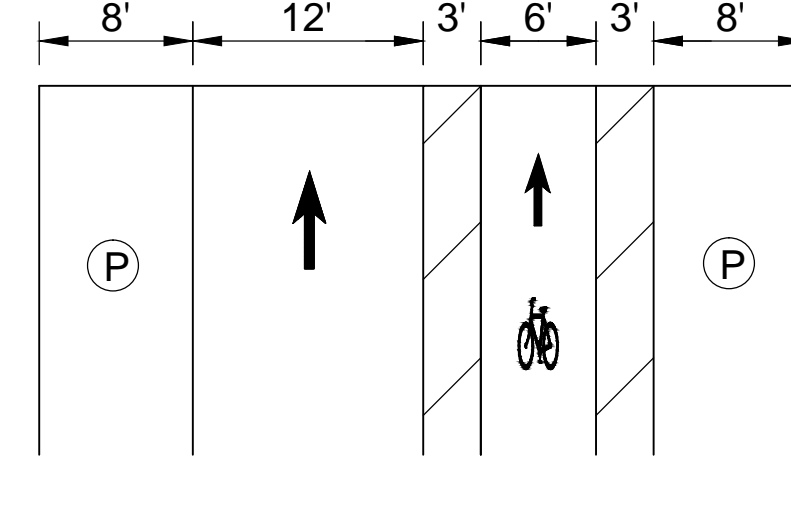

CITY OF WICHITA, KANSAS  
MARKET & TOPEKA STREET  
ON-STREET BIKEWAYS

REVISIONS

PROJECT NUMBER  
87 TE-0397-01

FINAL  
PLANS

SHEET NUMBER:  
TS100

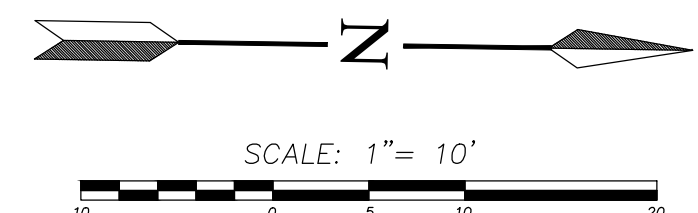

DESIGNED BY: \_\_\_\_\_ CHECKED BY: \_\_\_\_\_  
DRAWN BY: \_\_\_\_\_ DATE: \_\_\_\_\_