

Combined Curb & Gutter (6")

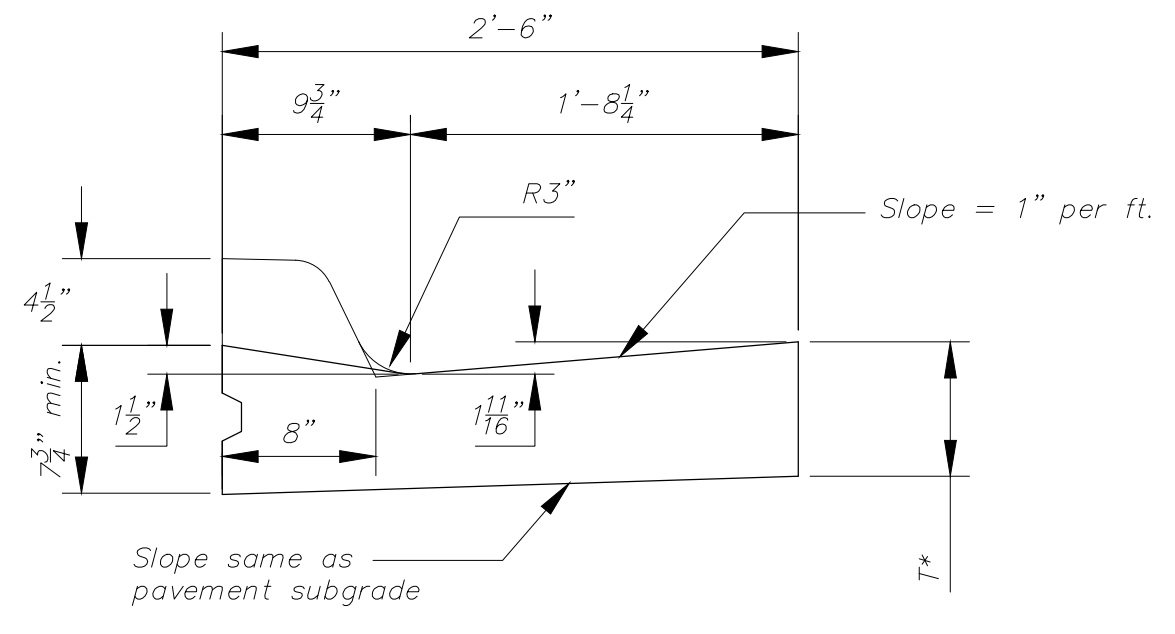

Combined Curb & Gutter (1 1/2")

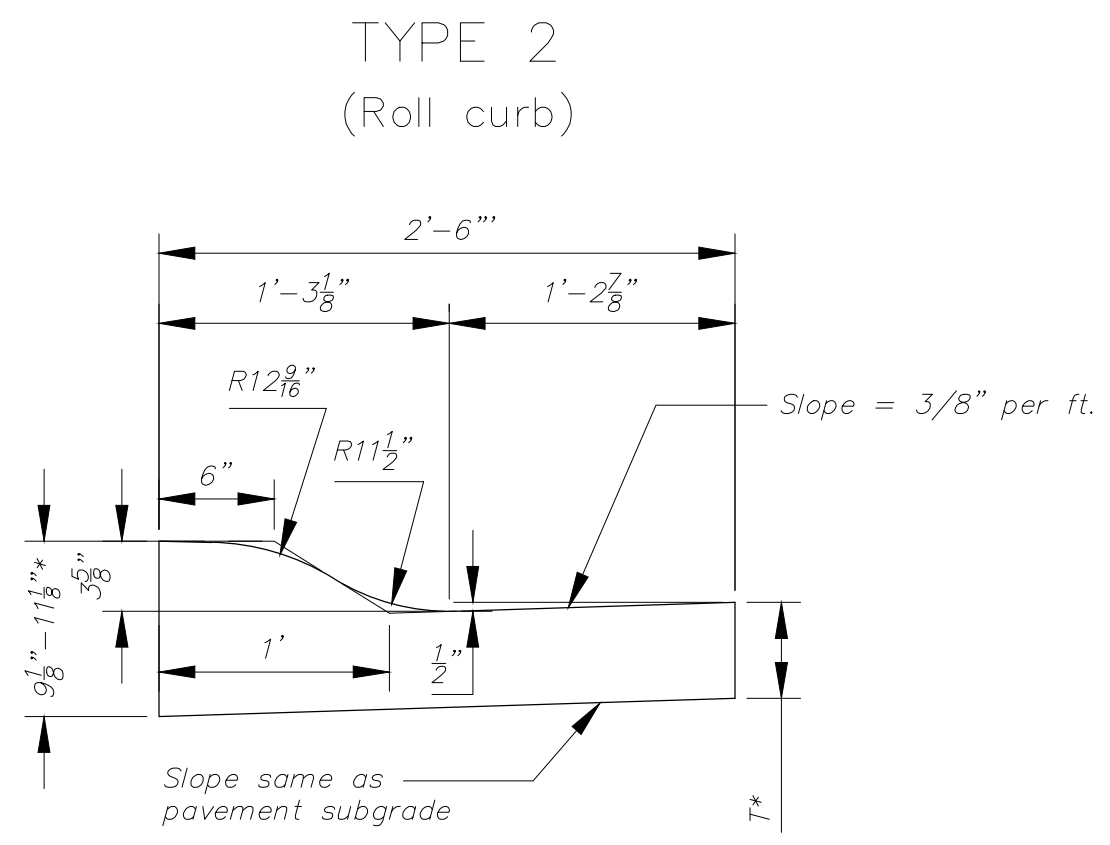

Combined Curb & Gutter (3 5/8")

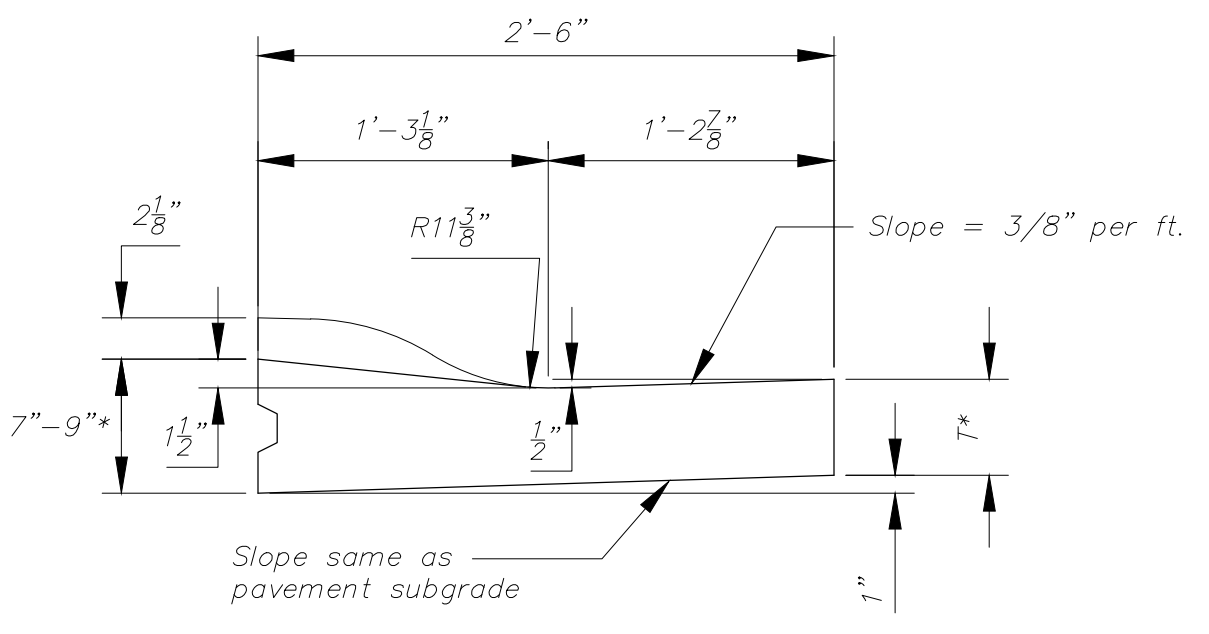

Combined Curb & Gutter (1 1/2")

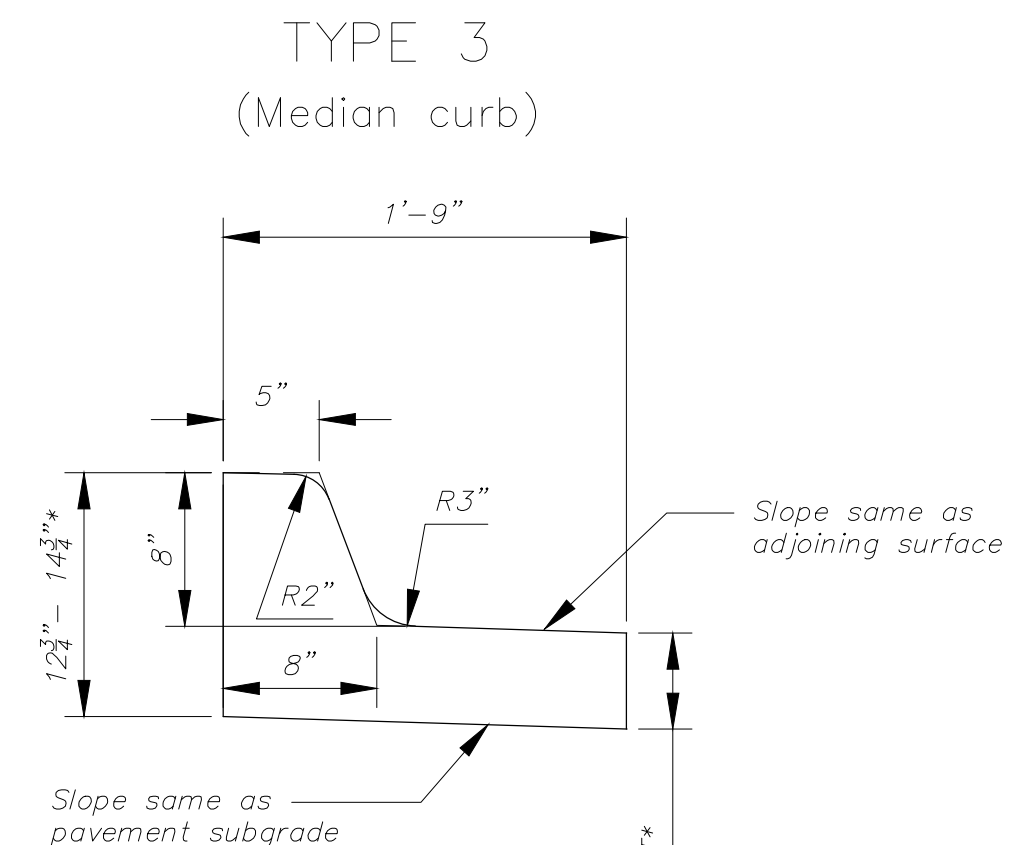

Combined Curb & Gutter (8")

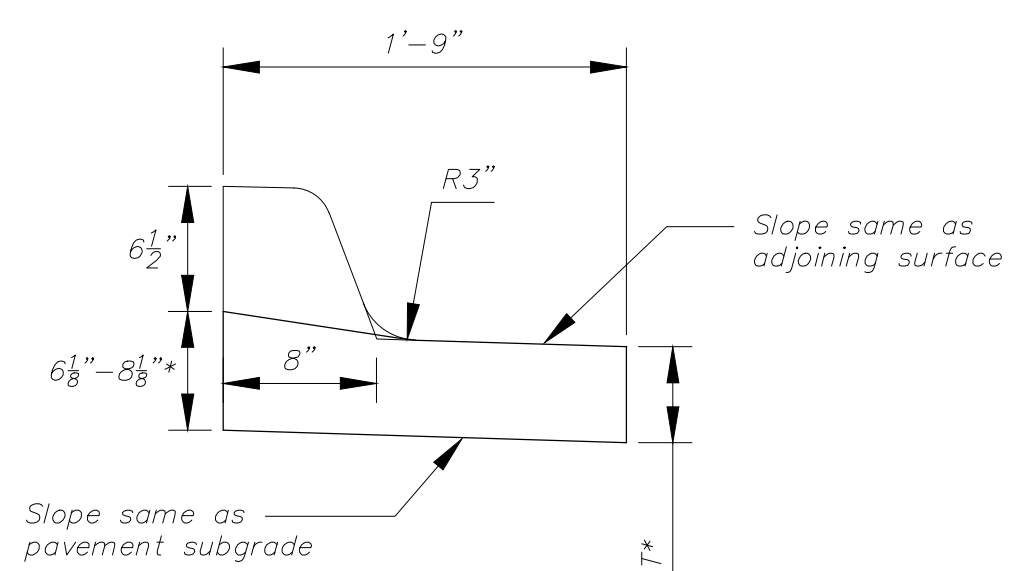

Combined Curb & Gutter (1 1/2")

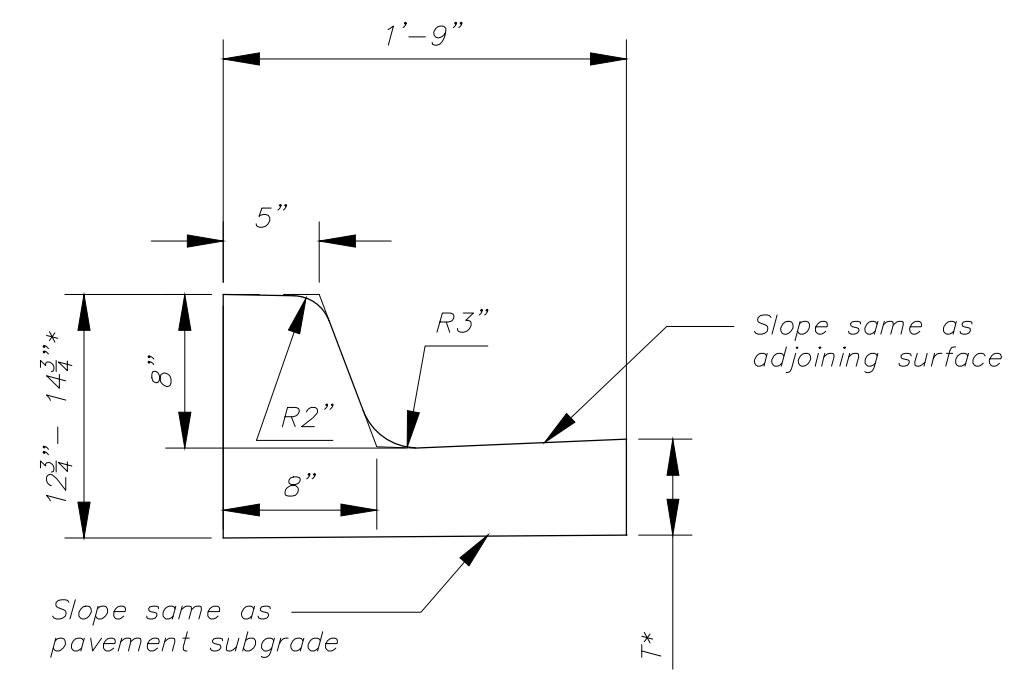

Combined Curb & Gutter (8") High Edge

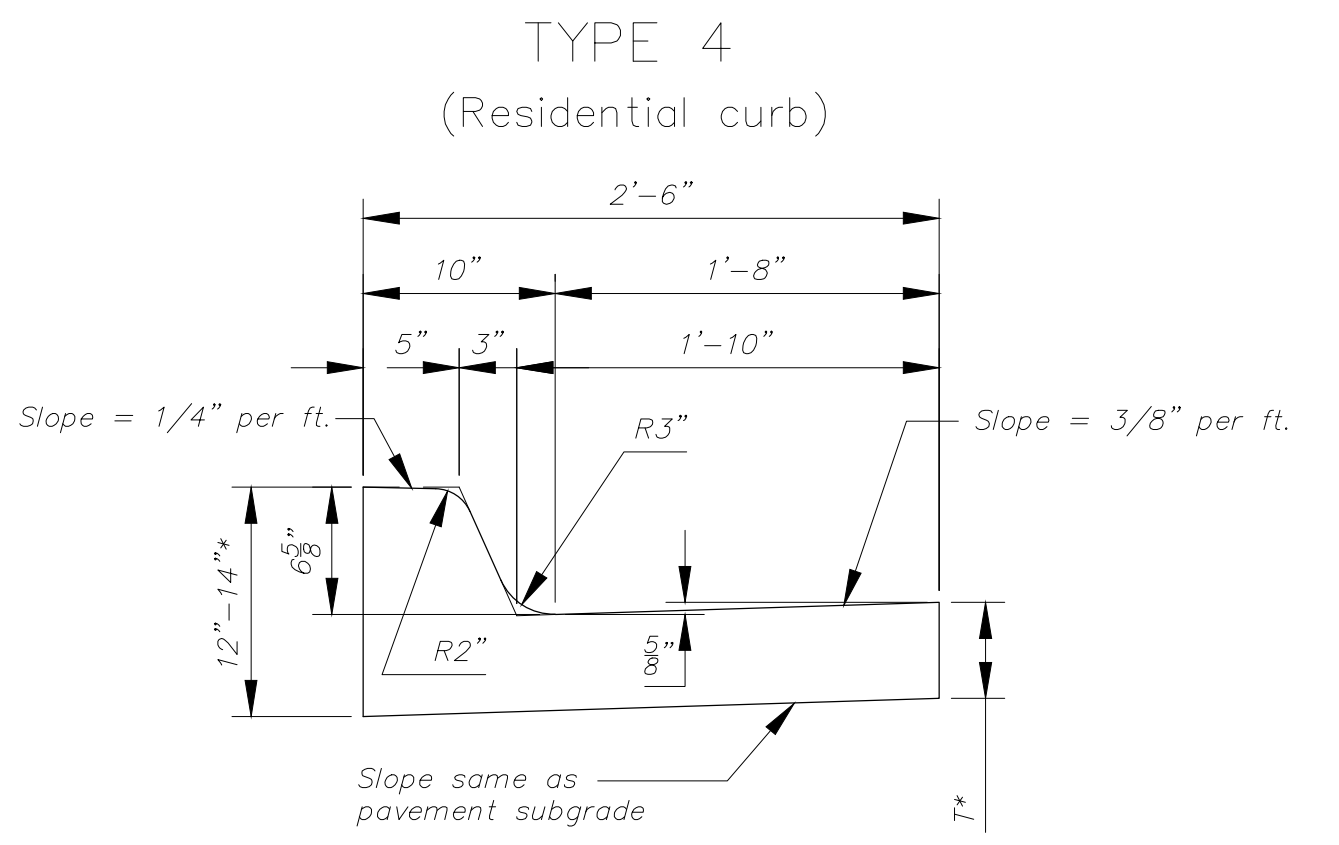

Combined Curb & Gutter (6 5/8")

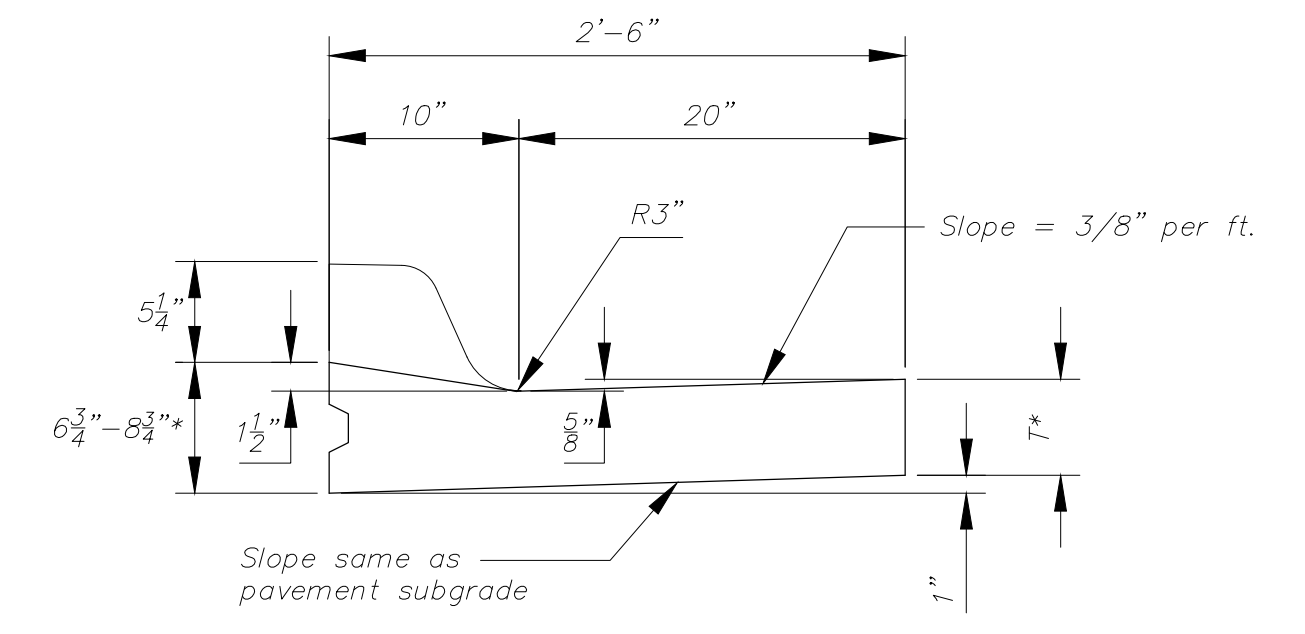

Combined Curb & Gutter (1 1/2")

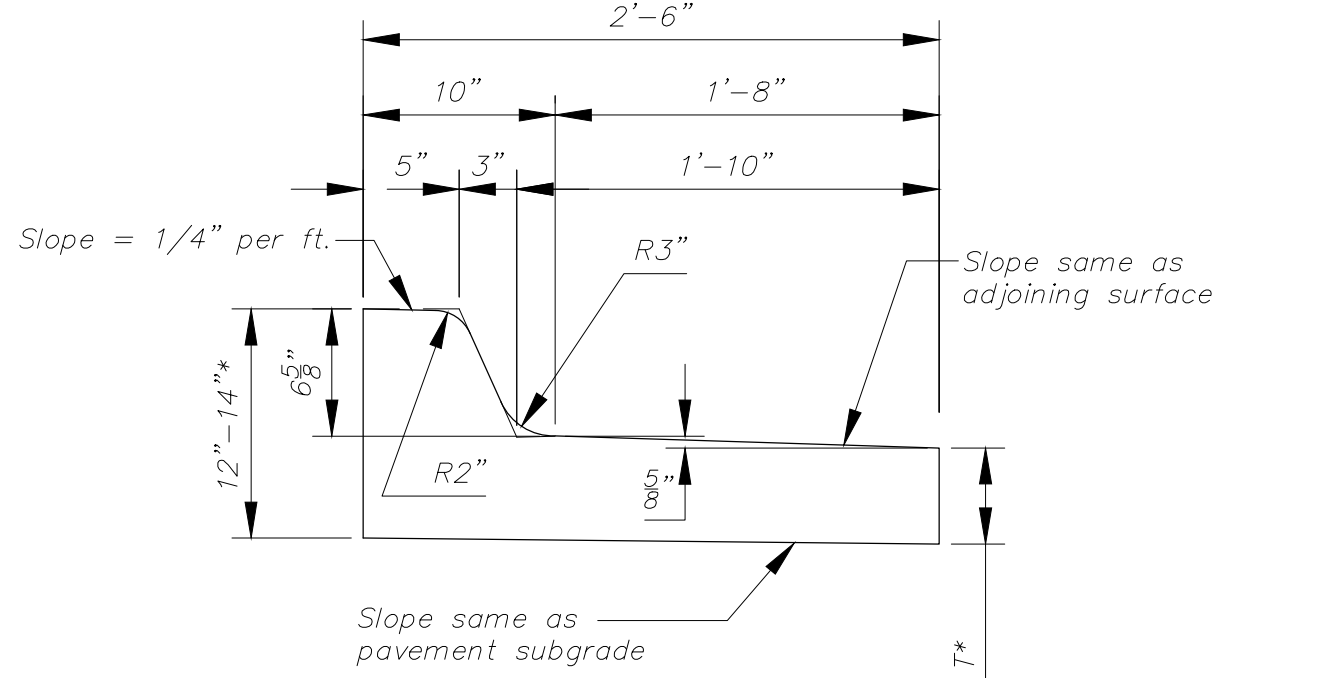

Combined Curb & Gutter (6 5/8") Low Edge

T* = Thickness of curb to adjust with pavement thickness

GENERAL NOTES

- Expansion (isolation) joints shall be constructed a maximum of 300' apart and at all Pls, PCs, cul-de-sac quadrants, and ends of returns.
- Contraction joints shall be constructed a minimum of 12' apart.
- Joint sealer shall be required at all joints on arterial and industrial streets and at intersections on residential streets.

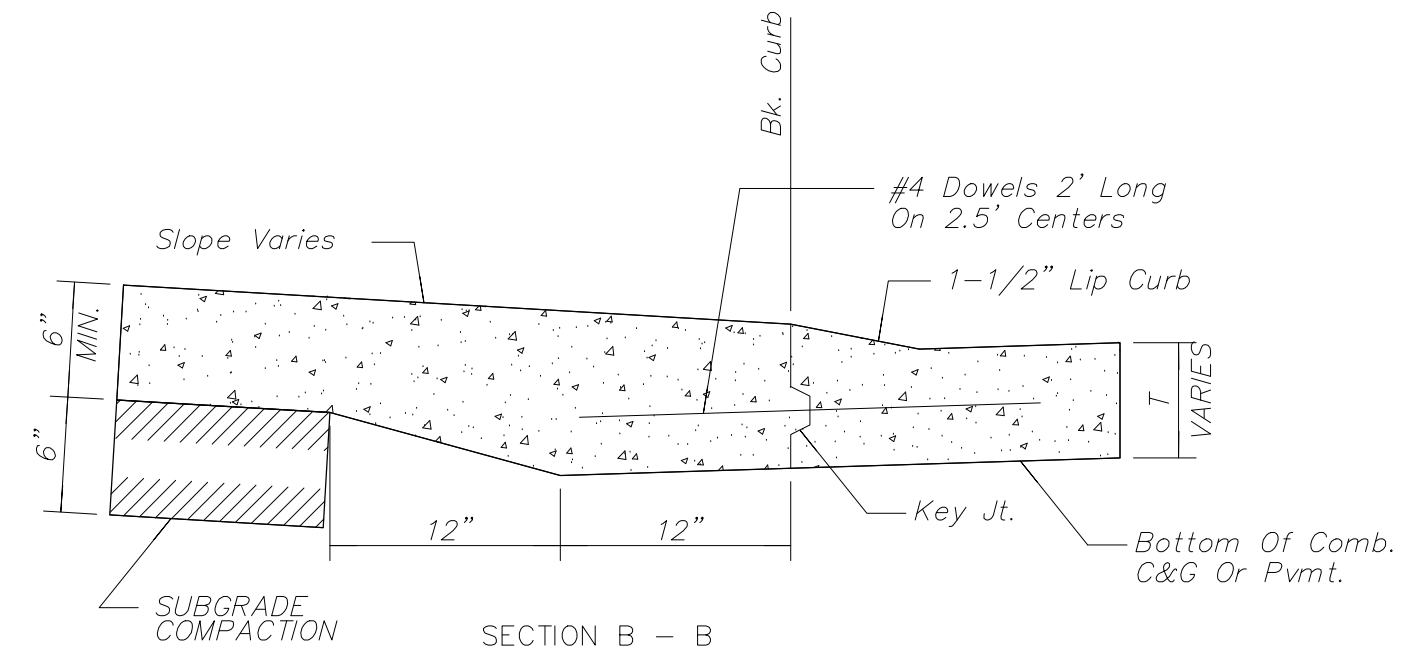

BACK OF CURB DETAIL

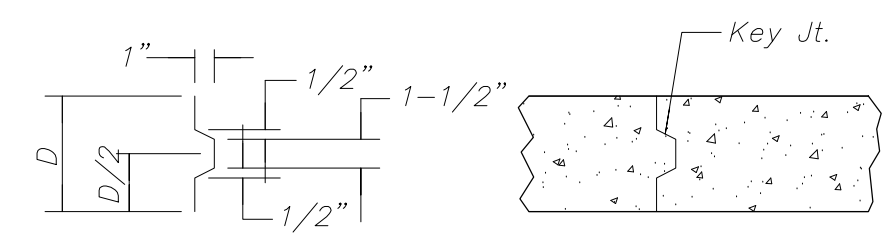

ALT. LONGITUDINAL CONSTRUCTION JOINT

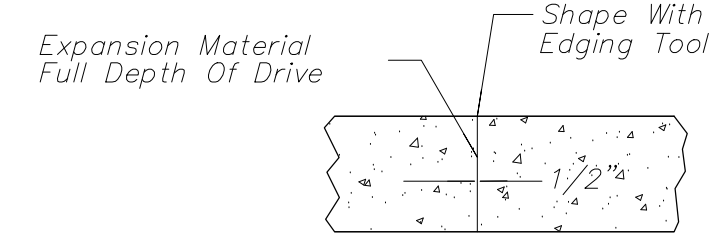

EXPANSION JOINT (E.J.)

CITY OF WICHITA
PUBLIC WORKS & UTILITIES
ENGINEERING DIVISION

CURB & GUTTER DETAILS		
CITY ENGINEER GARY JANZEN, P.E.		
PROJECT NUMBER 472-84192	OCA NUMBER 766372	DATE
CITY ENGINEER'S OFFICE CITY HALL - SEVENTH FLOOR 455 NORTH MAIN STREET WICHITA, KANSAS 67202-1620 (316) 268-4501		3 of 23