

BROOKFIELD ADDITION WICHITA, SEDGWICK COUNTY, KANSAS

- #4 REBAR W/ "BAUGHMAN" CAP (SET)
 - = 1" IRON PIPE (FOUND)
 - ◇ = 2" ALUMINUM "SEDGWICK COUNTY" CAP (FOUND)
 - △ = STONE (FOUND)
 - = #6 REBAR (FOUND)
- (M) = MEASURED
(D) = DESCRIBED
(P) = PLATTED
- BENCHMARK:
CHISELED SQUARE ON E. SIDE OF SCHOOL SIGNAL POLE BASE, W. SIDE OF GREENWICH ROAD, 302' S. & 21.5' W. OF THE SW COR., NW1/4, SEC. 34, TWP. 26-S, R-2-E. ELEV. = 1373.80 NAVD88.
- CHISELED SQUARE ON S. SIDE OF SCHOOL SIGNAL POLE BASE, W. SIDE OF GREENWICH ROAD, 302' S. & 21.5' W. OF THE SW COR., NW1/4, SEC. 34, TWP. 26-S, R-2-E. ELEV. = 1387.64 NAVD88.
- TOP OF 1" IRON PIPE AT NW COR., NW1/4, SEC. 34, TWP. 26-S, R-2-E. ELEV. = 1380.04 NAVD88.

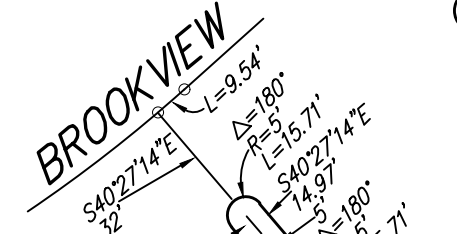
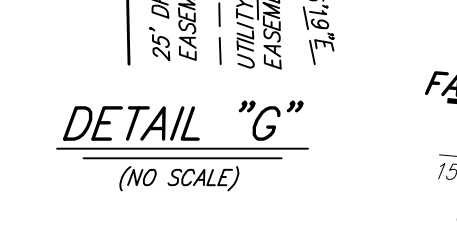
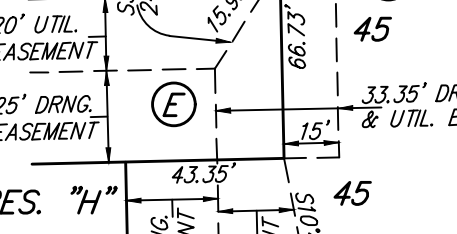
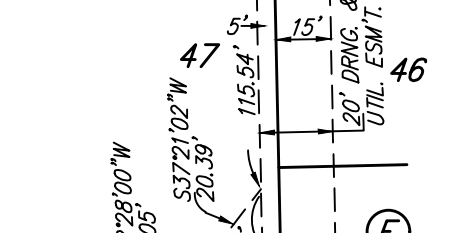
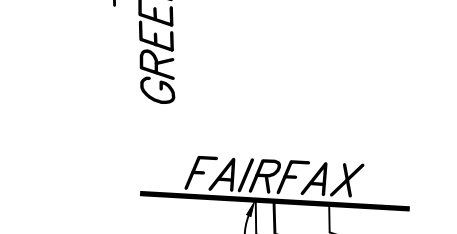
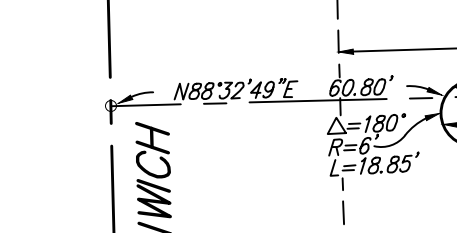
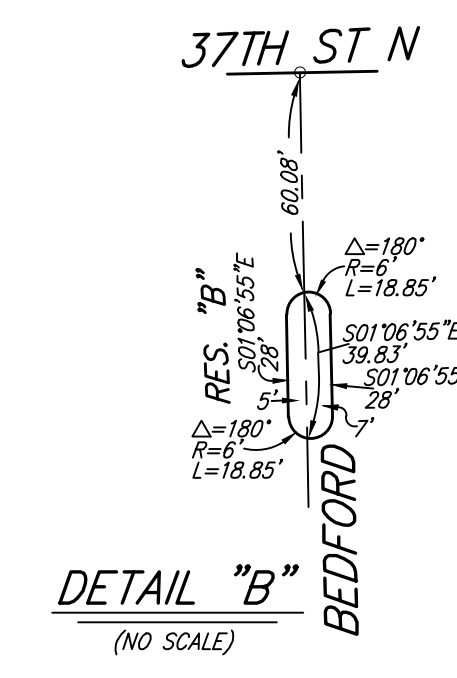
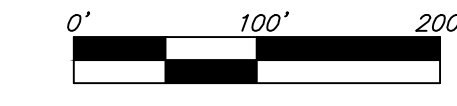
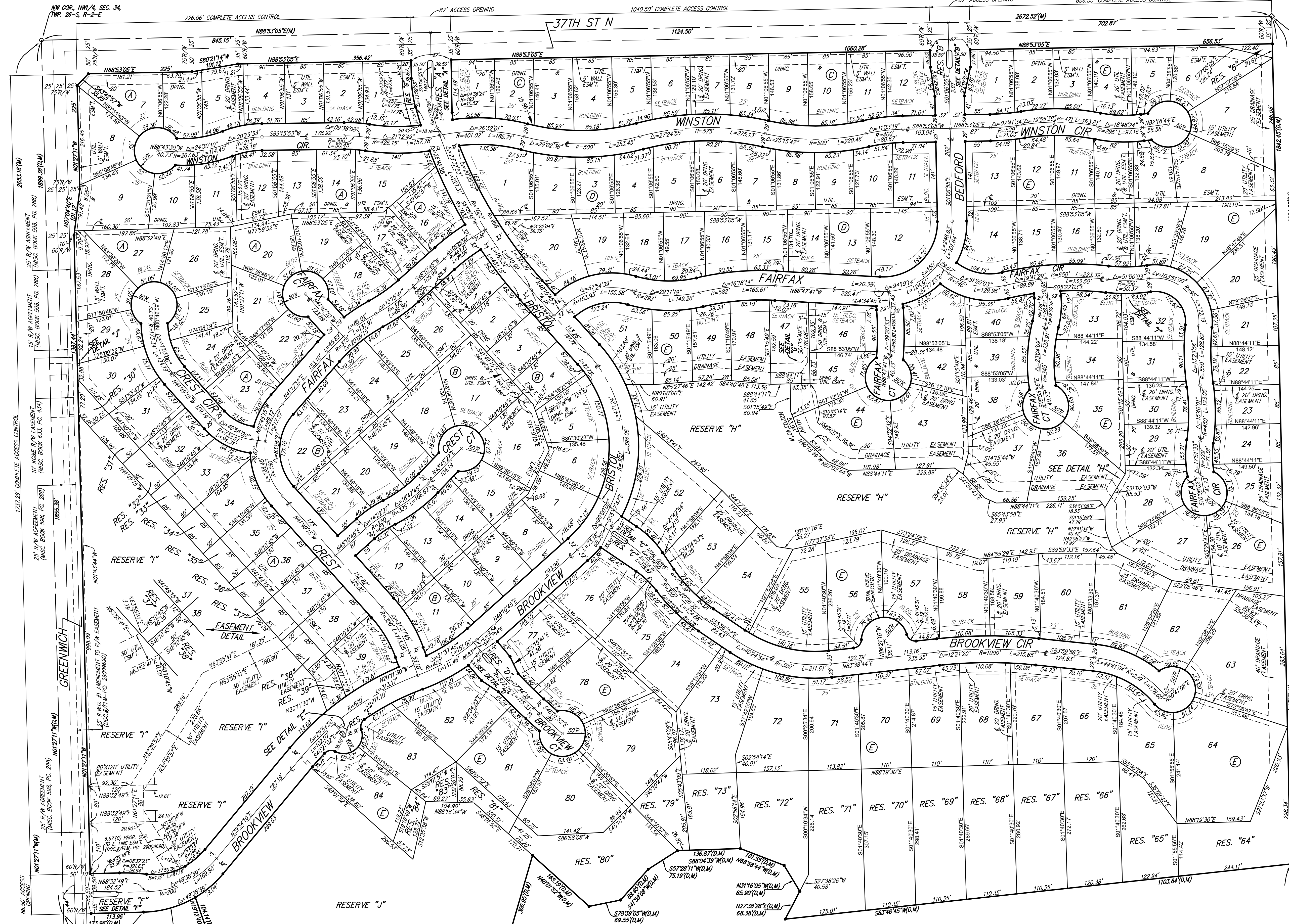

LOT	BLOCK	ELEVATION NAVD88
15-19	A	1376.0
20-22	A	1375.5
23-25	A	1375.0
5-7	F	1377.0
26-28	F	1372.8
30-32	F	1372.5
43-45	F	1372.8
47-51	F	1372.7
52-61	F	1373.0
62	F	1372.5
63-66	F	1370.8
67-71	F	1372.0
72-73	F	1372.7
79-80	F	1373.0
81-84	F	1373.5

NOTE:
A drainage plan has been developed for the plat and all drainage easements, rights-of-way, or reserves shall remain at established grades or as modified with the approval of the applicable City or County Engineer and unobstructed to allow for the conveyance of stormwater.