







LEGEND

-  Phase I
-  Channelizer
-  Type III Barricade
-  Type III Barricade w/ Sign
-  Single Post/Skid Mounted Sign

Note:
 †Type III Barricades and signs are to only be placed during construction through private drive or side street.

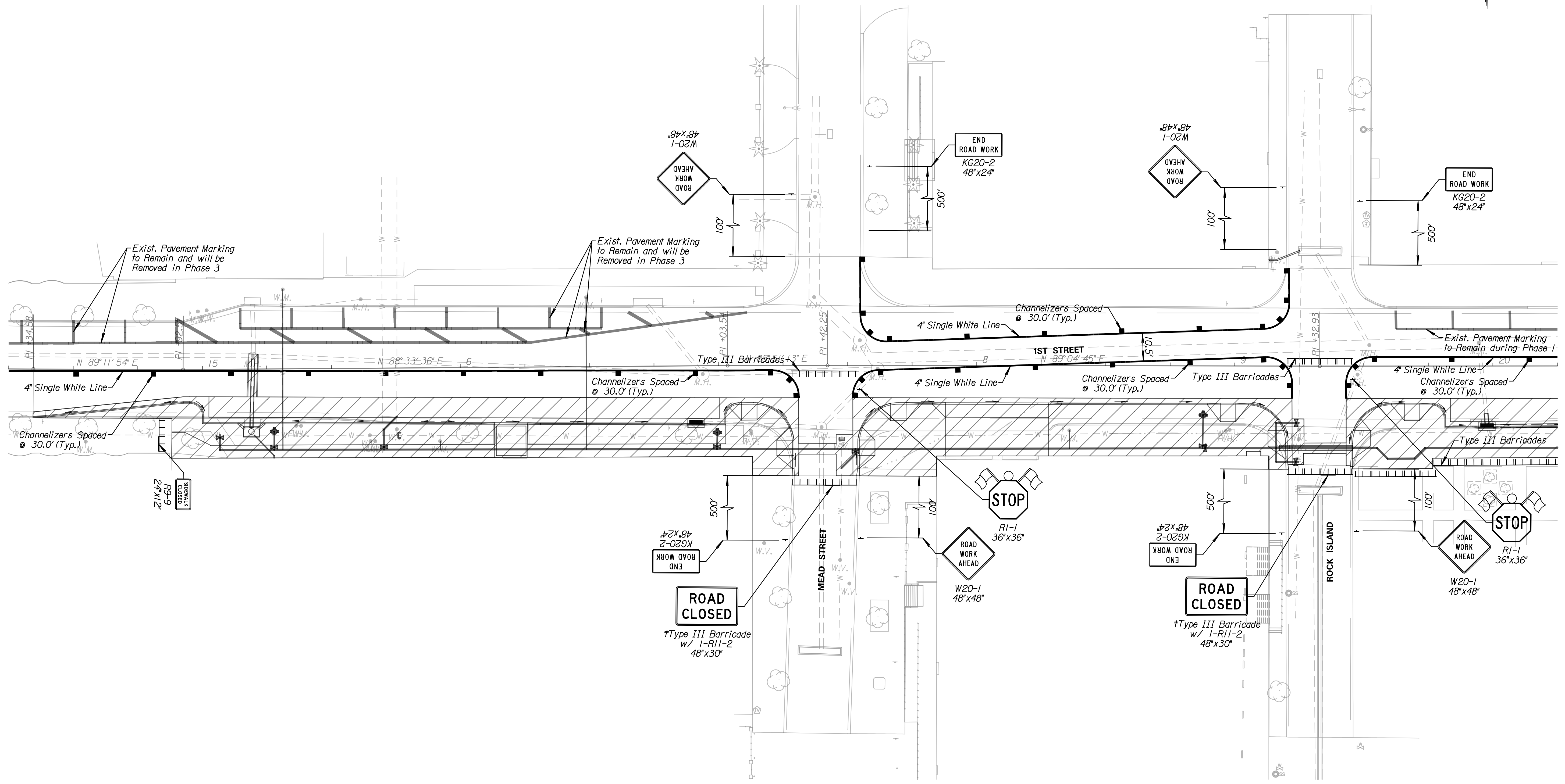
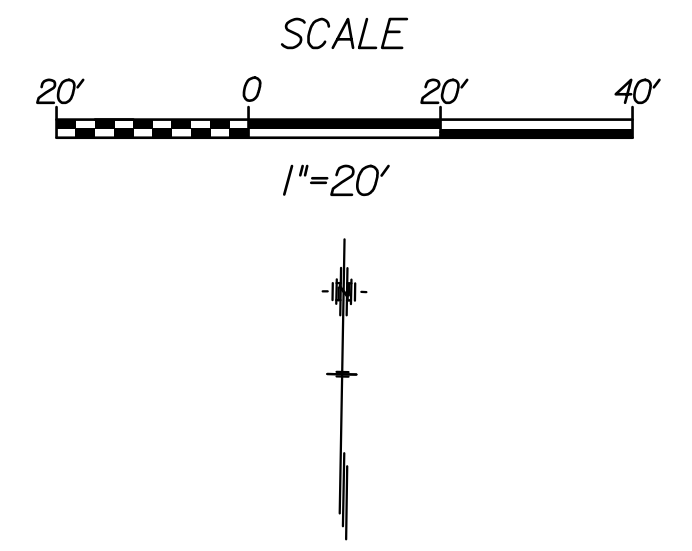

Tran Systems
 245 NORTH WACO
 SUITE 222
 WICHITA, KANSAS 67202
 PHONE: 316-303-3000
 FAX: 316-303-0156

CONSULTANTS:

 LK ARCHITECTURE, INC.
 345 RIVERVIEW
 SUITE 200
 WICHITA, KANSAS 67208
 PHONE: 316-268-0230

1ST STREET IMPROVEMENTS
 SANTA FE TO WASHINGTON IN OLD TOWN
 WICHITA, KANSAS

REVISIONS:	MARK	DATE	DESCRIPTION

PROJ NO: 472-85285
 SCALE: 1"=20'
 DATE: 7/5/2017
 DESIGNED BY: TAU
 DRAWN BY: TAU
 CHECKED BY: MDB

SHEET TITLE:
**1ST STREET IMPROVEMENTS
 TRAFFIC CONTROL
 PHASE 1**

SHEET NO.
53
 SHEET 53 OF 90

taumdel
 7/5/2017
 - 3:57:52 PM - c:\transtransystems\paw_bocalltranstransystems\paw\taumdel\0482731C-CPP-M01-102.dgn