

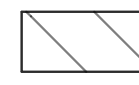







LEGEND

-  Phase 4
-  Single Post/Skid Mounted Sign
-  Channelizer
-  Tubular Marker (36")
-  Type III Barricade
-  Type III Barricade w/ Sign
-  Portable Changeable Message Board
-  Pavement Marking Removal

Note:
 *Type III Barricades and signs are to only be in place during construction through the private drive or side street
 At minimum one (1) entrance to Quiktrip shall remain open at all times

Typical Section Phase 4

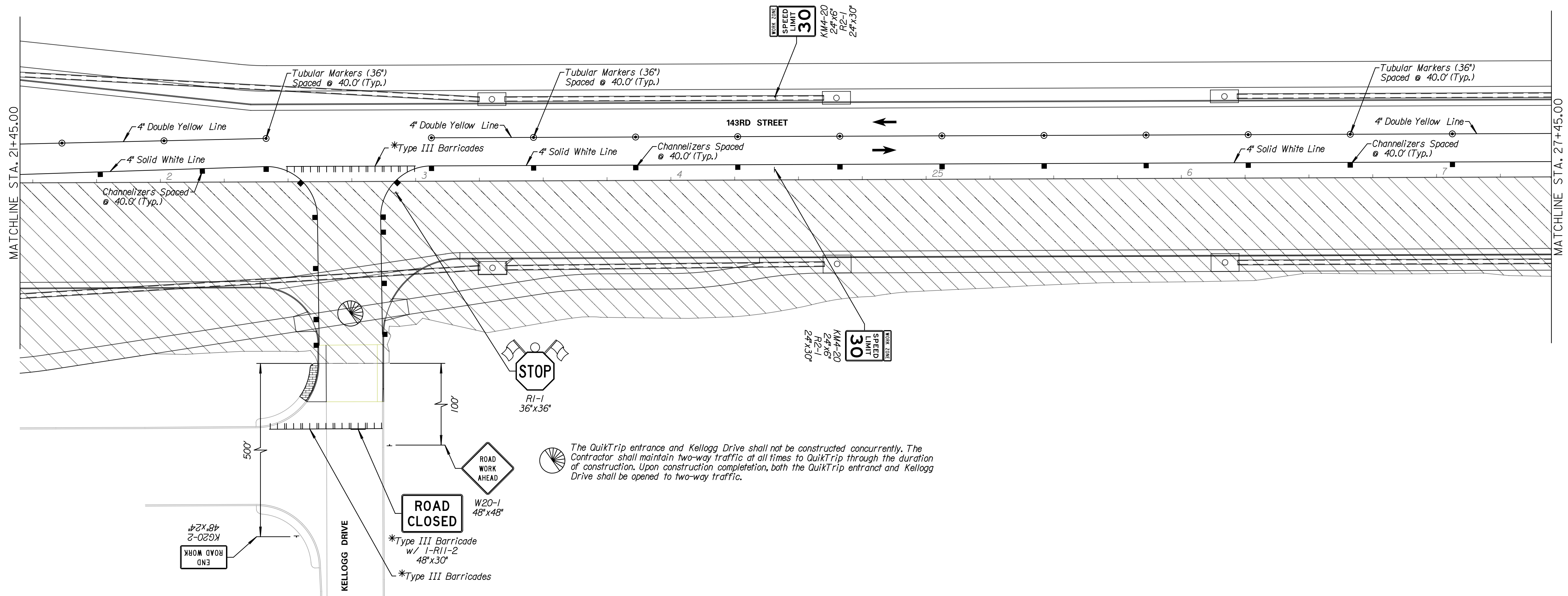
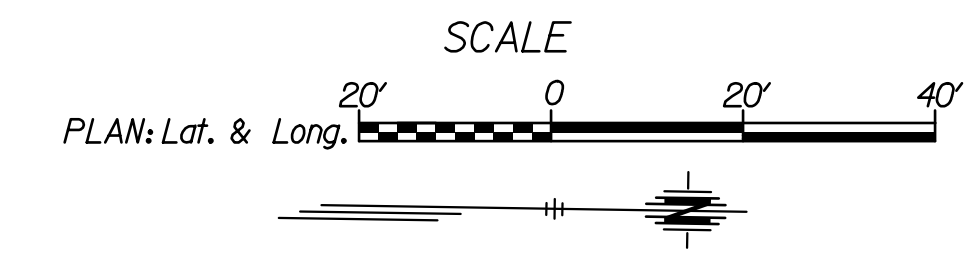
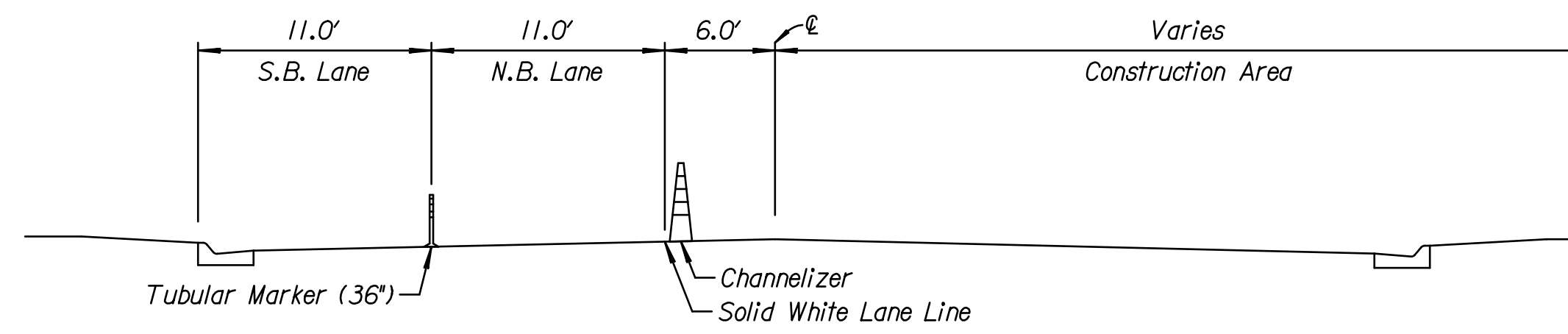

Tran Systems
 245 NORTH WACO
 SUITE 222
 WICHITA, KANSAS 67202
 PHONE: 316-303-3000
 FAX: 316-462-5629

CONSULTANTS:

143RD STREET IMPROVEMENTS
 WICHITA, KANSAS

REVISIONS:	DESCRIPTION	DATE	MARK

PROJ NO: 87 N-0614-01
 SCALE: 1"=20'
 DATE: 5/26/2017
 DESIGNED BY: TAU
 DRAWN BY: TAU
 CHECKED BY: MDB

SHEET TITLE:
143RD STREET IMPROVEMENTS TRAFFIC CONTROL PHASE 4

SHEET NO.
105

5/26/2017 11:13:44 AM c:\transtrans\systems\paw_bocalltrans\systems\paw_bocalltrans\228400C-CPP-M01-203.DGN