







LEGEND

-  Phase 1a
-  Single Post/Skid Mounted Sign
-  Channelizer
-  Tubular Marker (36")
-  Type III Barricade
-  Type III Barricade w/ Sign
-  Portable Changeable Message Board
-  Pavement Marking Removal

Note:
K1-104a and K1-105a shall be placed in the appropriate locations. For more details on K1-104a and K1-105a signs and sign placements, See Sheet 87

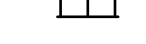
The Contractor shall see the detour overview maps for more information on the overall traffic control layout for the project. See Sheets 69 & 70

The Contractor may alter the arrangement of any traffic control devices deemed necessary for the progress of the project. All changes shall be submitted to the Engineer for approval prior to the rearranging of devices.

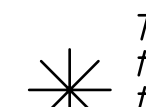
 The Contractor shall maintain access to the property owner through the duration of the project. During construction the entrance shall be constructed half at a time or other means of access shall be utilized during the time the entrance is being constructed

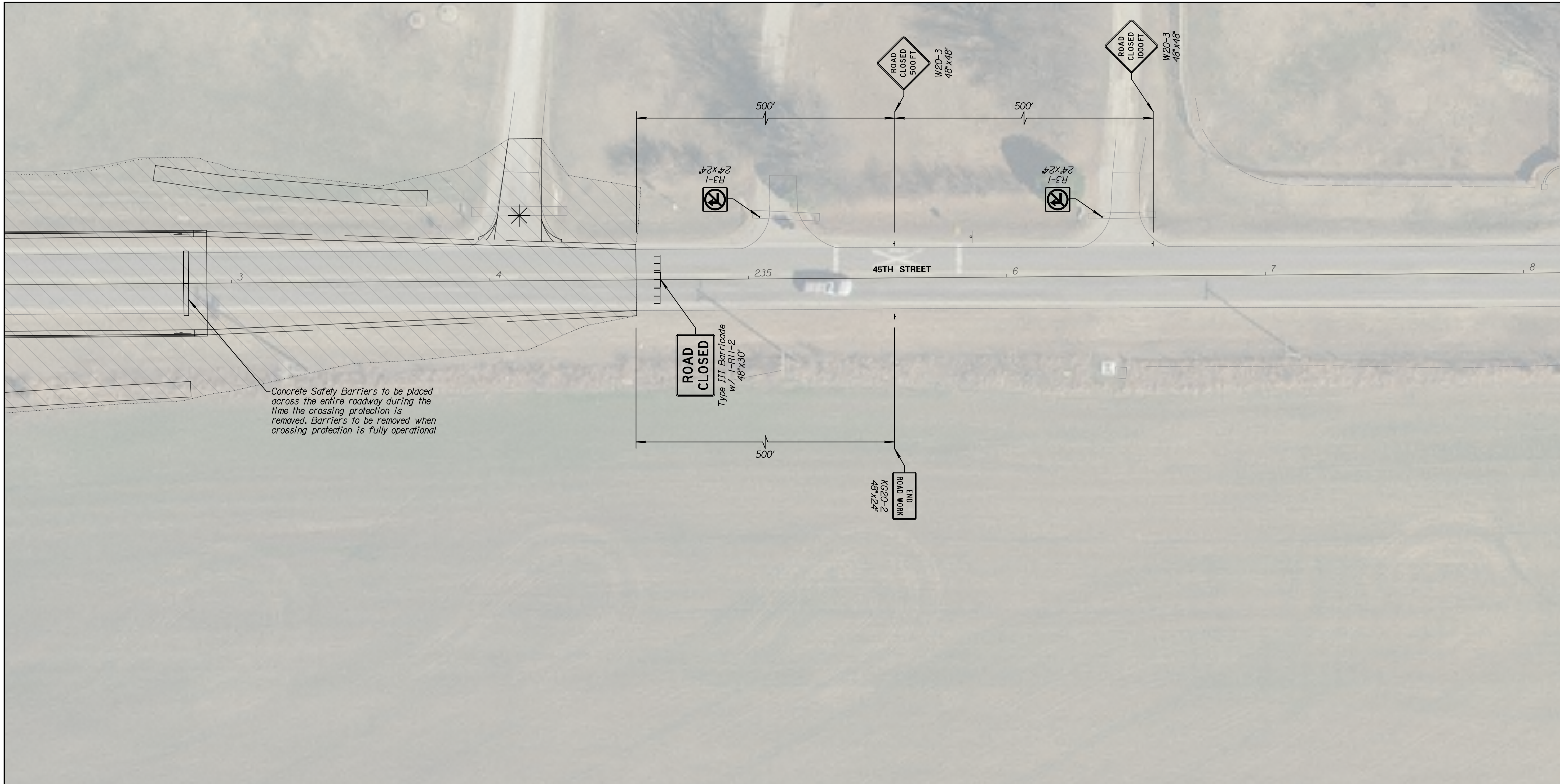
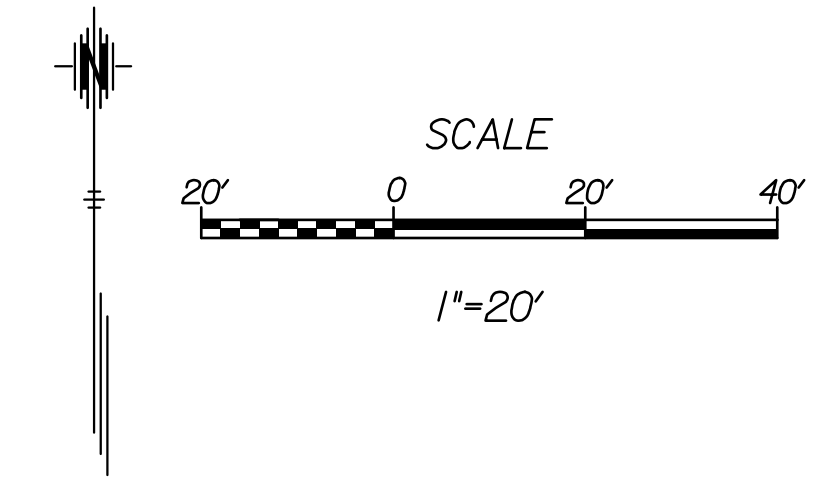

Tran Systems
 245 NORTH WACO
 SUITE 222
 WICHITA, KS 67202
 PHONE: 316-303-3000
 FAX: 316-303-0156

CONSULTANTS:

45TH & HILLSIDE
 INTERSECTION IMPROVEMENT



REVISIONS:	MARK	DATE	DESCRIPTION

PROJ NO: 87 N-0616-01
 SCALE: 1"=20'
 DATE: 10/9/2017
 DESIGNED BY: TAU
 DRAWN BY: TAU
 CHECKED BY: MDB

SHEET TITLE:
TRAFFIC CONTROL PHASE 1A

SHEET NO.
72
 SHEET 72 OF 166

10/9/2017 1:36:34 PM - c:\tran\systems\paw_bocall\transys\paw\taummet\0258284c-cpp-m01-103.dgn