

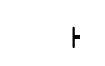





LEGEND

-  Phase 1b
-  Single Post/Skid Mounted Sign
-  Channelizer
-  Tubular Marker (36")
-  Type III Barricade
-  Type III Barricade w/ Sign
-  Portable Changeable Message Board
-  Pavement Marking Removal

Note:
The Contractor shall see the detour overview maps for more information on the overall traffic control layout for the project. See Sheets 69 & 70

The Contractor may alter the arrangement of any traffic control devices deemed necessary for the progress of the project. All changes shall be submitted to the Engineer for approval prior to the rearranging of devices.

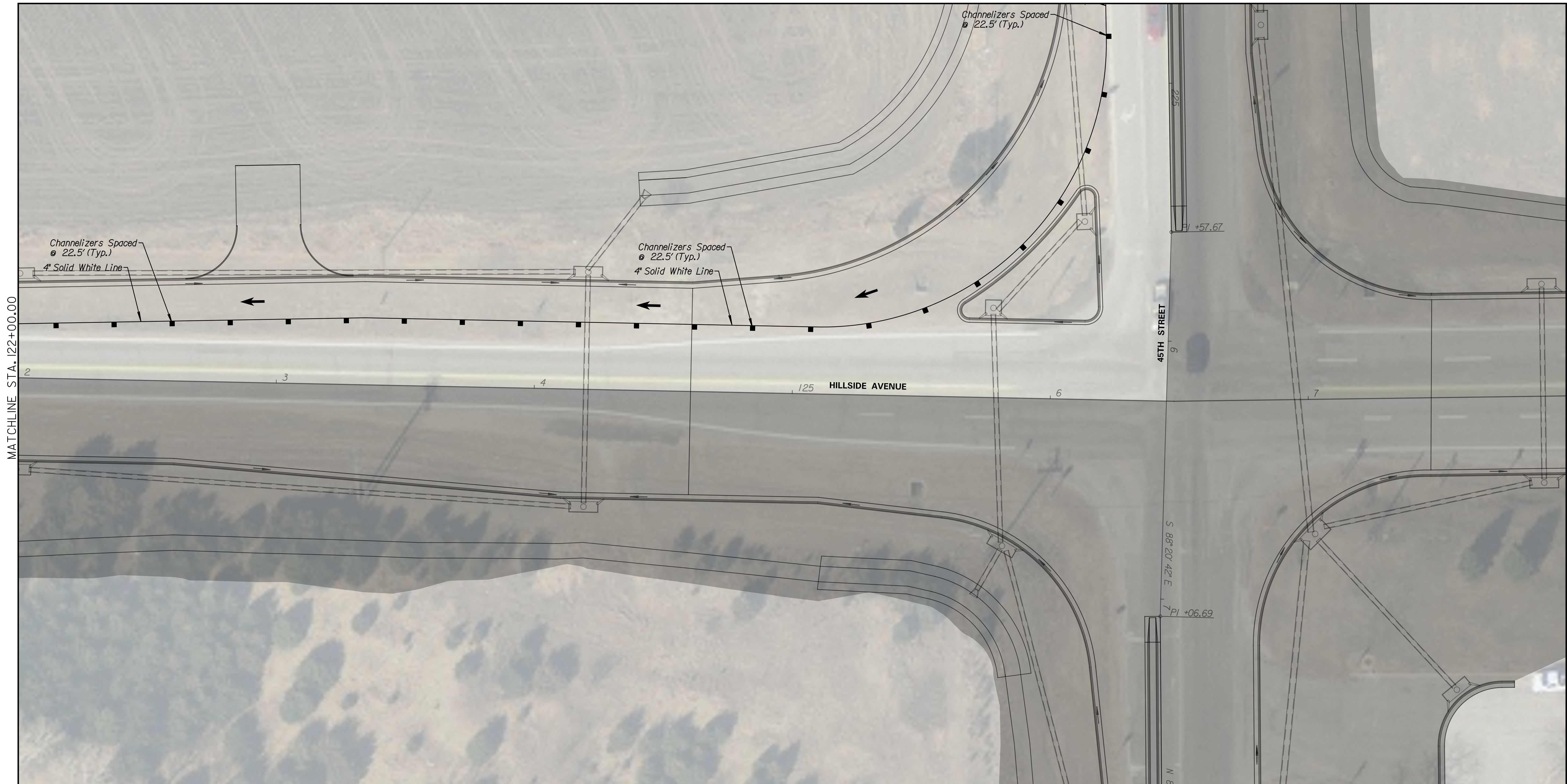
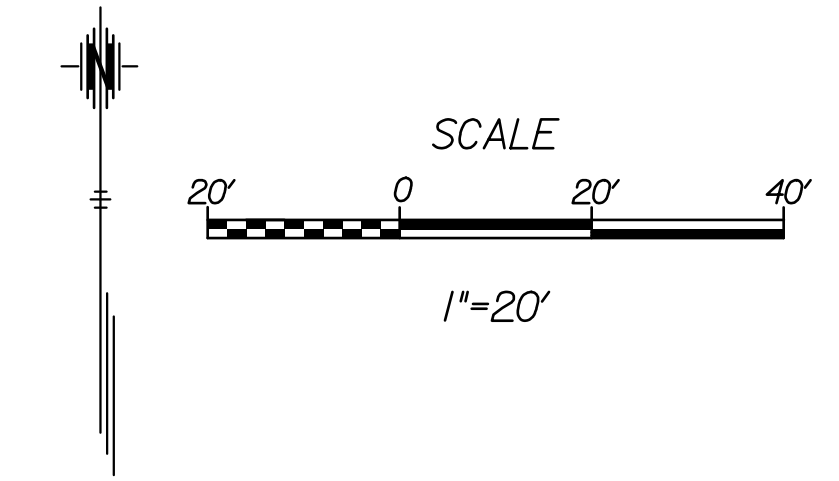

Tran Systems
 245 NORTH WACO
 SUITE 222
 WICHITA, KS 67202
 PHONE: 316-303-3000
 FAX: 316-303-0156

CONSULTANTS:

45TH & HILLSIDE
 INTERSECTION IMPROVEMENT



REVISIONS:	MARK	DATE	DESCRIPTION

PROJ NO: 87 N-0616-01
 SCALE: 1"=20'
 DATE: 10/9/2017
 DESIGNED BY: TAU
 DRAWN BY: TAU
 CHECKED BY: MDB

SHEET TITLE:
TRAFFIC CONTROL PHASE 1B

SHEET NO.
82

SHEET 82 OF 166

10/9/2017 1:22:28 PM - c:\tran\systems\paw_bocall\transys\paw\taummed\02582841C-CPP-M01-11.DGN