

EXPANSION JOINT

NOTE: Extra Thickness to be Subsidiary to Price of Square Yards Pavement

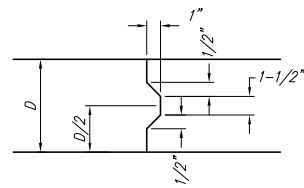

KEYWAY DETAIL

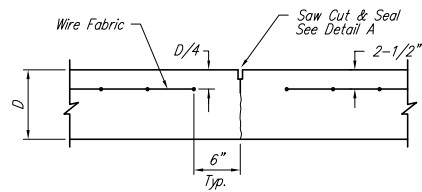

CONTRACTION JOINT DETAIL (C.J.)

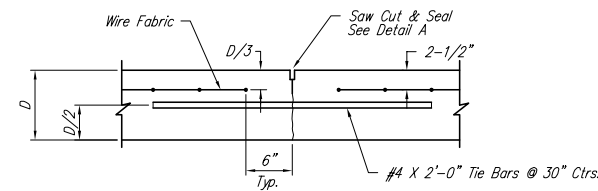

LONGITUDINAL JOINT DETAIL (L.J.)

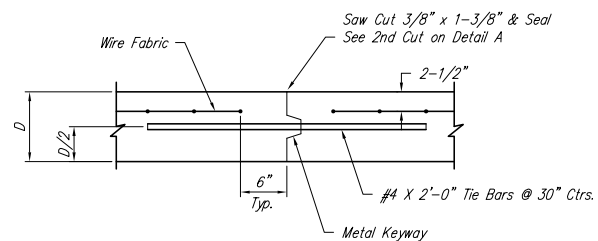

OPTIONAL LONGITUDINAL JOINT DETAIL (L.J.)

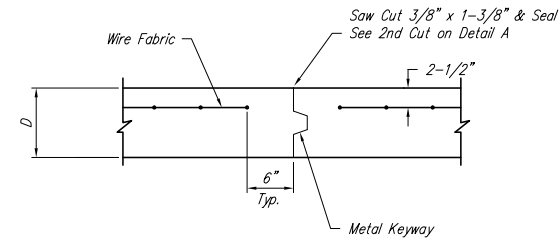

OPTIONAL CONTRACTION JOINT

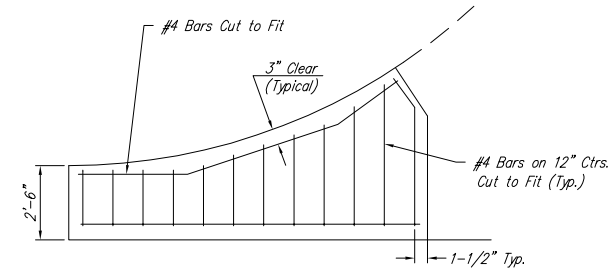

WING REINFORCING DETAIL

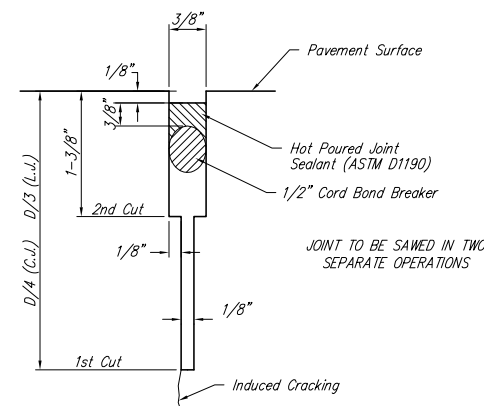

SAW JOINT DETAIL

STANDARD WHEELCHAIR RAMP CONSTRUCTION DETAIL FOR STREETS WITH COMBINED CURB & GUTTER (TYPE A)

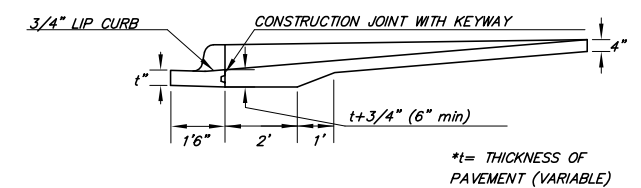
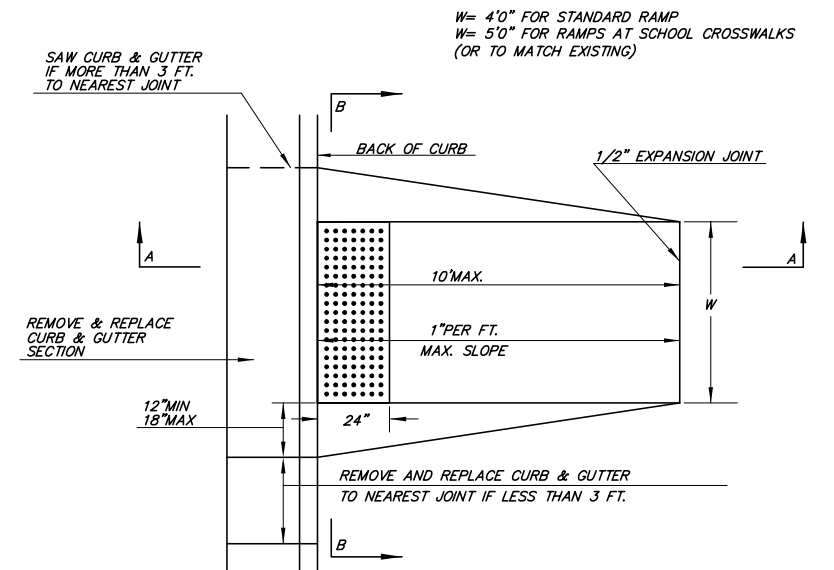

SECTION A-A

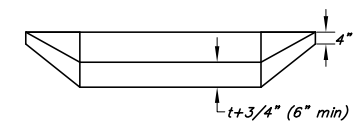

SECTION B-B

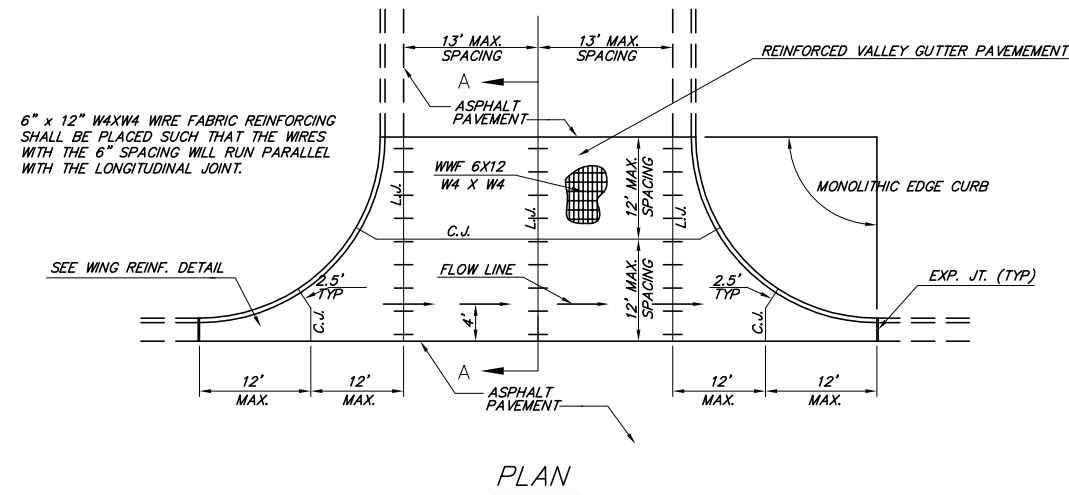

PLAN

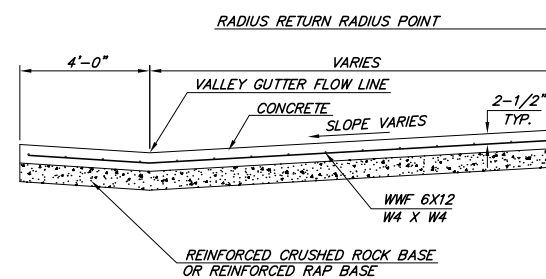

SECTION A-A

REINFORCED VALLEY GUTTER DETAIL

<p>THE CITY OF WICHITA</p> <p>CITY ENGINEER'S OFFICE CITY HALL - SEVENTH FLOOR 455 NORTH MAIN STREET WICHITA, KANSAS 67202 (316) 268-4501 (316) 268-4114 FAX</p>	VALLEY GUTTER DETAILS	
	WHEELCHAIR RAMP DETAILS	
	PROJECT NUMBER 472-84473	OCA # 766137
	DATE MAR 96	SHEET 3 OF 22