

**EXPANSION JOINT**

NOTE: Extra Thickness to be Subsidiary to Price of Square Yards Pavement

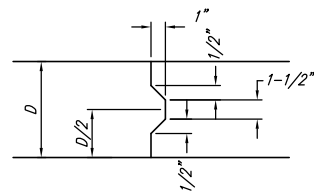

**KEYWAY DETAIL**

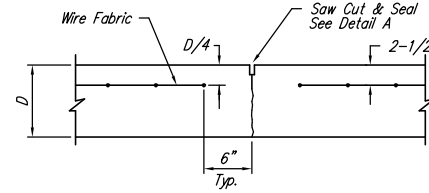

**CONTRACTION JOINT DETAIL (C.J.)**

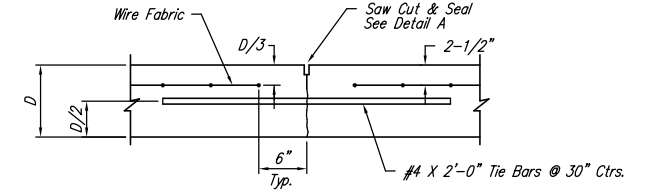

**LONGITUDINAL JOINT DETAIL (L.J.)**

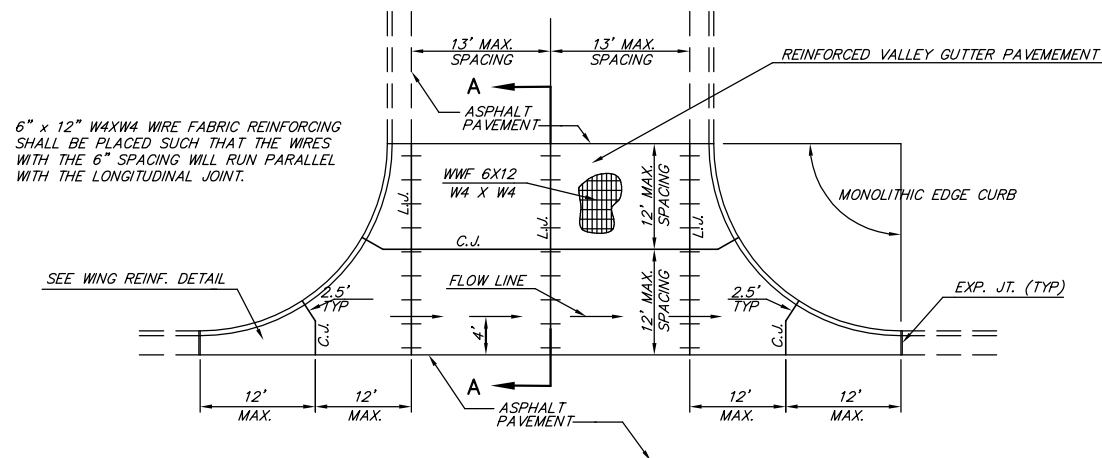

**PLAN**

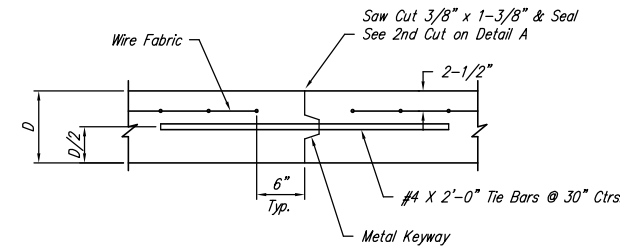

**OPTIONAL LONGITUDINAL JOINT DETAIL (L.J.)**

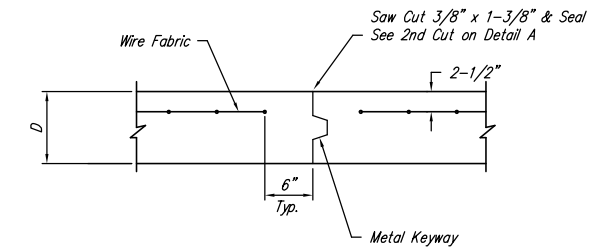

**OPTIONAL CONTRACTION JOINT**

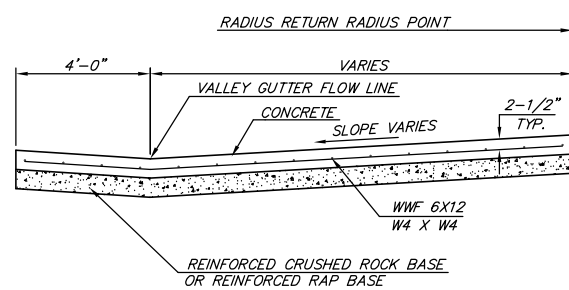

**SECTION A-A**

**REINFORCED VALLEY GUTTER DETAIL**

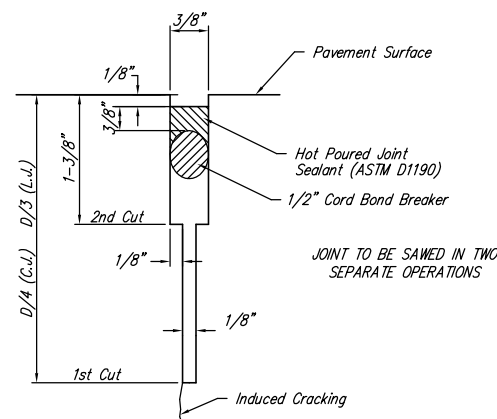

**SAW JOINT DETAIL**

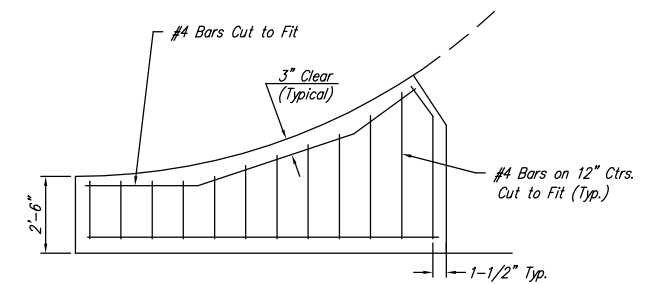

**WING REINFORCING DETAIL**

<p>THE CITY OF WICHITA</p> <p>CITY ENGINEER'S OFFICE CITY HALL - SEVENTH FLOOR 455 NORTH MAIN STREET WICHITA, KANSAS 67202 (316) 268-4501 (316) 268-4114 FAX</p>	<b>VALLEY GUTTER DETAILS</b>	
	JAMES L. ARMOUR, P.E. - CITY ENGINEER	
	PROJECT NUMBER 472-84470	OCA NUMBER 766119
	DATE April 07	<b>Sheet 3 of 25</b>

G:\CIVIL\99118\DWG\PAV\PH\_10\BIND\99118ED1.DWG