

FHWA REGION NO.	STATE	PROJECT NO.	YEAR	SHEET NO.	TOTAL SHEETS
7	KANSAS	87 N 0064-01	1997	59	130

- NOTES:
- 1) Temporary Slope Drain and Temporary Berm may be used on either project foreslopes or project backslopes.
 - 2) Discharge of Slope Drains shall be into stabilized ditch or area, or into Sediment Basin.
 - 3) Pipe shall be secured in place as approved by Engineer.

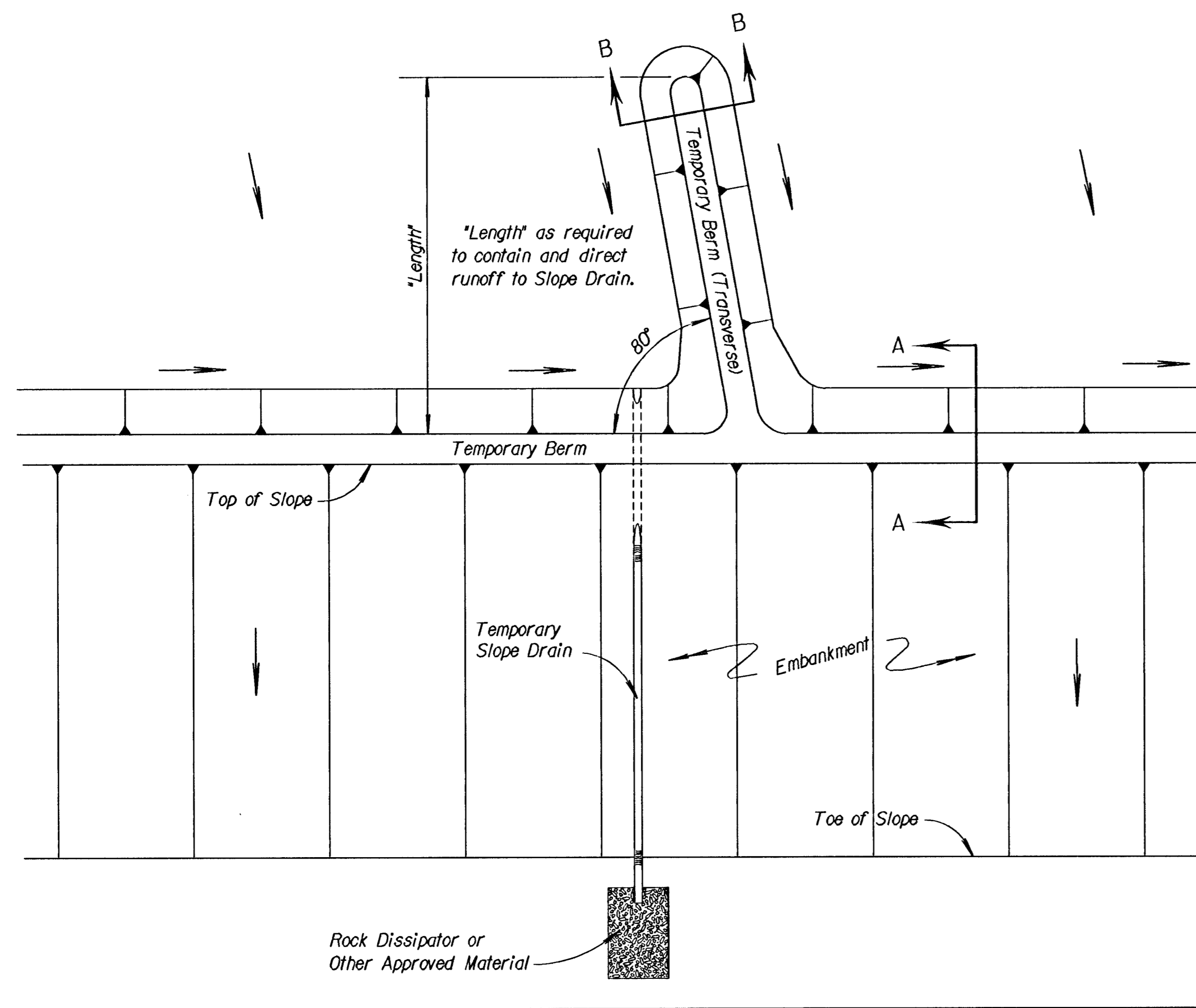

TYPICAL PLAN VIEW OF TEMPORARY BERM AND TEMPORARY SLOPE DRAIN
NO SCALE

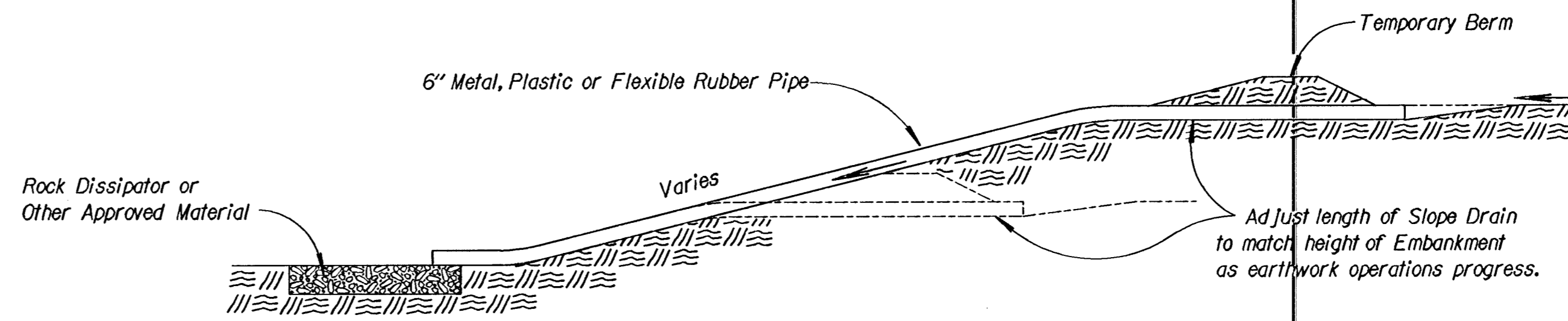

TYPICAL PROFILE OF TEMPORARY SLOPE DRAIN
NO SCALE

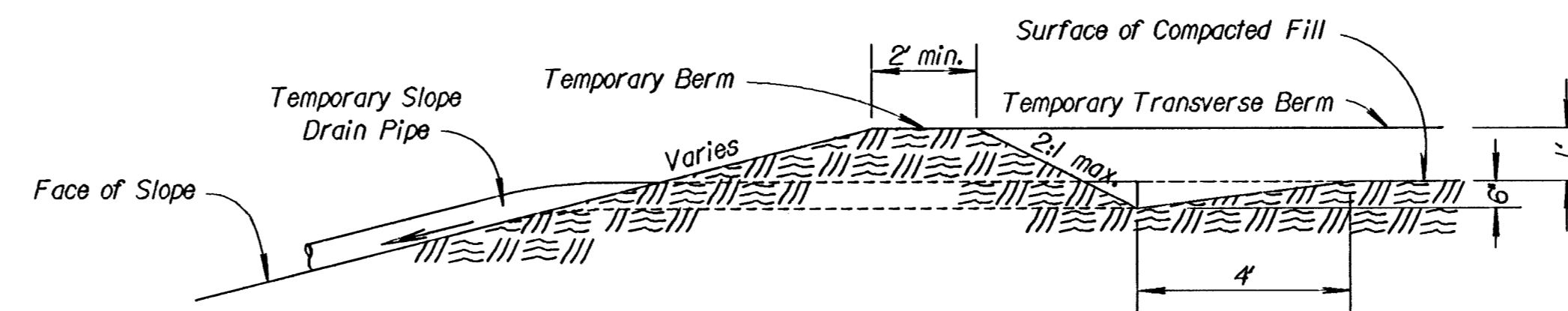

SECTION A-A
NO SCALE

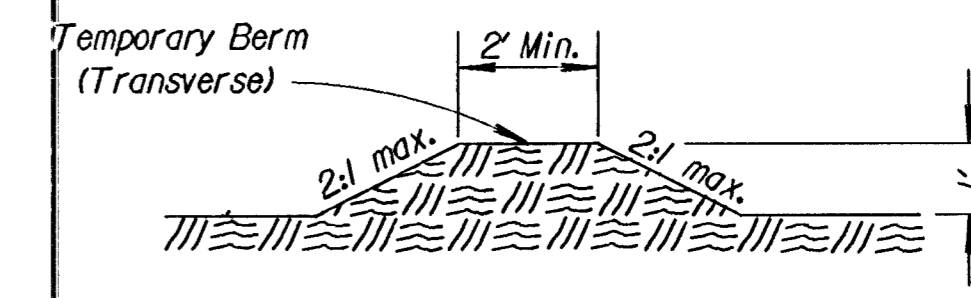

SECTION B-B
NO SCALE

TYPICAL PROFILE OF TEMPORARY BERM
NO SCALE

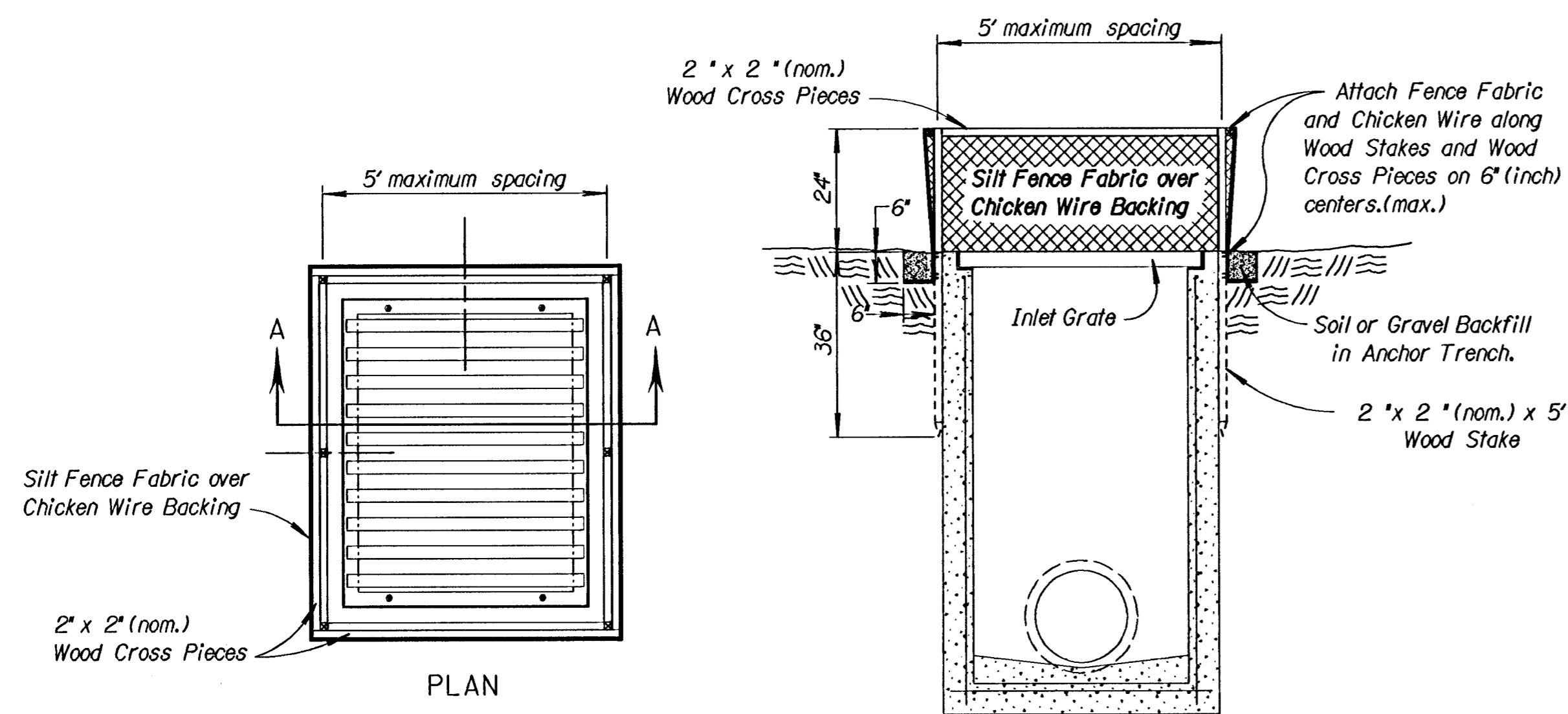

TEMPORARY MEDIAN INLET SEDIMENT BARRIER
NO SCALE

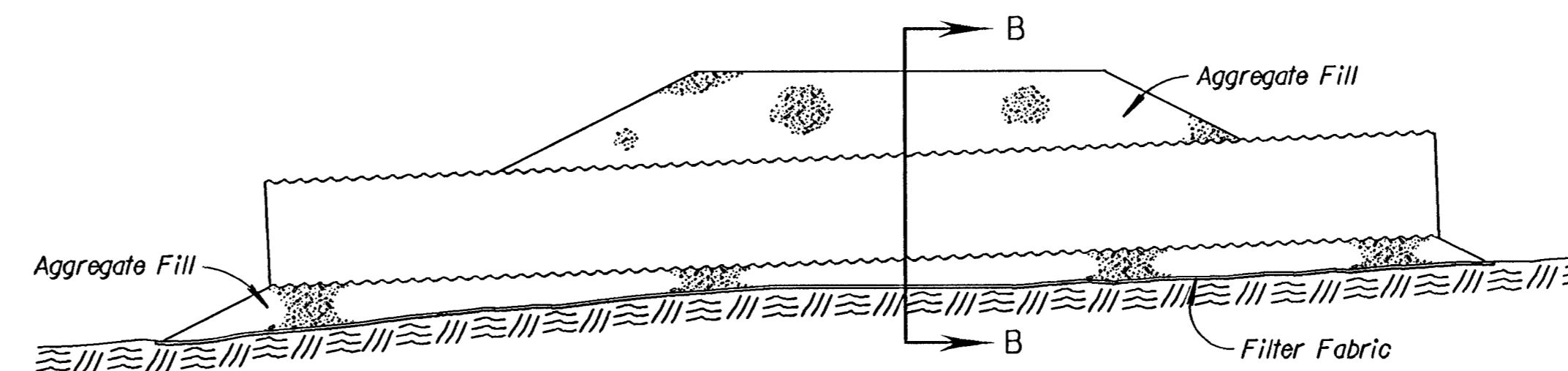

SECTION A-A

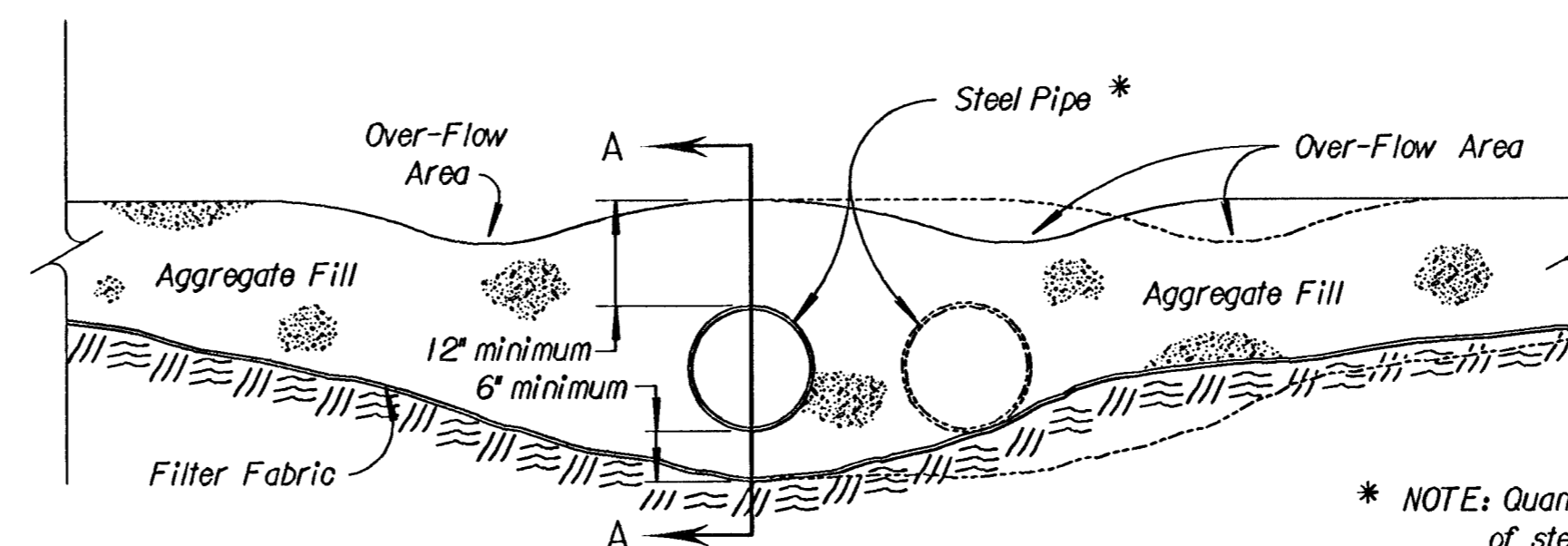

SECTION B-B

TEMPORARY STREAM CROSSING
NO SCALE

* NOTE: Quantity, length and diameter of steel pipe to be determined by design flow calculations.

NO.	DATE	REVISIONS	BY	APP'D
3				
2				
1				

KANSAS DEPARTMENT OF TRANSPORTATION
TEMPORARY PROJECT WATER POLLUTION CONTROL
TEMPORARY SLOPE DRAIN, STREAM CROSSING, MEDIAN INLET SEDIMENT BARRIER
LA852C
F.H.W.A. APPROVAL 5-11-95 APP'D Richard D. Rose
DESIGNED WCL/Detailed DEL QUANTITIES TRACED DEL
DESIGN CK. RDR/Detail CK. WCL/Quan. CK. TRACE CK. WCL

Drawn By: \$\$\$USER/NAME\$\$\$
Dgn File: \$\$\$DGN/SPEC\$\$\$
Plotted: \$\$\$SYTIME\$\$\$ View= PLOT 1