

Hydro Group of Soils (D) As Prepared by USDA-Soil Con. Service Map 4, 1979

Scale: 4" = 1 Mile

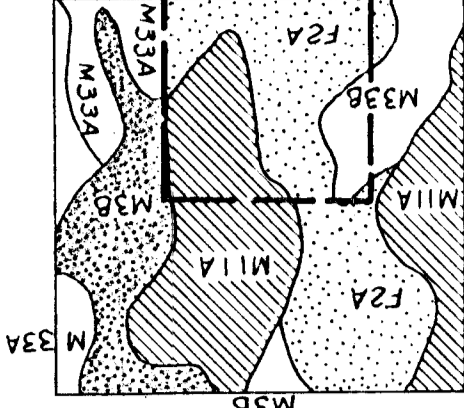

NOTE: Minimum Pad Elevations for Houses Within 3 Feet of Lots from Pond or Drainage Reserve: 145.5'

Cross Section 70' Channel

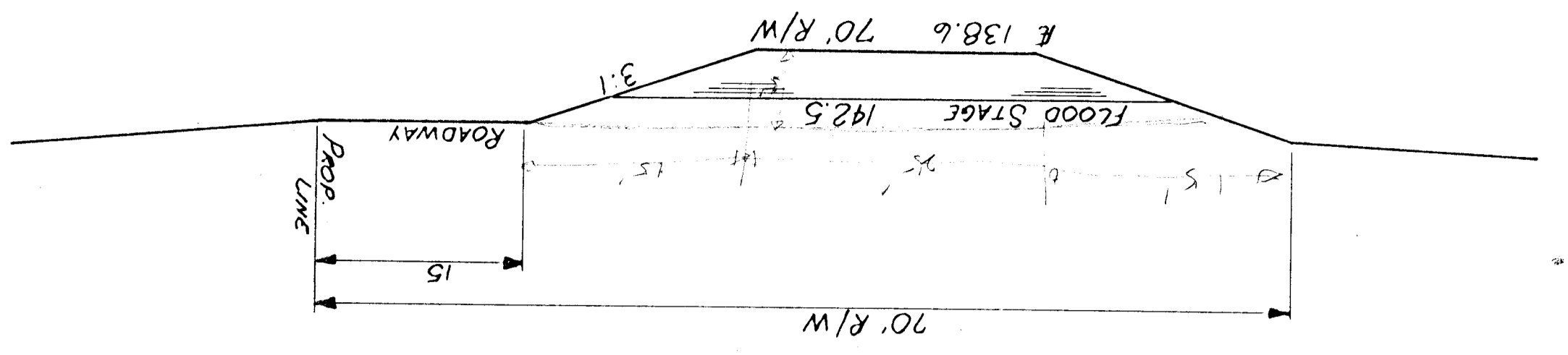

Detail A

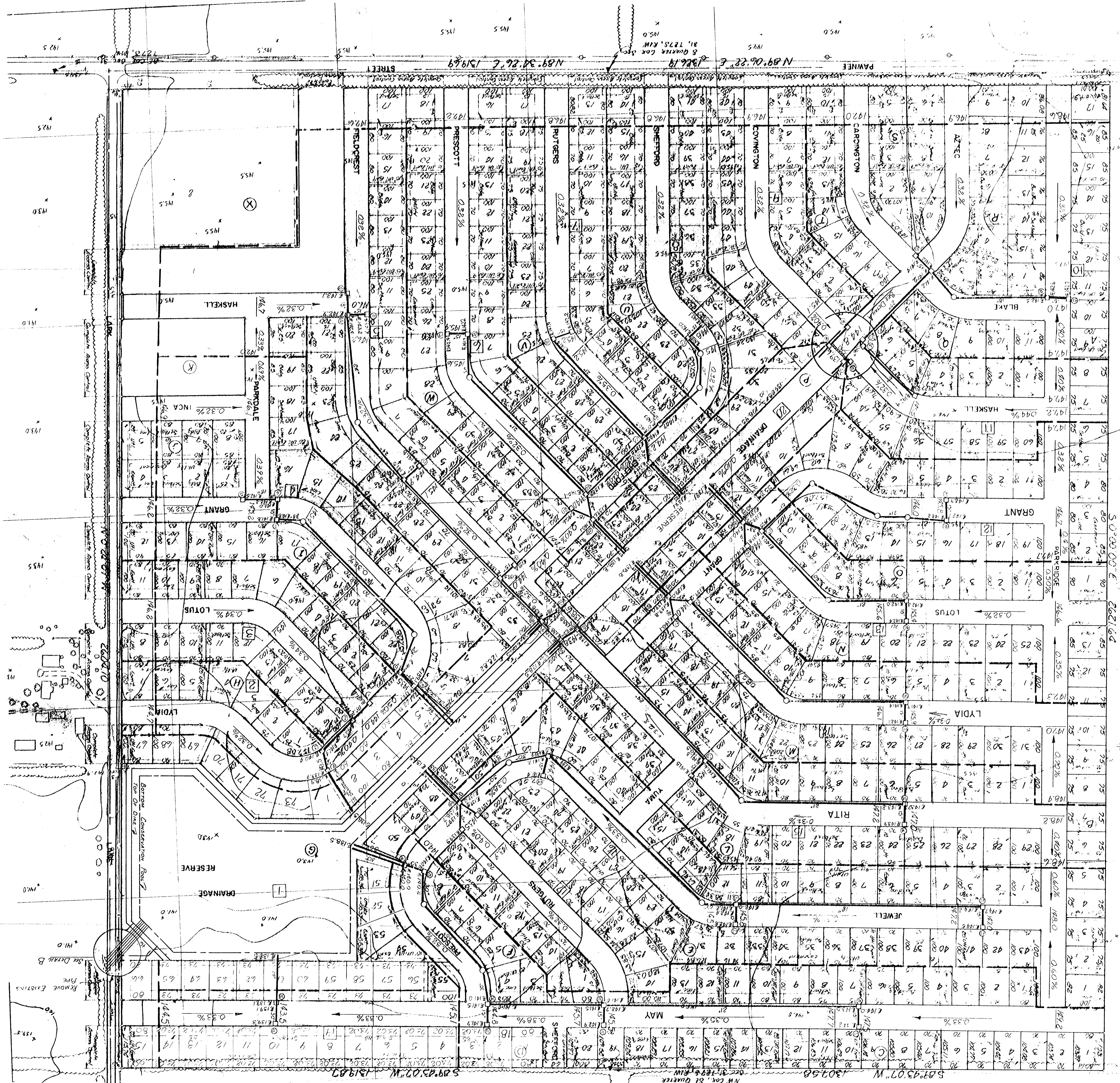
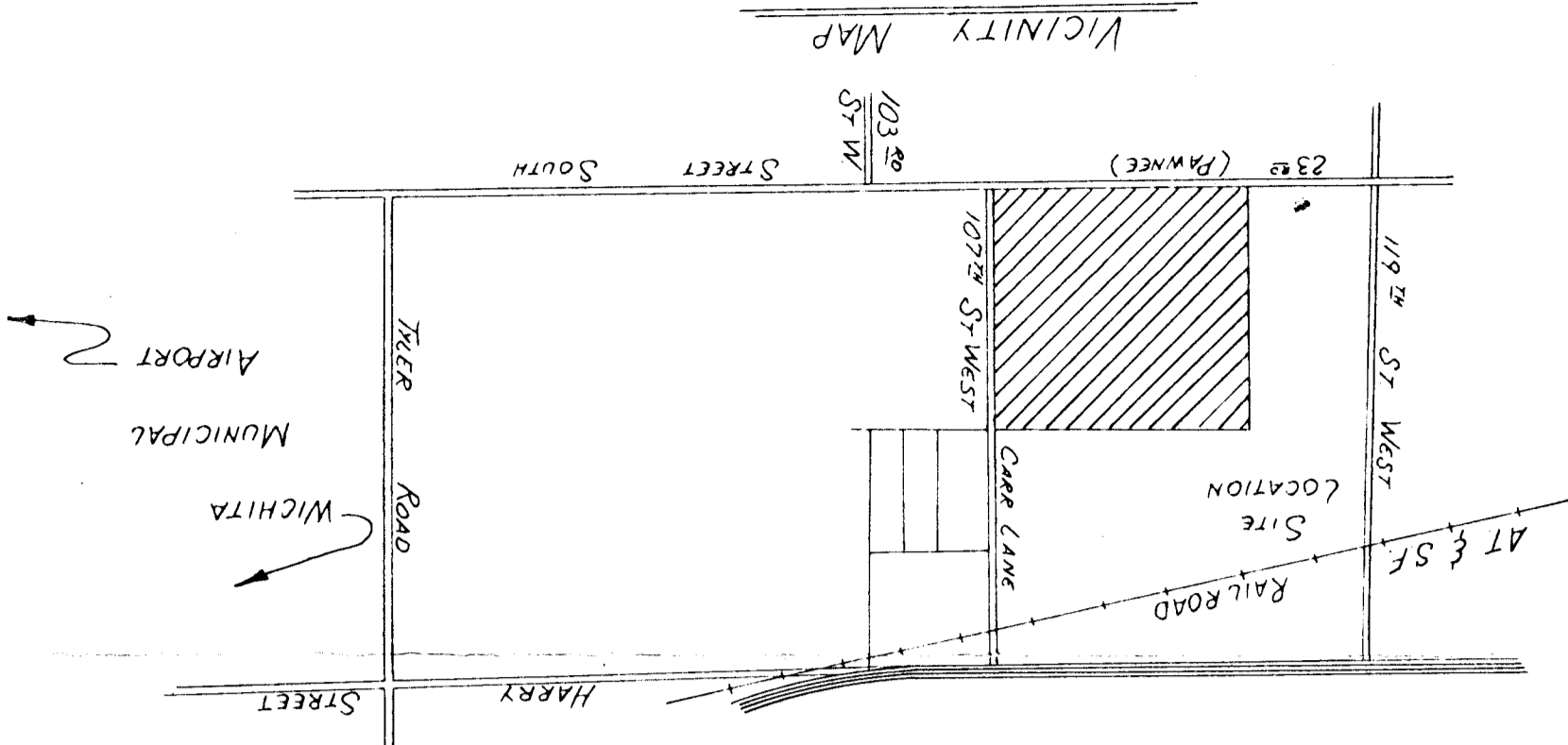
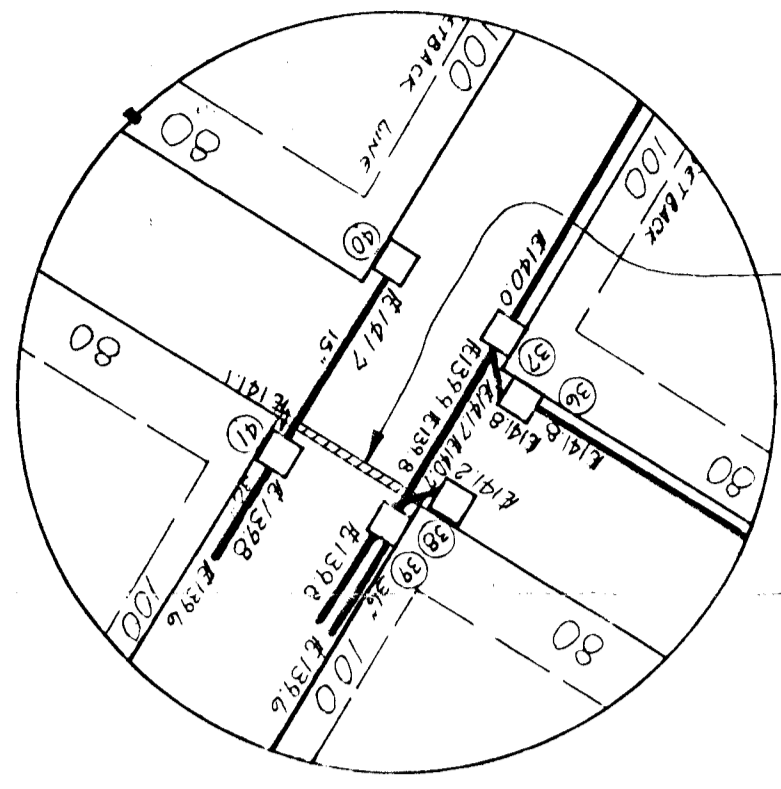

Structure Across Fieldcrest

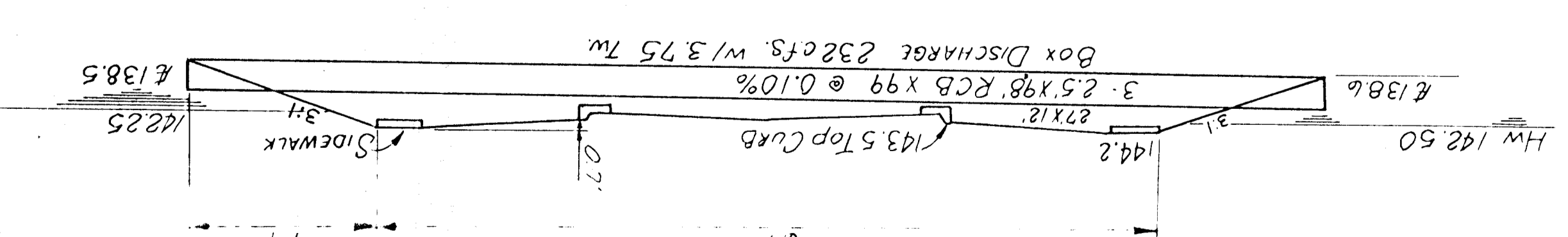

Cross Section Pond Outlet

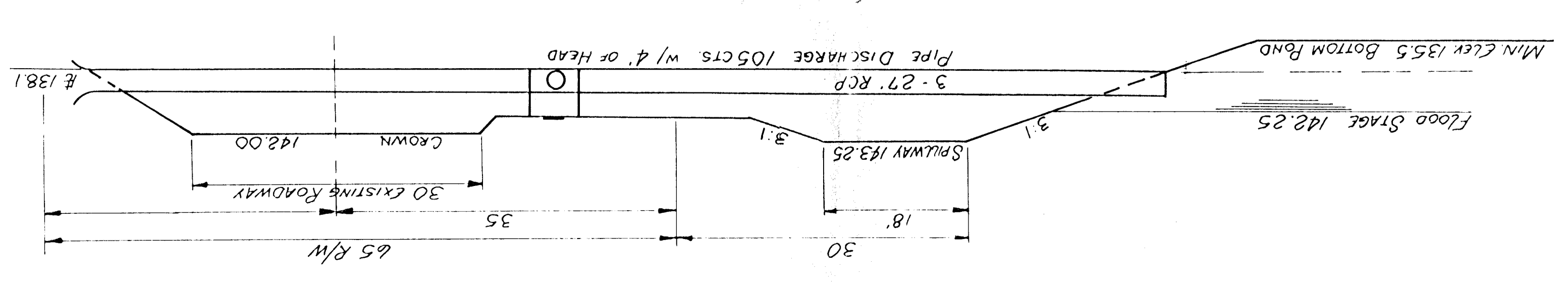

Detail B

