

HIGH EDGE CURB & GUTTER
NOT TO SCALE

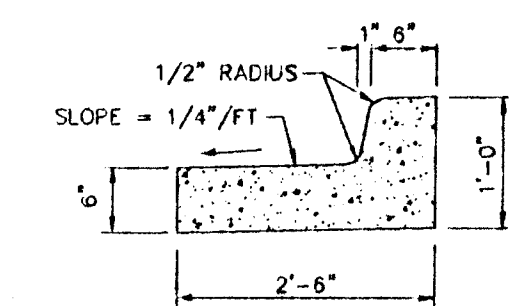

LOW EDGE CURB & GUTTER
NOT TO SCALE

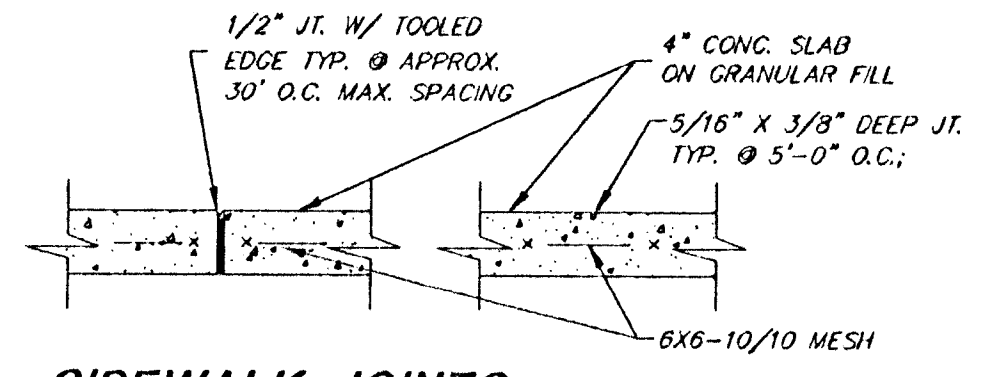

SIDEWALK JOINTS
NOT TO SCALE

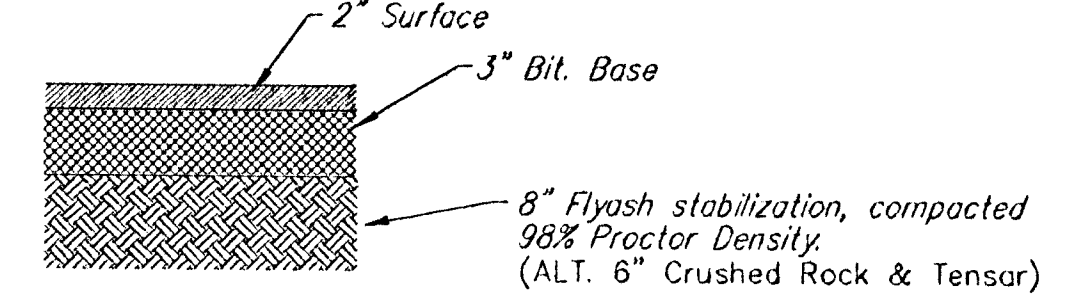

TYP. 5" ASPHALT PAVEMENT DETAIL
NOT TO SCALE FOR THE PARKING LOT AREA

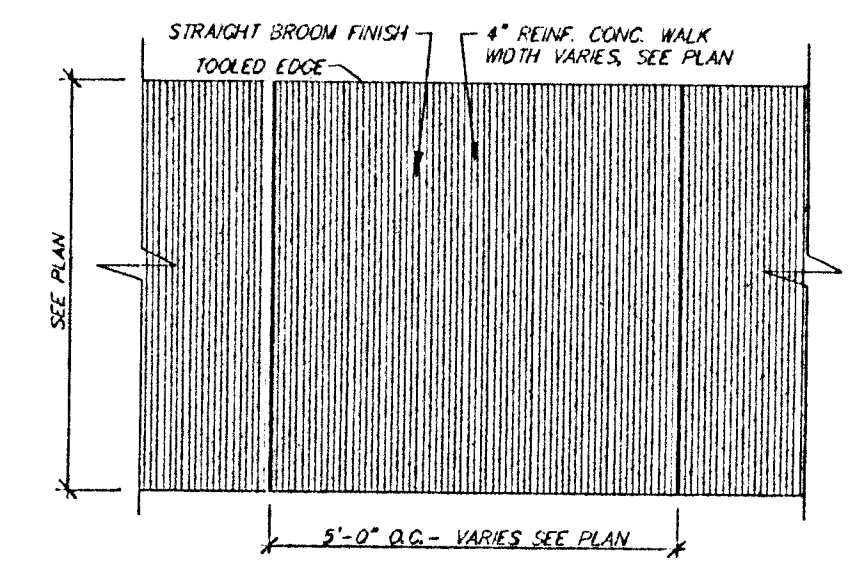

TYP. PATTERN IN WALK
NOT TO SCALE

SCANNED

PRINTS ISSUED		
DATE	PURPOSE	NO.
4/17/02	BIDDING & PERMIT REVIEW	

FOR CONSTRUCTION:		
REVISIONS		
DATE	ITEM	NO.
6.14.02	Review Comments	1

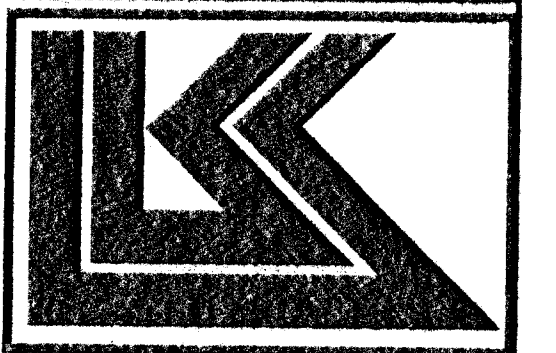

LAW/KINGDON, INC.
ARCHITECTS & ENGINEERS
345 RIVERVIEW WICHITA, KS 67203
Phone (316) 268-3333 Fax (316) 268-0205
www.lawkingdon.com

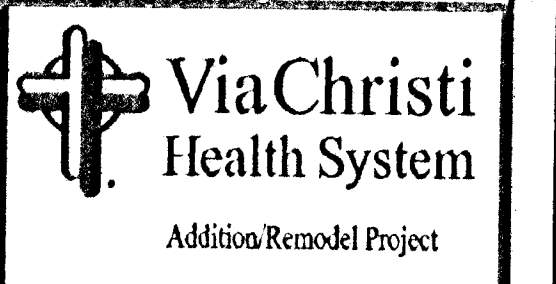

Via Christi Health System
Addition/Remodel Project

DRAWN	CHECKED
5-10-02 by SQH	NBW

RELATED DRAWINGS

SHELL	
DETAILS	
STRUCTURE	
MECHANICAL	
ELECTRICAL	
OTHER	

SEQUENCE NUMBER
OF SHEETS

V.C.H.S. OFFICE ADDITION
3720 E. BAYLEY
WICHITA, KANSAS
PROJECT NUMBER 74470

KEY PLAN

TITLE SHEET	
SHEET TITLE	SHEET NUMBER
G	
OF SHEETS	

LEGAL DISCRPTION:

BLOCK 1, LOT 1, SISTERS OF ST. JOSEPH 2ND ADDITION, AND LOT 1, BLOCK A, SISTERS OF ST. JOSEPH 4TH ADDITION.

GRADING NOTES

- Contractor will be required to provide notice to utility companies a minimum of two (2) WORKING days prior to any excavation, as follows:
Kansas One-Call 687-2470
The Contractor must notify the following in case of an emergency:
Gas Communications(Cablevision) 262-4270
Kansas Gas Service Company 1-800-482-4950
Water Energy(Electric) 383-8650
Aqua Energy (Gas) 1-800-303-0357
Southwestern Bell (Telephone) 268-2245 or 800-268-8313
City of Wichita Water Dept. 268-4583 or 268-4968
City of Wichita Traffic Maint. (Traffic Control) 268-4034 or 268-4203
City of Wichita Sewer Maint. (San. Sewer) 268-4024 or 262-6000
City of Wichita Storm Sewer (Storm Sewer) 268-4690
- Exist. utilities and their locations, as shown on the plans, represent the best information obtainable for design. Location information has been obtained from the various utility companies and is either from company record drawings or company-provided field locations. The Contractor will be required to work around existing utilities which do not conflict with proposed construction. Traffic affected by the construction on this project shall be in accordance with the Kansas Department of Transportation Manual on Uniform Traffic Control Devices.
- The Contractor to verify utility locations prior to construction of this project.
- Striping, striping and restriping shall be installed in accordance w/ City of Wichita Specifications and Codes. Striping shall be painted markings in conformance with the latest edition of the Standard Specifications for State Road and Bridge Construction by the Kansas Department of Transportation.
- Paved lot to be constructed with Asphaltic Concrete Asphalt pavement shall be 5" Subgrade to be compacted to 98% Proctor Density and treated with BX Fly Ash Stabilized. Refer to Pavement details to verify depths.
- Handicap accessible ramps shall be constructed at both drive approach locations. The ramps shall be constructed in accordance with ADA standards and City of Wichita Specifications.

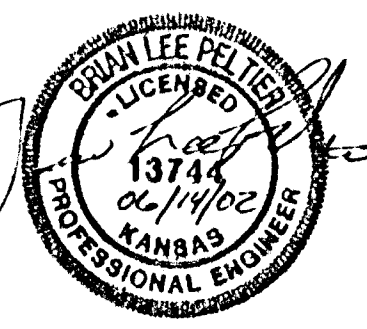

SCANNED

BAUGHMAN COMPANY P.A.
ENGINEERING, SURVEYING & PLANNING
318-282-2271, 318-282-2272, 318-282-2273
P:\Eng\146\ChristNew\stjohnpaw.sch

