

**SECTION - DRY STONE RETAINING WALL / TREE WELL**  
NOT TO SCALE

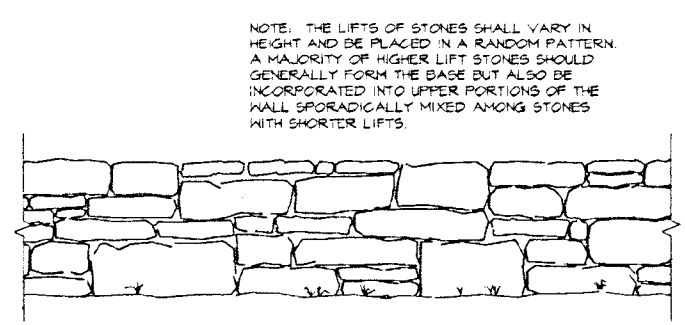

**ELEVATION - TYPICAL DRY STONE WALL / TREE WELL**  
NOT TO SCALE

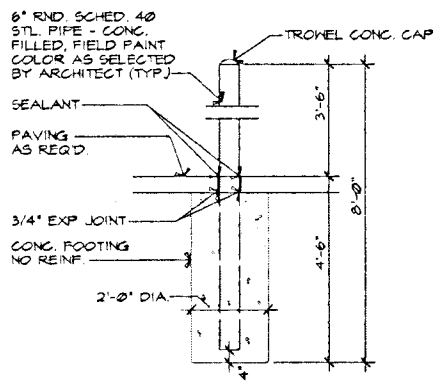

**6\"/> NOT TO SCALE**

NOTE: GATES SHALL BE FABRICATED FROM 1/2\"/>

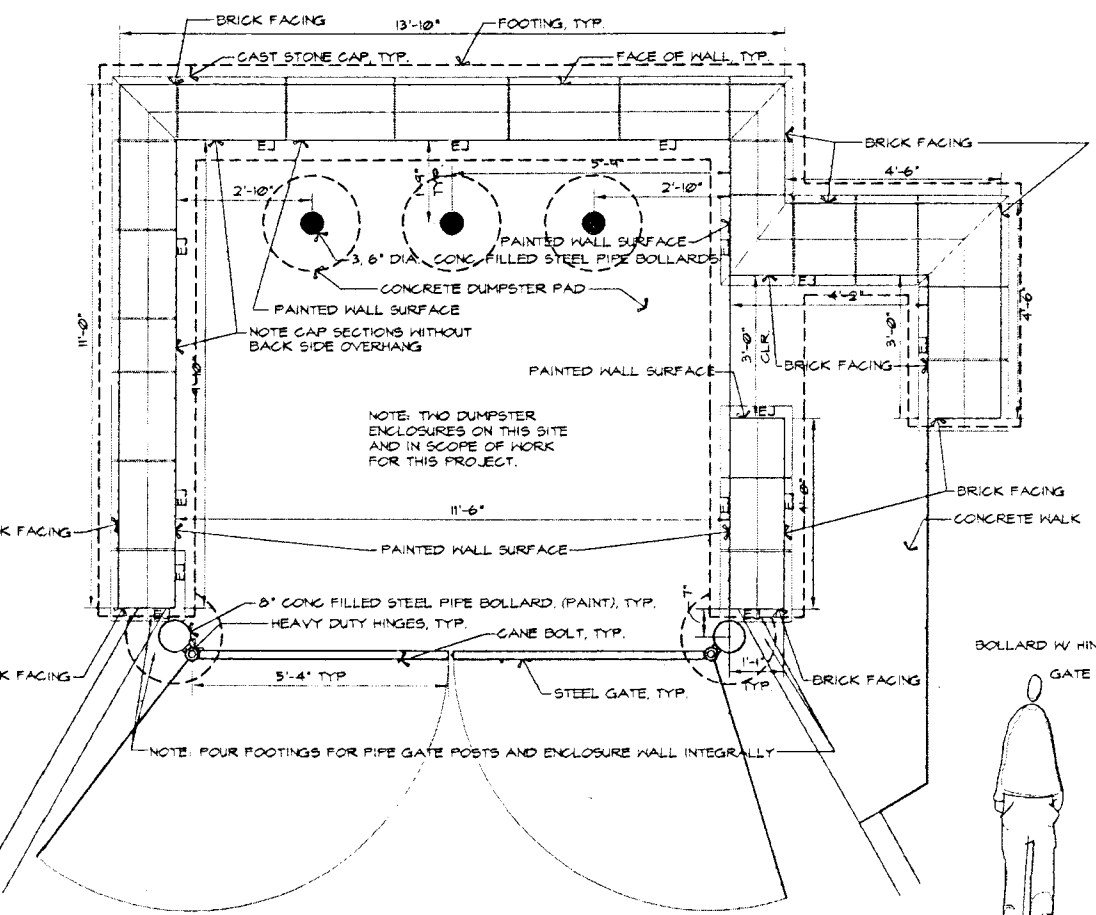

**PLAN - DUMPSTER ENCLOSURE**  
NOT TO SCALE

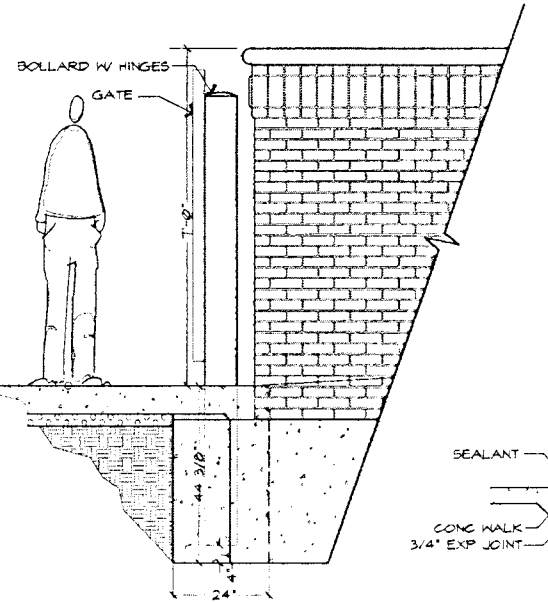

**ELEVATION - DUMPSTER ENCLOSURE**  
NOT TO SCALE

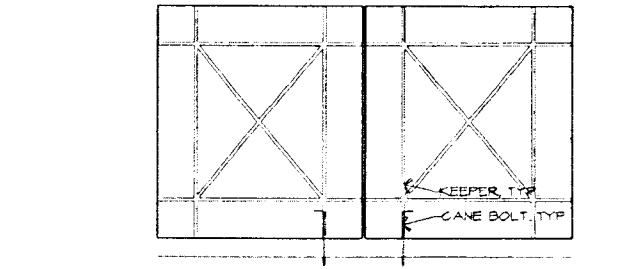

**FRONT ELEVATION - GATES**  
NOT TO SCALE

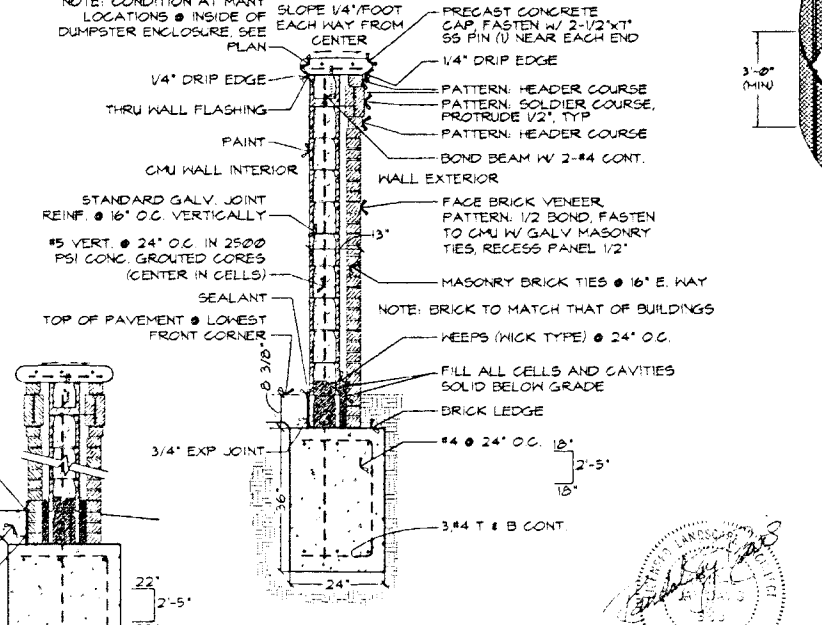

**WALL SECTION**  
NOT TO SCALE

CONCEPT WHERE DOUBLE FACED

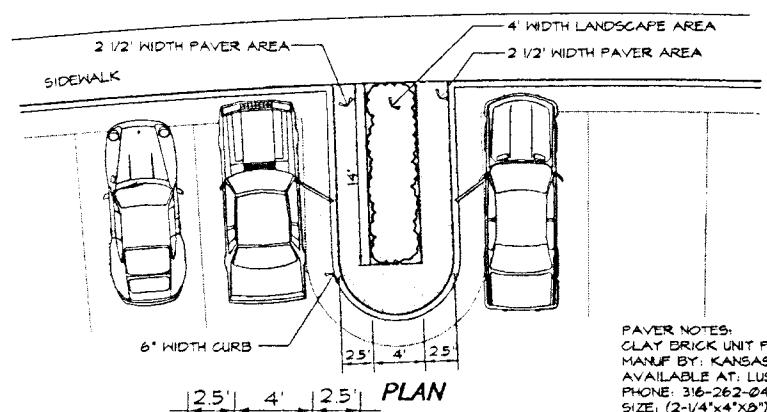

**BRICK PAVER ISLAND WITH LANDSCAPE STRIP**  
NOT TO SCALE

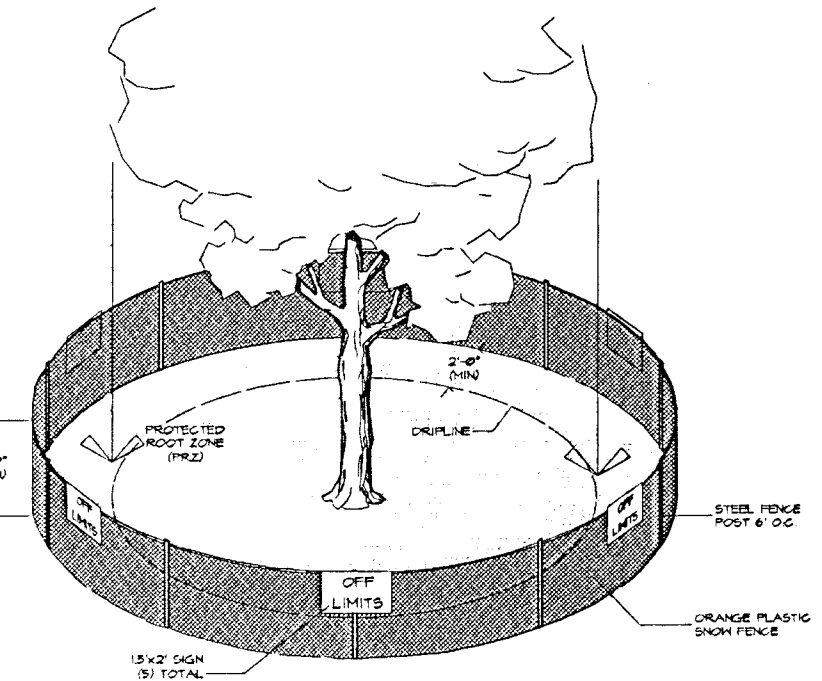

**TEMPORARY TREE PROTECTION**  
NOT TO SCALE

**THE EXECUTIVE AT THE WATERFRONT**  
PROJECT NAME

**MKEC**  
ENGINEERING CONSULTANTS  
111 W. 101st St.  
WICHITA, KS 67208  
316-262-9400

**PAVING DETAILS**  
SHEET TITLE

DESIGN BY: SRS	DRAWN BY: DBG/RJD	CHECKED BY: GJA
DATE: FEBRUARY 2005	JOB NO: 04026	SHEET OF: 5 / 5