

DRAINAGE PLAN
COPPER GATE
ESTATES
TO
WICHITA, SEDGWICK COUNTY, KANSAS

Prepared By



BAUGHMAN COMPANY, P.A.
ENGINEERING, SURVEYING & PLANNING
316/262-7271 FAX 316/262-0149 WICHITA, KANSAS 67211

July 22, 2002

INTRODUCTION

This report provides information and calculations to support the "Drainage Plan" for the property located in the Northeast Quarter of Section 14, T-27-S, R-2-W in Sedgwick County, Kansas.

The "Drainage Plan" being submitted herein is intended to serve as a guide for the design of detention facilities and storm water sewer improvements to the proposed developments. Modifications to structures, pipes, etc. may be necessary during the final design in order to obtain the most economical design and construction possible.

Hydrologic Summary

Return Period years	Existing Conditions Peak Discharge at 135th St. W. cfs	Developed Conditions Peak Discharge at 135th St. W. W/O Detention cfs	Developed Conditions Peak Discharge at 135th St. W. W/O Detention cfs
2	160	200	100
5	260	300	180
100	610	670	460

Existing Conditions Hydrologic Model

Name..... Watershed
 File..... C:\HAESTAD\PPKW\PROJECTS\COPPERGATE\EXISTING.PPW

MASTER DESIGN STORM SUMMARY

Default Network Design Storm File, ID WICHITA.RNQ COW25100

Return Event	Total Depth in	Rainfall Type	RNF File	RNF ID
Pre..2	3.6000	Synthetic Curve	SCSTYPES	TypeII 24hr
Pre..5	4.5600	Synthetic Curve	SCSTYPES	TypeII 24hr
Pre100	7.6800	Synthetic Curve	SCSTYPES	TypeII 24hr

MASTER NETWORK SUMMARY
 SCS Unit Hydrograph Method

(*Node=Outfall; +Node=Diversion;)
 (Trun= HYG Truncation: Blank=None; L=Left; R=Rt; LR=Left&Rt)

Storage Node ID	Return Type Event	HYG Vol ac-ft	Trun hrs	Qpeak cfs	Max WSEL ft	Pond ac-ft
*135TH ST.	JCT 2	31.644	12.7000	163.33		
*135TH ST.	JCT 5	48.783	12.7000	260.20		
*135TH ST.	JCT 100	112.147	12.6500	612.69		
BASIN	AREA 2	31.644	12.7000	163.33		
BASIN	AREA 5	48.783	12.7000	260.20		
BASIN	AREA 100	112.147	12.6500	612.69		

**Developed Conditions
Without Detention
Hydrologic Model**

MASTER DESIGN STORM SUMMARY

Default Network Design Storm File, ID WICHITA.RN0 COW25100

Return Event	Total		Rainfall		RNF File	RNF ID
	Depth	in	Type			
Dev..2	3.6000		Synthetic Curve	SCSTYPES	TypeII	24hr
Dev..5	4.5600		Synthetic Curve	SCSTYPES	TypeII	24hr
Dev100	7.6800		Synthetic Curve	SCSTYPES	TypeII	24hr

MASTER NETWORK SUMMARY
 SCS Unit Hydrograph Method

(*Node=Outfall; +Node=Diverstion;)
 (Trun= HYG Truncation: Blank=None; L=Left; R=Rt; LR=Left&Rt)

Storage Node ID	Return Type Event	HYG Vol ac-ft	Trun	Qpeak hrs	Qpeak CFS	Max WSEL ft	Max Pond ac-ft
*135TH	JCT 2	33.500		12.1000	199.56		
*135TH	JCT 5	50.793		12.1000	303.32		
*135TH	JCT 100	114.069		12.1000	672.42		
MAJORBASIN	AREA 2	20.789		12.6000	114.64		
MAJORBASIN	AREA 5	32.350		12.6000	185.54		
MAJORBASIN	AREA 100	75.455		12.6000	445.12		
NODE	JCT 2	33.500		12.1000	199.56		
NODE	JCT 5	50.793		12.1000	303.32		
NODE	JCT 100	114.069		12.1000	672.42		
OFFSITE SOUTH	AREA 2	1.091		12.2000	10.73		
OFFSITE SOUTH	AREA 5	1.682		12.2000	17.00		
OFFSITE SOUTH	AREA 100	3.867		12.2000	39.59		
ONSITE DS	AREA 2	6.067		12.0500	88.07		
ONSITE DS	AREA 5	8.612		12.0500	124.07		
ONSITE DS	AREA 100	17.366		12.0500	242.79		
ONSITEUS	AREA 2	3.371		12.0500	48.93		
ONSITEUS	AREA 5	4.785		12.0500	68.93		
ONSITEUS	AREA 100	9.648		12.0500	134.88		

Name..... Watershed
 File..... C:\HAESTAD\PPKM\PROJECTS\COPPERGATE2\COPPER2.PPW

MASTER NETWORK SUMMARY
 SCS Unit Hydrograph Method

(*Node=Outfall; +Node=Diversion;)
 (Trun= HYG Truncation: Blank=None; L=Left; R=Rt; LR=Left&Rt)

Storage Node ID	Type	Event	Return	HYG Vol	ac-ft	Trun	Qpeak	hrs	Qpeak	cfs	Max WSEL	Pond	Max ac-ft
POND	IN	POND	2	32.409			12.1000		190.23				
POND	IN	POND	5	49.111			12.1000		288.17				
POND	IN	POND	100	110.202			12.1000		636.00				
POND	OUT	POND	2	32.409			12.1000		190.23				
POND	OUT	POND	5	49.111			12.1000		288.17				
POND	OUT	POND	100	110.202			12.1000		636.00				
RCBC	IN	POND	2	26.342			12.5000		131.11				
RCBC	IN	POND	5	40.499			12.5000		210.95				
RCBC	IN	POND	100	92.837			12.4500		504.65				
RCBC	OUT	POND	2	26.342			12.5000		131.11				
RCBC	OUT	POND	5	40.499			12.5000		210.95				
RCBC	OUT	POND	100	92.837			12.4500		504.65				
UPSTREAM	JCT	JCT	2	24.159			12.6000		121.27				
UPSTREAM	JCT	JCT	5	37.134			12.6000		194.56				
UPSTREAM	JCT	JCT	100	85.103			12.5000		463.71				
WEST OFFSITE	AREA	AREA	2	2.182			12.2000		21.47				
WEST OFFSITE	AREA	AREA	5	3.364			12.2000		34.01				
WEST OFFSITE	AREA	AREA	100	7.734			12.2000		79.17				

**Developed Conditions
With Detention
Hydrologic Model**

Type..... Master Network Summary
 Name..... Watershed
 File..... C:\HAESTAD\PPKM\PROJECTS\COPPERGATE2\COPPER2.PPW

MASTER DESIGN STORM SUMMARY

Default Network Design Storm File, ID WICHITA.RNQ COW25100

Return Event	Total Depth in	Rainfall Type	RNF File	RNF ID
A....2	3.6000	Synthetic Curve	SCSTYPES	TypeII 24hr
A....5	4.5600	Synthetic Curve	SCSTYPES	TypeII 24hr
A..100	7.6800	Synthetic Curve	SCSTYPES	TypeII 24hr

ICPM CALCULATION TOLERANCES

Target Convergence= .000 cfs +/-
 Max. Iterations = 35 loops
 ICPM Time Step = .0500 hrs
 Output Time Step = .0500 hrs
 ICPM Ending Time = 35.0000 hrs

MASTER NETWORK SUMMARY
 SCS Unit Hydrograph Method

(*Node=Outfall; +Node=Diversiion;)
 (Trun= HYG Truncation: Blank=None; L=Left; R=Rt; LR=Left&Rt)

Storage Node ID	Return Type Event	HYG Vol ac-ft	Trun	Qpeak hrs	Qpeak cfs	Max WSEL ft	Pond ac-ft	Max ac-ft
*135TH	JCT	33.498		13.1000	104.19			
*135TH	JCT	50.791		13.0000	176.32			
*135TH	JCT	114.065		12.8500	458.10			
MAJORBASIN	AREA	20.789		12.6000	114.64			
MAJORBASIN	AREA	32.350		12.6000	185.54			
MAJORBASIN	AREA	75.455		12.6000	445.12			
NODE	JCT	33.498		13.1000	104.19			
NODE	JCT	50.791		13.0000	176.32			
NODE	JCT	114.065		12.8500	458.10			
OFFSITE SOUTH	AREA	1.091		12.2000	10.73			
OFFSITE SOUTH	AREA	1.682		12.2000	17.00			
OFFSITE SOUTH	AREA	3.867		12.2000	39.59			

Name..... Watershed
 File..... C:\HAESTAD\PPKW\PROJECTS\COPPERGATE2\COPPER2.PPW

MASTER NETWORK SUMMARY
 SCS Unit Hydrograph Method

(*Node=Outfall; +Node=Diverstion;)
 (Trun= HYG Truncation; Blank=None; L=Left; R=Rt; LR=Left&Rt)

Storage Node ID	Type Event	Return HYG Vol ac-ft	Trun	Qpeak hrs	Qpeak cfs	Max WSEL ft	Pond ac-ft	Max
ONSITE DS	AREA	6.067		12.0500	88.07			
ONSITE DS	AREA	8.612		12.0500	124.07			
ONSITE DS	AREA	17.366		12.0500	242.79			
ONSITEUS	AREA	3.371		12.0500	48.93			
ONSITEUS	AREA	4.785		12.0500	68.93			
ONSITEUS	AREA	9.648		12.0500	134.88			
POND	POND	32.410		12.1000	152.53			
POND	POND	49.112		12.1000	237.77			
POND	POND	110.202		12.1000	543.53			
POND	OUT POND	32.407		13.1000	102.31	160.13	7.383	
POND	OUT POND	49.108		13.0000	173.19	160.81	10.505	
POND	OUT POND	110.198		12.9000	449.77	162.88	19.888	
RCBC	POND	26.342		12.5000	131.11			
RCBC	POND	40.499		12.5000	210.95			
RCBC	POND	92.837		12.4500	504.65			
RCBC	OUT POND	26.343		12.6500	128.15	161.70	1.171	
RCBC	OUT POND	40.500		12.6000	206.51	162.53	1.614	
RCBC	OUT POND	92.837		12.5500	494.30	164.96	2.910	
UPSTREAM	JCT	24.159		12.6000	121.27			
UPSTREAM	JCT	37.134		12.6000	194.56			
UPSTREAM	JCT	85.103		12.5000	463.71			
WEST OFFSITE	AREA	2.182		12.2000	21.47			
WEST OFFSITE	AREA	3.364		12.2000	34.01			
WEST OFFSITE	AREA	7.734		12.2000	79.17			

Stormwater Sewer Analysis
Developed Conditions

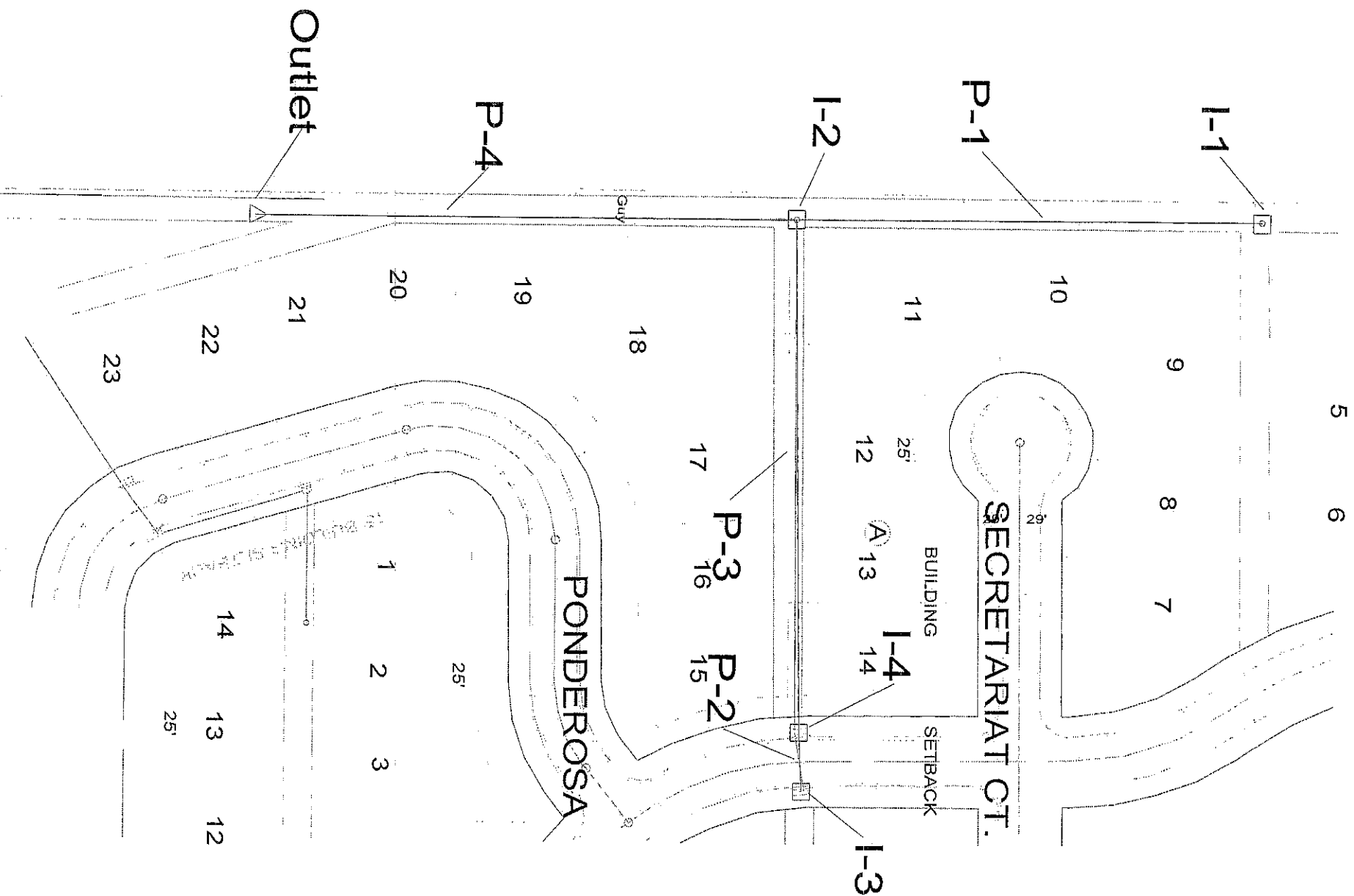

System Report

Pipe	Additional Flow (cfs)	Total Upstream Added (cfs)	Structure Discharge (cfs)	-Node- Upstream Downstream	-Section- Shape Size	Upstream Invert Elevation (ft)	Downstream Invert Elevation (ft)	-Ground- Upstream Downstream (ft)	-HGL- Upstream Downstream (ft)	-Slope- Energy Constructed (ft/ft)	-Section- Discharge Capacity (cfs)	Length (ft)	Average Velocity (ft/s)	Description
P-2	4.50	0.00	4.50	I-3	Circular	170.50	170.00	174.40	171.31	0.007716	4.50	41.00	3.80	
P-3	5.80	4.50	10.30	I-4	18 inch	169.80	167.50	174.40	171.19	0.012195	11.60	359.00	5.43	
				I-2	24 inch			171.20	168.68	0.006407	18.11			
P-1	3.80	0.00	3.80	I-1	Circular	170.00	167.50	173.50	170.75	0.007057	3.80	320.00	3.44	
P-4	2.90	14.10	17.00	I-2	18 inch	167.00	165.00	171.20	168.68	0.007813	9.28	372.00	6.04	
				I-2 Outlet	30 inch			171.20	168.39	0.005376	17.00			30.07

Outlet: Outlet
 Rim: 169.00 ft
 Sump: 165.00 ft

Inlet: I-2
 Rim: 171.20 ft
 Sump: 167.00 ft

Inlet: I-1
 Rim: 173.50 ft
 Sump: 170.00 ft

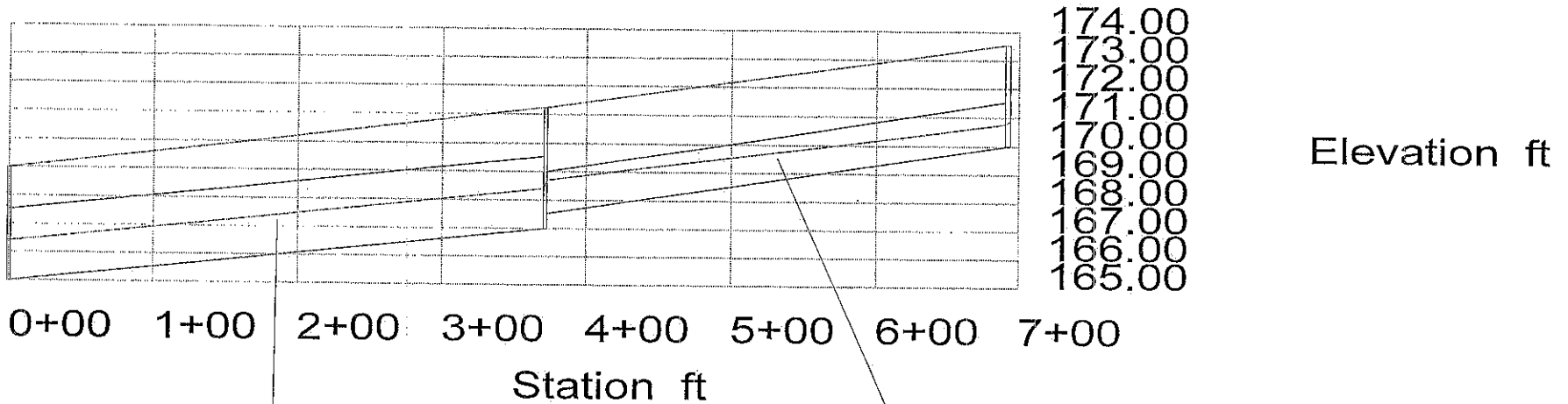

Pipe: P-4
 Up Invert: 167.00 ft
 Dn Invert: 165.00 ft
 Length: 372.00 ft
 Size: 30 inch

Pipe: P-1
 Up Invert: 170.00 ft
 Dn Invert: 167.50 ft
 Length: 320.00 ft
 Size: 18 inch

Inlet: I-3
 Rim: 174.40 ft
 Sump: 170.50 ft

Inlet: I-2
 Rim: 171.20 ft
 Sump: 167.00 ft

Inlet: I-4
 Rim: 174.40 ft
 Sump: 169.80 ft

Outlet: Outlet
 Rim: 169.00 ft
 Sump: 165.00 ft

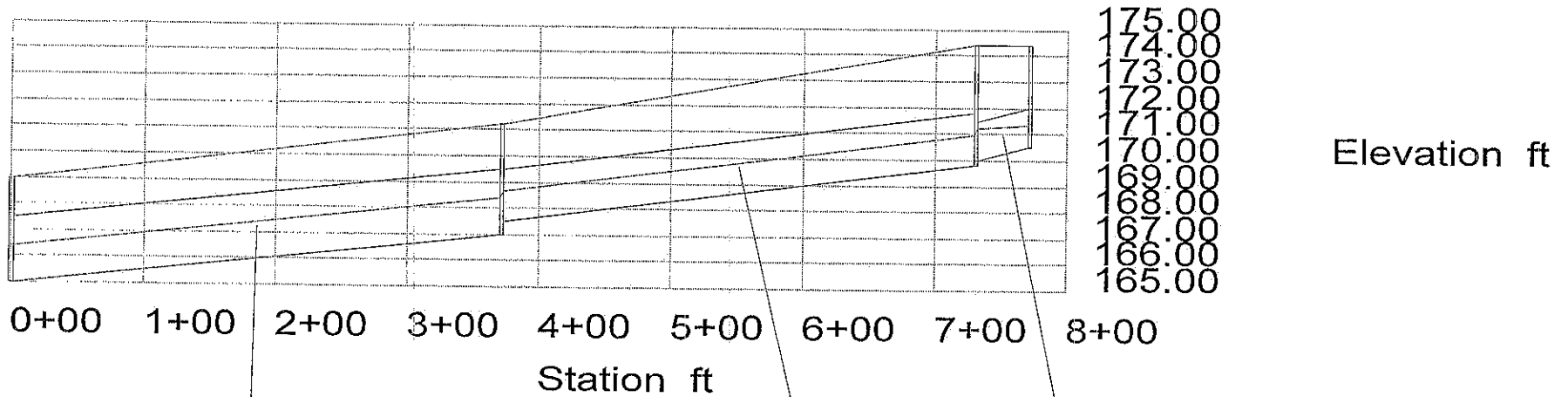

Pipe: P-4
 Up Invert: 167.00 ft
 Dn Invert: 165.00 ft
 Length: 372.00 ft
 Size: 30 inch

Pipe: P-3
 Up Invert: 169.80 ft
 Dn Invert: 167.50 ft
 Length: 359.00 ft
 Size: 24 inch

Pipe: P-2
 Up Invert: 170.50 ft
 Dn Invert: 170.00 ft
 Length: 41.00 ft
 Size: 18 inch

System Report

Pipe	Additional Flow (cfs)	Total Upstream Added (cfs)	Structure Discharge (cfs)	-Node- Upstream Downstream	-Section- Shape Size	Upstream Invert Elevation (ft)	Downstream Invert Elevation (ft)	-Ground- Upstream Downstream (ft)	-HGL- Upstream Downstream (ft)	-Slope- Energy Constructed (ft/ft)	-Section- Discharge Capacity (cfs)	Length (ft)	Average Velocity (ft/s)	Description
P-2	9.90	0.00	9.90	I-3	Circular	170.50	170.00	174.40	174.76	0.008883	9.90	41.00	5.60	
P-3	12.80	9.90	22.70	I-4	Circular	169.80	167.50	174.40	174.40	0.012195	11.60	359.00	7.23	
				I-2	24 inch			171.20	170.81	0.006407	18.11			
P-1	8.40	0.00	8.40	I-1	Circular	170.00	167.50	173.50	172.86	0.006395	8.40	320.00	4.75	
P-4	6.40	31.10	37.50	I-2	Circular	167.00	165.00	171.20	170.81	0.007813	9.28	372.00	8.13	
				Outlet	30 inch			169.00	167.07	0.005376	30.07			

Outlet: Outlet
 Rim: 169.00 ft
 Sump: 165.00 ft

Inlet: I-2
 Rim: 171.20 ft
 Sump: 167.00 ft

Inlet: I-1
 Rim: 173.50 ft
 Sump: 170.00 ft

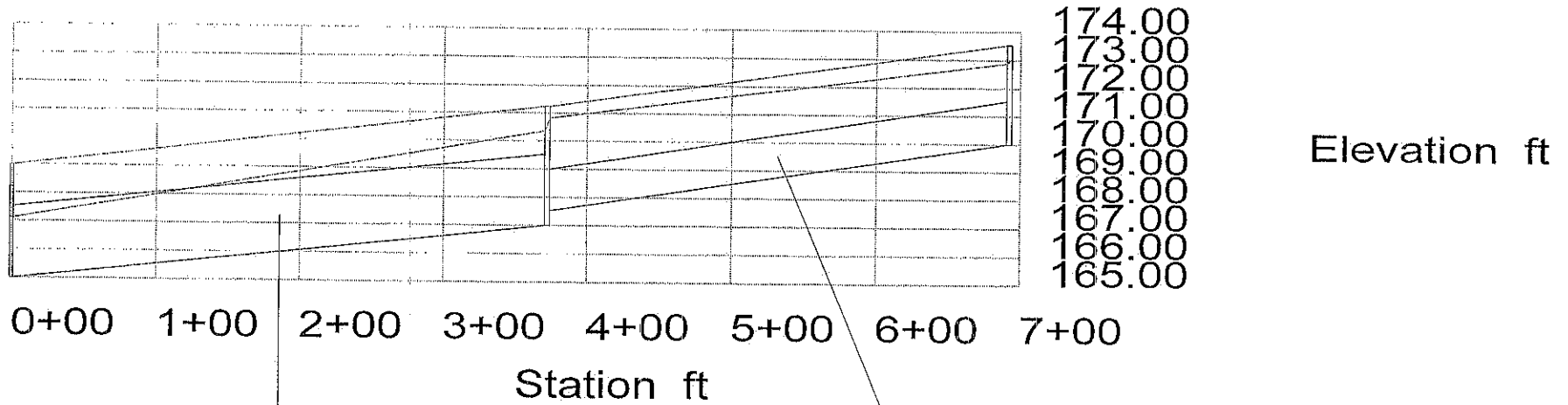

Pipe: P-4
 Up Invert: 167.00 ft
 Dn Invert: 165.00 ft
 Length: 372.00 ft
 Size: 30 inch

Pipe: P-1
 Up Invert: 170.00 ft
 Dn Invert: 167.50 ft
 Length: 320.00 ft
 Size: 18 inch

Outlet: Outlet
Rim: 169.00 ft
Sump: 165.00 ft

Inlet: I-2
Rim: 171.20 ft
Sump: 167.00 ft

Inlet: I-4
Rim: 174.40 ft
Sump: 169.80 ft

Inlet: I-3
Rim: 174.40 ft
Sump: 170.50 ft

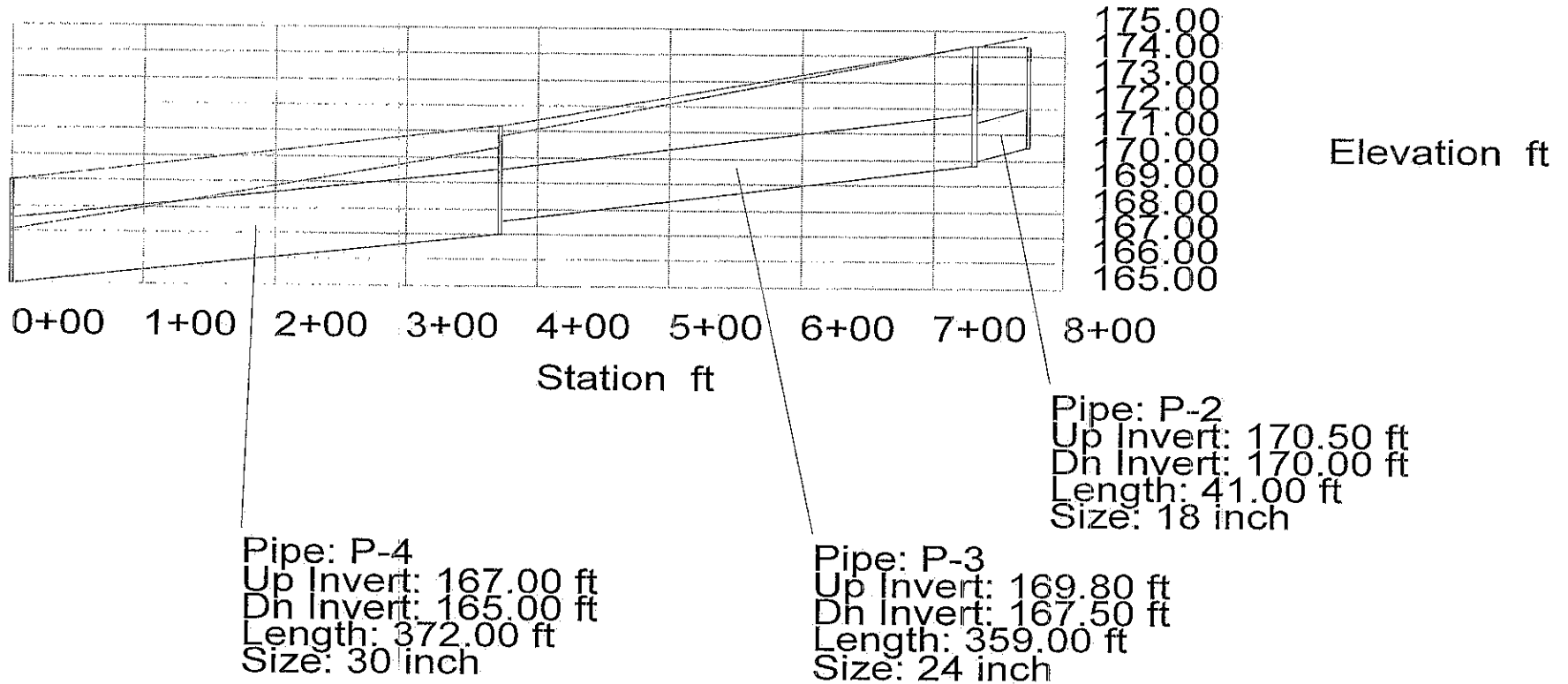

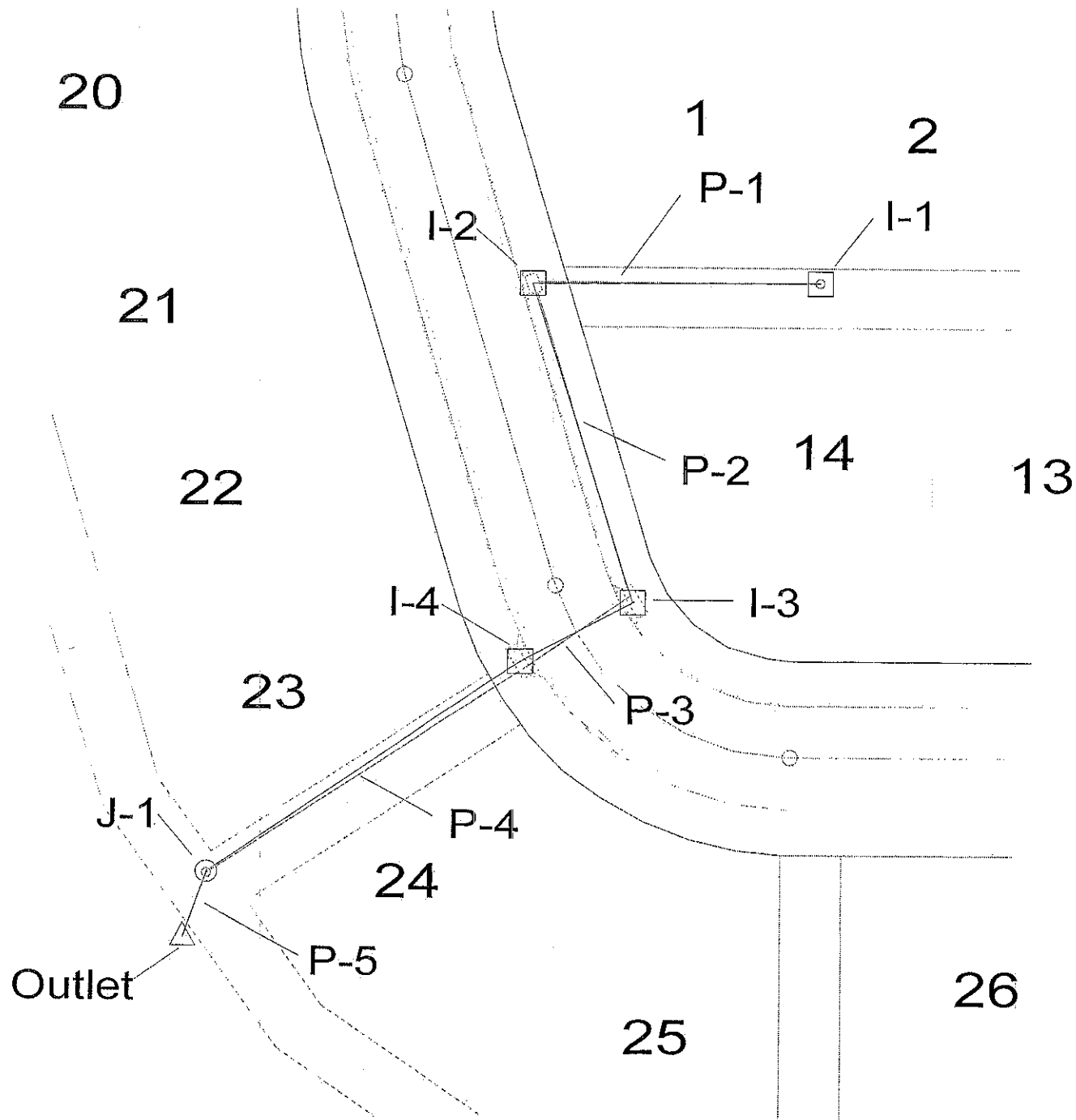

Coppergate 2nd Addition
 Stormwater Sewer System #2
 Inlet L-2

Drainage area, acres	0.4
LI = Inlet Length	5
So = street grade, f/ft	0.005
Sx = cross slope, f/ft	0.03125
Manning's n	0.022
Z in Izzard's Eq. = 1/Sx	32

	2-yr	5-yr	100-yr
Rainfall Intensity, in/hr	3.83	4.56	7.37
Rational "C"	0.46	0.49	0.67
Flowrate, cfs	0.7	0.9	2.0
Additional Flow, cfs	0.0	0.0	0.0
Total Flowrate, cfs	0.7	0.9	2.0
depth of flow, ft	0.19	0.21	0.28
Flow width, ft	6.14	6.71	9.03
Froude Number	0.63950	0.64907	0.68205
Length 1, ft	3.46	3.83	5.42
Length 2, ft	2.27	2.52	3.56
Length 3, ft	6.48	7.19	10.17
case 1, LI < L2 intercepted flow bypassed flow	NO GOOD 1.0 0.0	NO GOOD 1.2 0.0	NO GOOD 1.8 0.2
case 2, LI > L2 intercepted flow bypassed flow	VALID 0.6 0.1	VALID 0.8 0.1	VALID 1.5 0.5

System Report

Pipe	Additional Flow (cfs)	Total Upstream Added (cfs)	Structure Discharge (cfs)	-Node- Upstream Downstream	-Section- Shape Size	Upstream Invert Elevation (ft)	Downstream Invert Elevation (ft)	-Ground- Upstream Downstream (ft)	-HGL- Upstream Downstream (ft)	-Slope- Energy Constructed (ft/ft)	-Section- Discharge Capacity (cfs)	Length (ft)	Average Velocity (ft/s)	Description
P-1	4.20	0.00	4.20	I-1	Circular	164.40	164.00	167.90	165.25	0.004386	4.20	93.00	4.29	
P-2	0.80	4.20	5.00	I-2	18 inch	163.50	163.10	168.50	164.79	0.004301	6.89			
P-3	1.90	5.00	6.90	I-3	18 inch	162.60	162.40	168.50	164.51	0.003969	5.00	110.00	4.37	
P-4	4.90	6.90	11.80	I-4	24 inch	162.20	161.00	169.40	163.96	0.003636	6.33	41.00	3.53	
P-5	N/A	11.80	11.80	J-1	24 inch	162.20	161.00	169.40	163.70	0.004878	15.80	124.00	6.49	
				J-1	24 inch	160.50	160.00	168.10	162.04	0.009677	22.25			
				Outlet	24 inch	160.50	160.00	168.10	161.88	0.002777	11.80	23.00	4.44	
								166.00	162.00	0.021739	33.35			

Junction: J-1
 Rim: 168.10 ft
 Sump: 160.50 ft

Inlet: I-3
 Rim: 169.40 ft
 Sump: 162.60 ft

Inlet: I-1
 Rim: 167.90 ft
 Sump: 164.40 ft

Inlet: I-4
 Rim: 169.40 ft
 Sump: 162.20 ft

Inlet: I-2
 Rim: 168.50 ft
 Sump: 163.50 ft

Outlet: Outlet
 Rim: 166.00 ft
 Sump: 160.00 ft

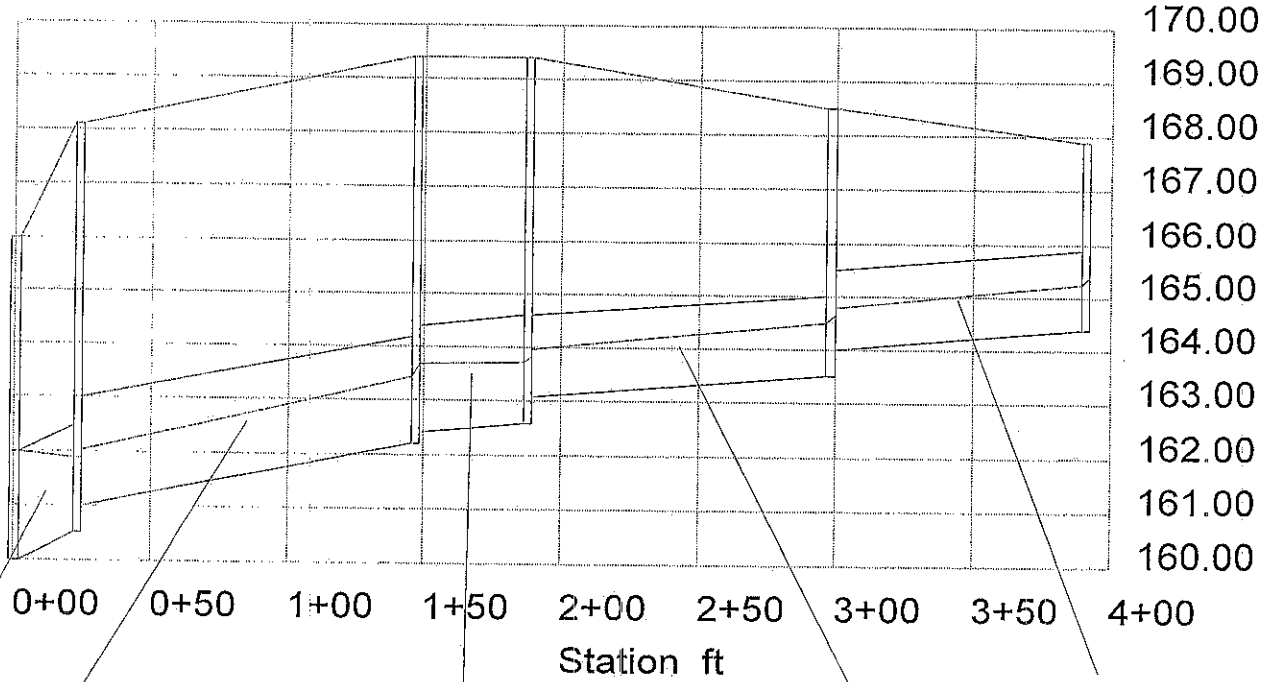

Elevation ft

Pipe: P-4
 Up Invert: 162.20 ft
 Dn Invert: 161.00 ft
 Length: 124.00 ft
 Size: 24 inch

Pipe: P-1
 Up Invert: 164.40 ft
 Dn Invert: 164.00 ft
 Length: 93.00 ft
 Size: 18 inch

Pipe: P-5
 Up Invert: 160.50 ft
 Dn Invert: 160.00 ft
 Length: 23.00 ft
 Size: 24 inch

Pipe: P-3
 Up Invert: 162.60 ft
 Dn Invert: 162.40 ft
 Length: 41.00 ft
 Size: 24 inch

Pipe: P-2
 Up Invert: 163.50 ft
 Dn Invert: 163.10 ft
 Length: 110.00 ft
 Size: 18 inch

System Report

Pipe	Additional Flow (cfs)	Total Upstream Added (cfs)	Structure Discharge (cfs)	-Node- Upstream Downstream	-Section- Shape Size	Upstream Invert Elevation (ft)	Downstream Invert Elevation (ft)	-Ground- Upstream Downstream (ft)	-HGL- Upstream Downstream (ft)	-Slope- Energy Constructed (ft/ft)	-Section- Discharge Capacity (cfs)	Length (ft)	Average Velocity (ft/s)	Description
P-1	9.40	0.00	9.40	I-1	Circular	164.40	164.00	167.90	167.68	0.008009	9.40	93.00	5.32	
P-2	1.50	9.40	10.90	I-2	Circular	163.50	163.10	168.50	166.93	0.004301	6.89	110.00	6.17	
				I-3	18 inch			169.40	165.45	0.003636	6.33			
P-3	4.40	10.90	15.30	I-3	Circular	162.60	162.40	169.40	165.27	0.004575	15.30	41.00	4.87	
				I-4	24 inch			169.40	165.08	0.004878	15.80			
P-4	10.90	15.30	26.20	I-4	Circular	162.20	161.00	169.40	164.54	0.013040	26.20	124.00	8.58	
P-5	N/A	26.20	26.20	J-1	24 inch	160.50	160.00	168.10	162.79	0.009677	22.25	23.00	8.58	
				Outlet	24 inch			166.00	162.00	0.021739	33.35			

Junction: J-1
 Rim: 168.10 ft
 Sump: 160.50 ft

Inlet: I-3
 Rim: 169.40 ft
 Sump: 162.60 ft

Inlet: I-1
 Rim: 167.90 ft
 Sump: 164.40 ft

Outlet: Outlet
 Rim: 166.00 ft
 Sump: 160.00 ft

Inlet: I-4
 Rim: 169.40 ft
 Sump: 162.20 ft

Inlet: I-2
 Rim: 168.50 ft
 Sump: 163.50 ft

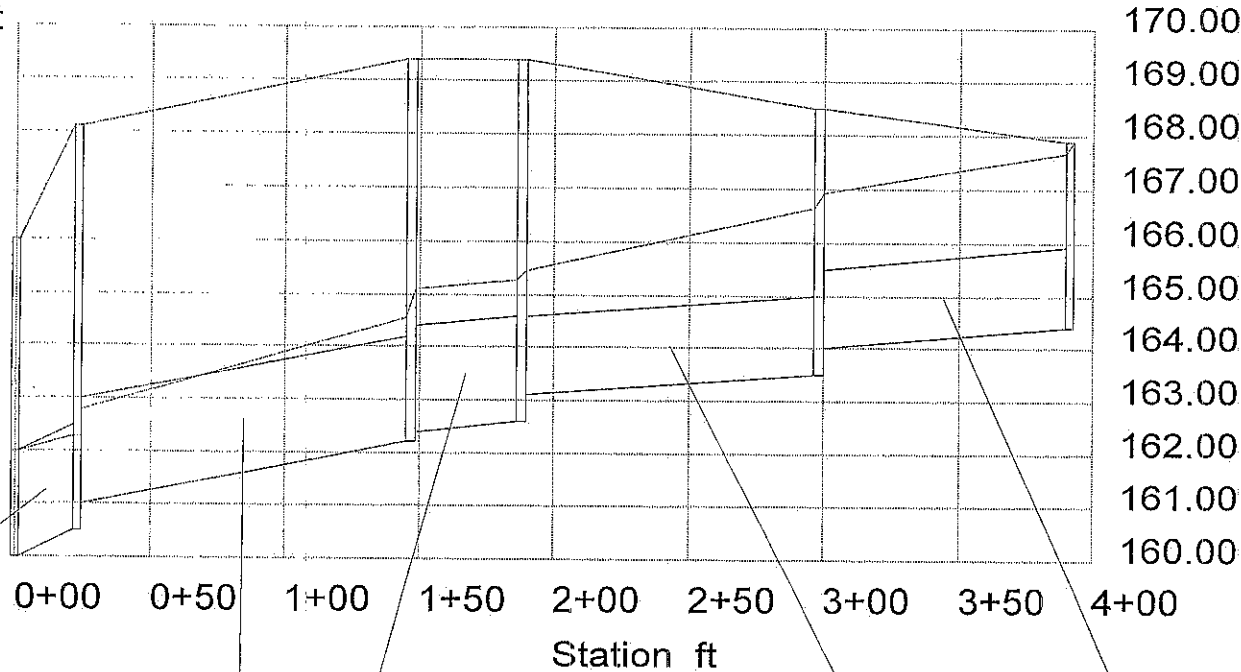

Pipe: P-5
 Up Invert: 160.50 ft
 Dn Invert: 160.00 ft
 Length: 23.00 ft
 Size: 24 inch

Pipe: P-3
 Up Invert: 162.60 ft
 Dn Invert: 162.40 ft
 Length: 41.00 ft
 Size: 24 inch

Pipe: P-4
 Up Invert: 162.20 ft
 Dn Invert: 161.00 ft
 Length: 124.00 ft
 Size: 24 inch

Pipe: P-2
 Up Invert: 163.50 ft
 Dn Invert: 163.10 ft
 Length: 110.00 ft
 Size: 18 inch

Pipe: P-1
 Up Invert: 164.40 ft
 Dn Invert: 164.00 ft
 Length: 93.00 ft
 Size: 18 inch

Elevation ft

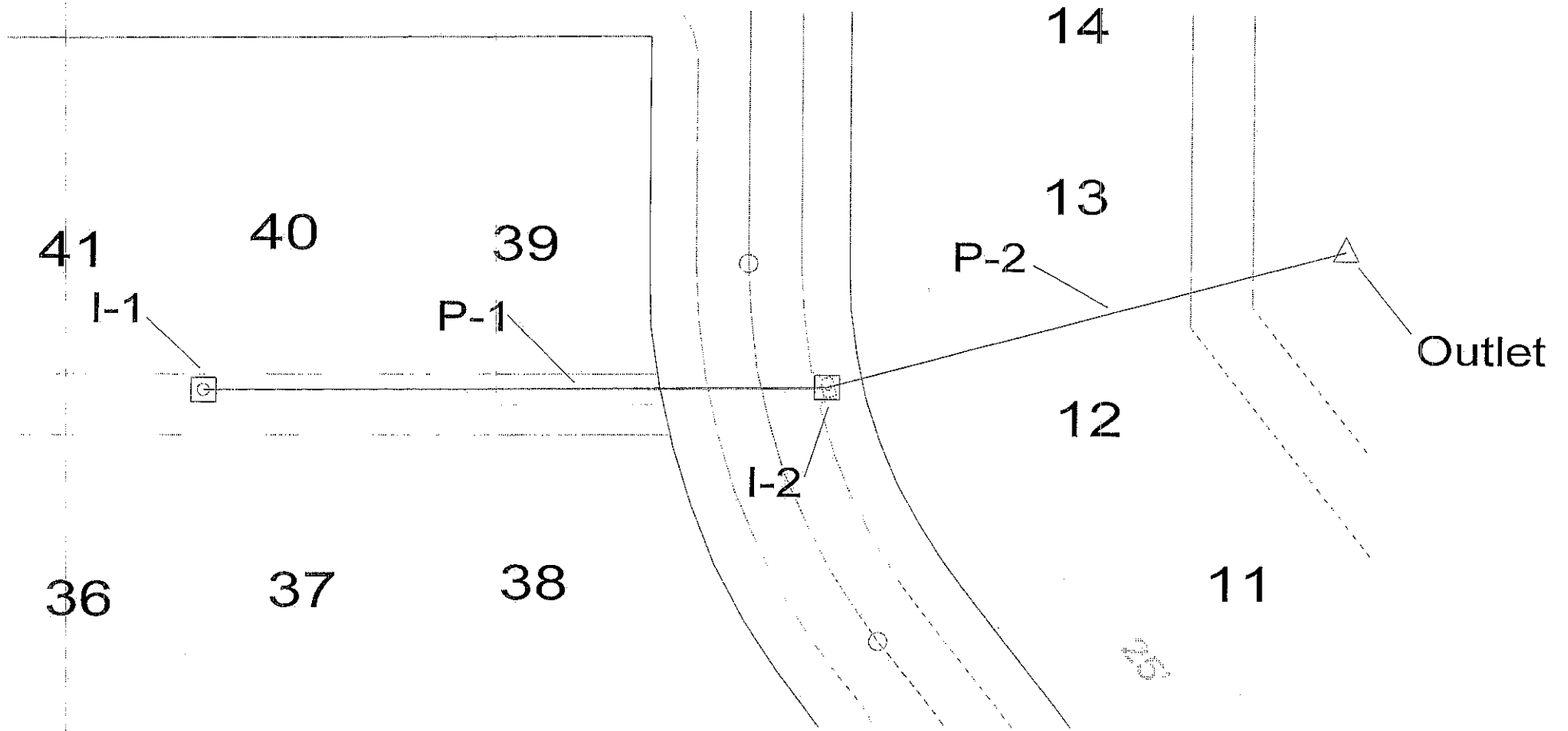

Coppergate 2nd Addition
 Stormwater Sewer System #3
 Inlet L-2

Drainage area, acres	0.2
Li = Inlet Length	5
So = street grade, ft/ft	0.00527
Sx = 'cross slope, ft/ft	0.03125
Manning's n	0.022
Z in Izzard's Eq. = 1/Sx	32

	2-yr	5-yr	100-yr
Rainfall Intensity, in/hr	3.83	4.56	7.37
Rational "C"	0.46	0.49	0.67
Flowrate, cfs	0.4	0.4	1.0
Additional Flow, cfs	0.0	0.0	0.0
Total Flowrate, cfs	0.4	0.4	1.0
depth of flow, ft	0.15	0.16	0.22
Flow width, ft	4.69	5.12	6.90
Froude Number	0.62767	0.63706	0.66943
Length 1, ft	2.59	2.87	4.06
Length 2, ft	1.70	1.89	2.67
Length 3, ft	4.85	5.39	7.62
case 1, Li < L2 intercepted flow bypassed flow	NO GOOD 0.7 0.0	NO GOOD 0.8 0.0	NO GOOD 1.2 0.0
case 2, Li > L2 intercepted flow bypassed flow	VALID 0.4 0.0	VALID 0.4 0.0	VALID 0.8 0.2

System Report

Pipe	Additional Flow (cfs)	Total Upstream Added (cfs)	Structure Discharge (cfs)	-Node- Upstream Downstream	-Section- Shape Size	Upstream Invert Elevation (ft)	Downstream Invert Elevation (ft)	-Ground- Upstream Downstream (ft)	-HGL- Upstream Downstream (ft)	-Slope- Energy Constructed (ft/ft)	-Section- Discharge Capacity (cfs)	Length (ft)	Average Velocity (ft/s)	Description
P-1	3.40	0.00	3.40	I-1	Circular	165.70	164.90	169.20	166.57	0.004163	3.40	200.00	4.10	
P-2	0.40	3.40	3.80	I-2 Outlet	15 inch Circular	164.70	158.50	170.60 167.50	165.64 162.20	0.004000 0.020148	4.09 3.80	172.00	3.24	

Inlet: I-2
Rim: 170.60 ft
Sump: 164.70 ft

Inlet: I-1
Rim: 169.20 ft
Sump: 165.70 ft

Outlet: Outlet
Rim: 167.50 ft
Sump: 158.50 ft

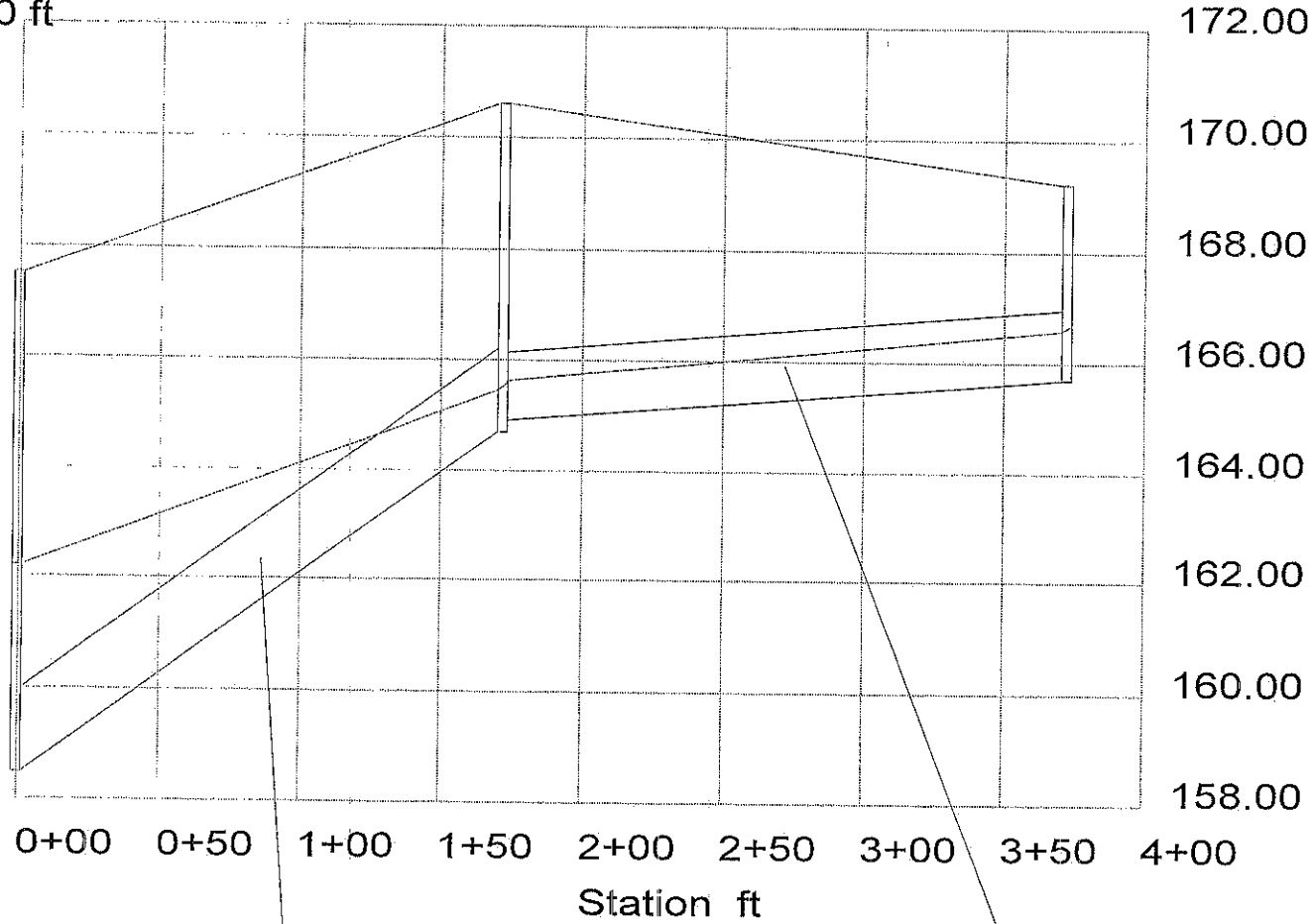

Pipe: P-2
Up Invert: 164.70 ft
Dn Invert: 158.50 ft
Length: 172.00 ft
Size: 18 inch

Pipe: P-1
Up Invert: 165.70 ft
Dn Invert: 164.90 ft
Length: 200.00 ft
Size: 15 inch

System Report

Pipe	Additional Flow (cfs)	Total Upstream Added (cfs)	Structure Discharge (cfs)	-Node- Upstream Downstream	-Section- Shape Size	Upstream Invert Elevation (ft)	Downstream Invert Elevation (ft)	-Ground- Upstream Downstream (ft)	-HGL- Upstream Downstream (ft)	-Slope- Energy Constructed (ft/ft)	-Section- Discharge Capacity (cfs)	Length (ft)	Average Velocity (ft/s)	Description
P-1	7.40	0.00	7.40	I-1	Circular	165.70	164.90	169.20	168.72	0.013086	7.40	200.00	6.11	
P-2	0.80	7.40	8.20	I-2 Outlet	Circular 18 inch	164.70	158.50	170.60 167.50	166.08 165.81 162.20	0.004000 0.022133 0.036047	4.09 8.20 19.94	172.00	5.25	

Outlet: Outlet
Rim: 167.50 ft
Sump: 158.50 ft

Inlet: I-2
Rim: 170.60 ft
Sump: 164.70 ft

Inlet: I-1
Rim: 169.20 ft
Sump: 165.70 ft

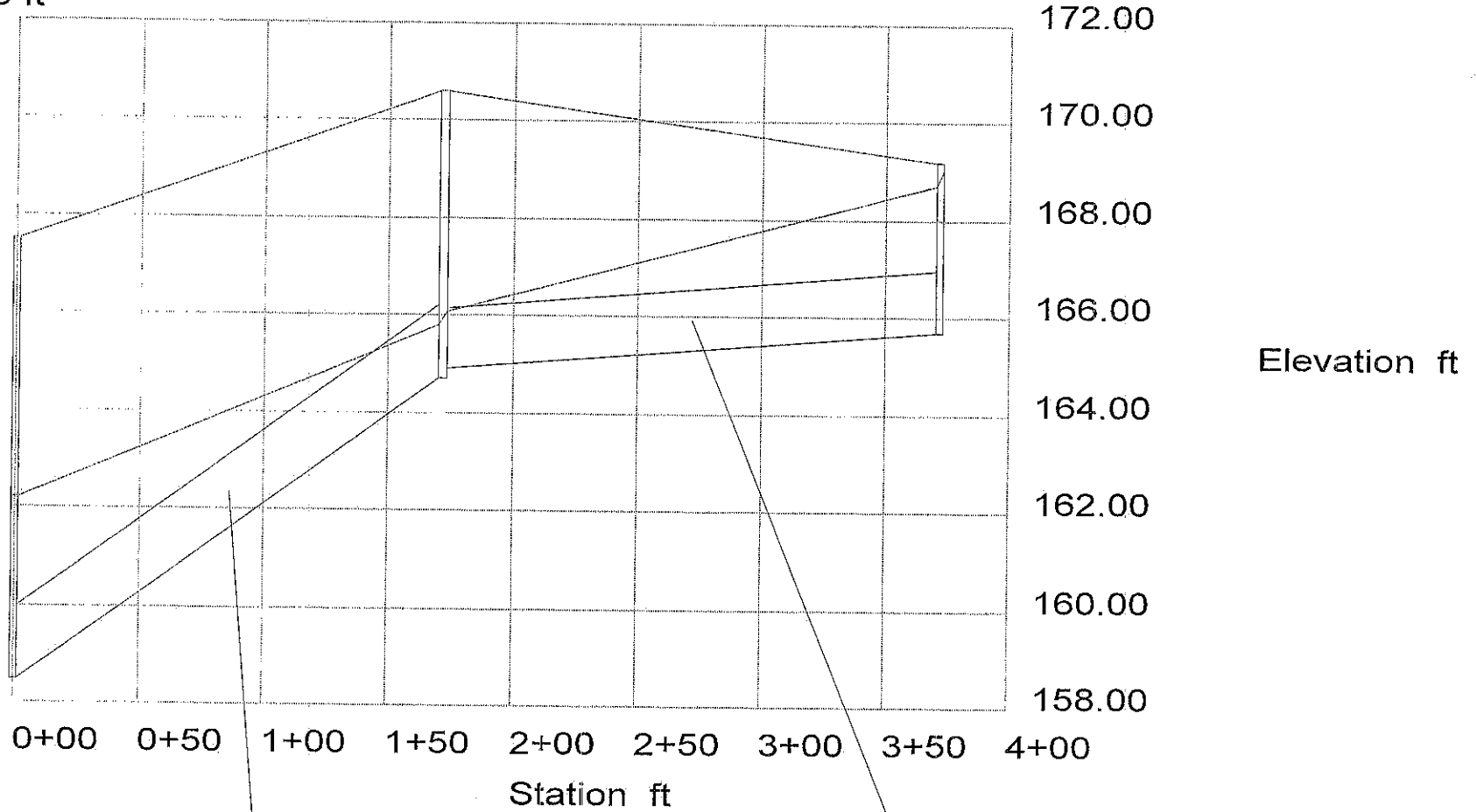

Pipe: P-2
Up Invert: 164.70 ft
Dn Invert: 158.50 ft
Length: 172.00 ft
Size: 18 inch

Pipe: P-1
Up Invert: 165.70 ft
Dn Invert: 164.90 ft
Length: 200.00 ft
Size: 15 inch

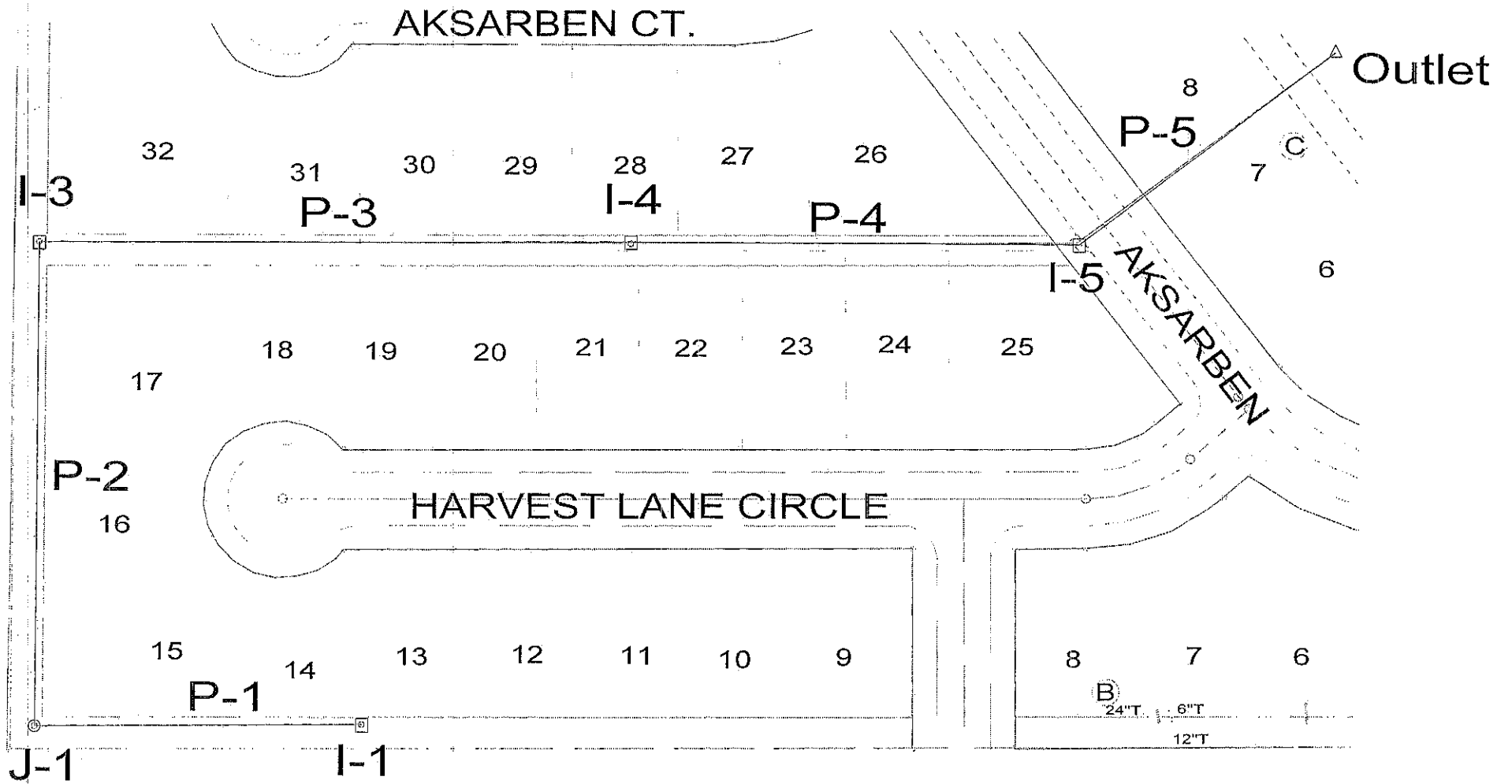

Coppergate 2nd Addition
 Stormwater Sewer System #4
 Inlet I-5

Drainage area, acres	1.1
Li = Inlet Length	10
So = street grade, ft/ft	0.01421
Sx = cross slope, ft/ft	0.03126
Manning's n	0.022
Z in Izzard's Eq. = 1/Sx	32

	2-yr	5-yr	100-yr
Rainfall Intensity, in/hr	3.83	4.56	7.37
Rational "C"	0.46	0.49	0.67
Flowrate, cfs	1.9	2.5	5.4
Additional Flow, cfs	0.0	0.0	0.0
Total Flowrate, cfs	1.9	2.5	5.4
depth of flow, ft	0.23	0.25	0.34
Flow width, ft	7.37	8.06	10.85
Froude Number	1.11156	1.12820	1.18562
Length 1, ft	7.22	8.01	11.33
Length 2, ft	4.74	5.26	7.44
Length 3, ft	13.52	15.01	21.23
case 1, Li < L2 intercepted flow bypassed flow	NO GOOD 2.7 0.0	NO GOOD 3.1 0.0	NO GOOD 4.8 0.6
case 2, Li > L2 intercepted flow bypassed flow	VALID 1.7 0.2	VALID 2.1 0.4	VALID 4.0 1.4

System Report

Pipe	Additional Flow (cfs)	Total Upstream Added (cfs)	Structure Discharge (cfs)	-Node- Upstream Downstream	-Section- Shape Size	Upstream Invert Elevation (ft)	Downstream Invert Elevation (ft)	-Ground- Upstream Downstream (ft)	-HGL- Upstream Downstream (ft)	-Slope- Energy Constructed (ft/ft)	-Section- Discharge Capacity (cfs)	Length (ft)	Average Velocity (ft/s)	Description
P-1	0.90	0.00	0.90	I-1	Circular	165.10	164.30	168.60	165.50	0.003903	0.90	206.00	2.79	
P-2	N/A	0.90	0.90	J-1	Circular	164.20	163.00	168.60	164.67	0.003883	4.03			
P-3	2.70	0.90	3.60	I-3	Circular	162.70	161.50	168.60	163.65	0.003871	4.02	310.00	2.02	
P-4	4.20	3.60	7.80	I-4	Circular	161.00	160.40	168.60	163.55	0.001677	3.60	374.00	2.75	
P-5	2.10	7.80	9.90	I-5	Circular	160.00	158.00	167.00	163.05	0.003209	5.95	282.00	2.48	
				Outlet	Circular			169.80	162.67	0.002128	10.43			
					24 inch			169.80	162.59	0.001915	9.90	203.00	3.15	
								166.50	162.20	0.009852	22.45			

Outlet: Outlet
Rim: 166.50 ft
Sump: 158.00 ft

Inlet: I-5
Rim: 169.80 ft
Sump: 160.00 ft

Inlet: I-4
Rim: 167.00 ft
Sump: 161.00 ft

Inlet: I-3
Rim: 168.60 ft
Sump: 162.70 ft

Junction: J-1
Rim: 168.60 ft
Sump: 164.20 ft

Inlet: I-1
Rim: 168.60 ft
Sump: 165.10 ft

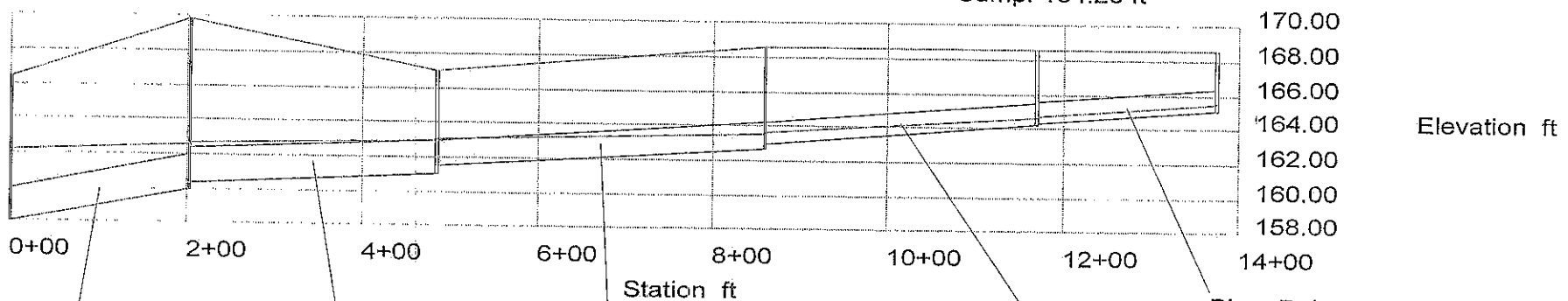

Pipe: P-5
Up Invert: 160.00 ft
Dn Invert: 158.00 ft
Length: 203.00 ft
Size: 24 inch

Pipe: P-4
Up Invert: 161.00 ft
Dn Invert: 160.40 ft
Length: 282.00 ft
Size: 24 inch

Pipe: P-3
Up Invert: 162.70 ft
Dn Invert: 161.50 ft
Length: 374.00 ft
Size: 18 inch

Pipe: P-2
Up Invert: 164.20 ft
Dn Invert: 163.00 ft
Length: 310.00 ft
Size: 15 inch

Pipe: P-1
Up Invert: 165.10 ft
Dn Invert: 164.30 ft
Length: 206.00 ft
Size: 15 inch

System Report

Pipe	Additional Flow (cfs)	Total Upstream Added (cfs)	Structure Discharge (cfs)	-Node- Upstream Downstream	-Section- Shape Size:	Upstream Invert Elevation (ft)	Downstream Invert Elevation (ft)	-Ground- Upstream Downstream (ft)	-HGL- Upstream Downstream (ft)	-Slope- Energy Constructed (ft/ft)	-Section- Discharge Capacity (cfs)	Length (ft)	Average Velocity (ft/s)	Description
P-1	2.00	0.00	2.00	I-1	Circular	165.10	164.30	168.60	168.80	0.000959	2.00	206.00	1.63	
P-2	N/A	2.00	2.00	J-1	Circular	164.20	163.00	168.60	168.81	0.003883	4.03	310.00	1.63	
P-3	5.90	2.00	7.90	I-3	Circular	162.70	161.50	168.60	168.51	0.003871	4.02	374.00	4.47	
P-4	9.40	7.90	17.30	I-4	Circular	161.00	160.40	167.00	166.24	0.003209	5.95	282.00	5.51	
P-5	4.00	17.30	21.30	I-5	Circular	160.00	158.00	169.80	164.36	0.002128	10.43	203.00	6.78	
				Outlet	Circular			166.50	162.20	0.009852	22.45			

Inlet: I-5
Rim: 169.80 ft
Sump: 160.00 ft

Inlet: I-1
Rim: 168.60 ft
Sump: 165.10 ft

Outlet: Outlet
Rim: 166.50 ft
Sump: 158.00 ft

Inlet: I-4
Rim: 167.00 ft
Sump: 161.00 ft

Inlet: I-3
Rim: 168.60 ft
Sump: 162.70 ft

Junction: J-1
Rim: 168.60 ft
Sump: 164.20 ft

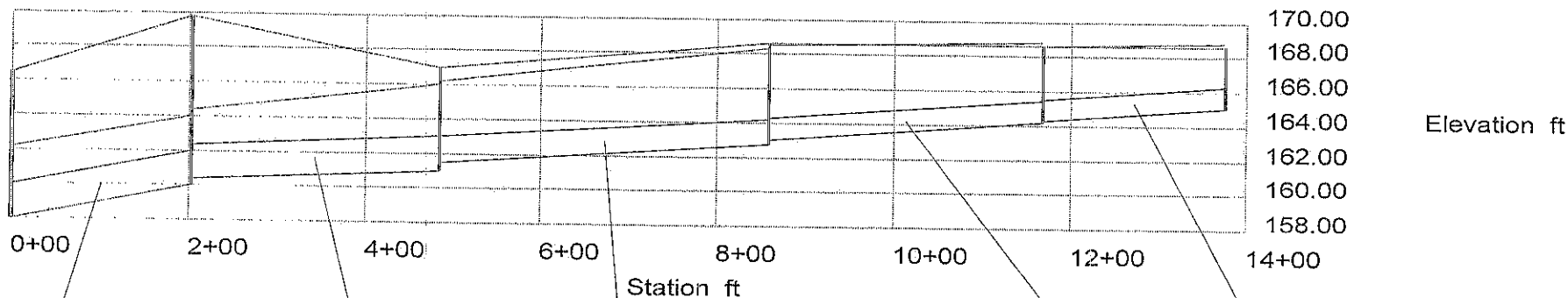

Pipe: P-5
Up Invert: 160.00 ft
Dn Invert: 158.00 ft
Length: 203.00 ft
Size: 24 inch

Pipe: P-4
Up Invert: 161.00 ft
Dn Invert: 160.40 ft
Length: 282.00 ft
Size: 24 inch

Pipe: P-3
Up Invert: 162.70 ft
Dn Invert: 161.50 ft
Length: 374.00 ft
Size: 18 inch

Pipe: P-1
Up Invert: 165.10 ft
Dn Invert: 164.30 ft
Length: 206.00 ft
Size: 15 inch

Pipe: P-2
Up Invert: 164.20 ft
Dn Invert: 163.00 ft
Length: 310.00 ft
Size: 15 inch

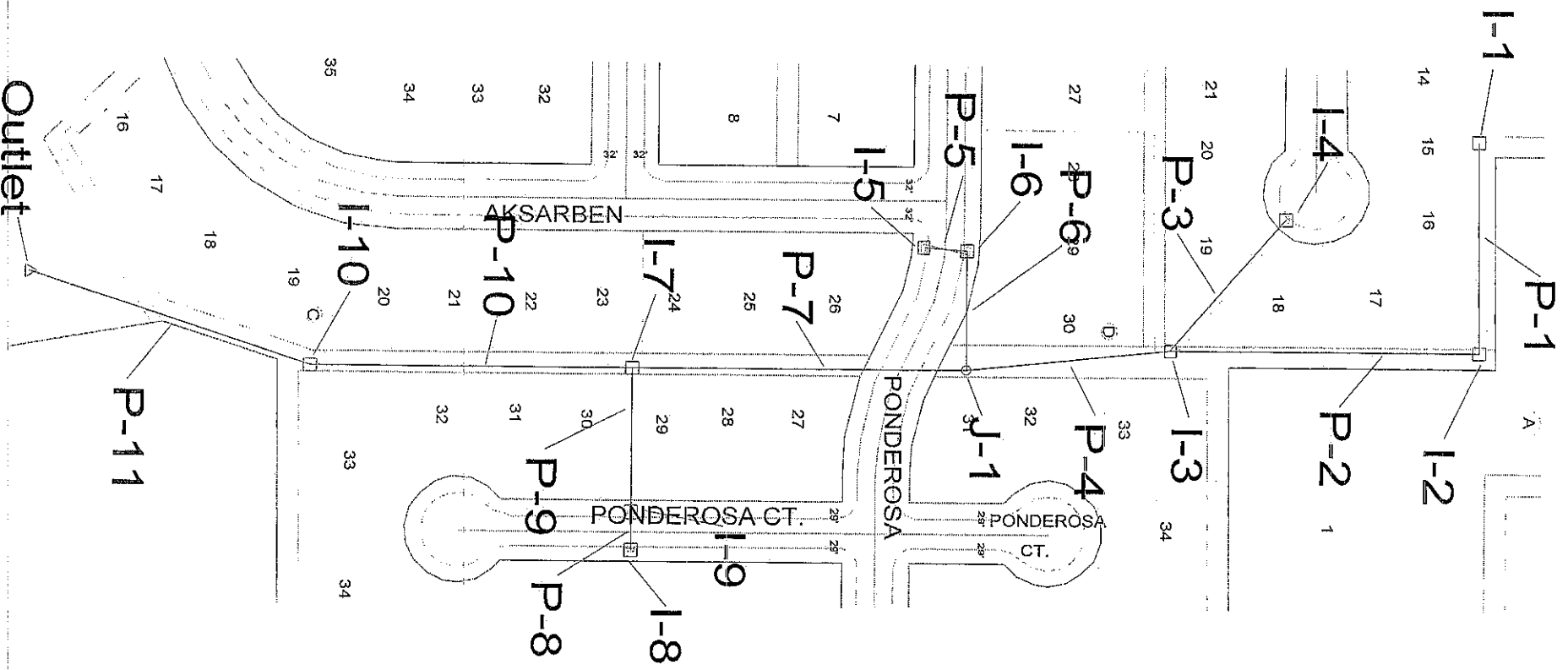

System Report

Pipe	Additional Flow (cfs)	Total Upstream Added (cfs)	Structure Discharge (cfs)	-Node- Upstream Downstream	-Section- Shape Size	Upstream Invert Elevation (ft)	Downstream Invert Elevation (ft)	-Ground- Upstream Downstream (ft)	-HGL- Upstream Downstream (ft)	-Slope- Energy Constructed (ft/ft)	-Section- Discharge Capacity (cfs)	Length (ft)	Average Velocity (ft/s)	Description
P-8	1.80	0.00	1.80	I-8	Circular 15 inch	166.50	166.30	170.40	167.09	0.002386	1.80	35.00	2.69	
P-9	2.20	1.80	4.00	I-9	Circular 15 inch	166.10	162.50	170.40	166.91	0.005714	4.88	137.00	4.01	
P-5	2.20	0.00	2.20	I-7	Circular 15 inch	168.50	168.30	170.50	164.01	0.022503	4.00	41.00	3.09	
P-6	1.80	2.20	4.00	I-5	Circular 15 inch	168.50	168.30	172.40	169.14	0.026277	10.47	2.20	3.09	
P-6	1.80	2.20	4.00	I-6	Circular 15 inch	168.10	165.00	172.40	169.09	0.004878	4.51	116.00	6.38	
P-3	2.90	0.00	2.90	J-1	Circular 15 inch	169.30	164.50	172.80	165.53	0.023542	4.00	168.00	3.50	
P-1	3.80	0.00	3.80	I-4	Circular 15 inch	169.30	164.50	173.20	169.98	0.026724	10.56	205.00	5.85	
P-2	1.10	3.80	4.90	I-3	Circular 15 inch	169.30	165.30	172.80	165.49	0.028571	10.92	290.00	2.93	
P-4	6.70	7.80	14.50	I-2	Circular 24 inch	165.00	164.10	168.80	165.87	0.019512	9.02	193.00	4.85	
P-7	N/A	18.50	18.50	I-3	Circular 36 inch	164.00	163.40	168.60	165.49	0.003103	12.60	316.00	4.35	
P-10	2.50	22.50	25.00	J-1	Circular 36 inch	162.90	162.20	172.80	164.74	0.003060	14.50	304.00	5.03	
P-11	2.90	25.00	27.90	I-7	Circular 36 inch	161.70	161.20	170.50	164.01	0.001954	18.50	279.00	5.33	
				I-10	Circular 36 inch	161.70	161.20	170.50	163.85	0.002215	31.39			
				I-10	Circular 36 inch	161.00	157.00	169.00	163.06	0.001645	27.05			
				Outlet	Circular 36 inch	161.00	157.00	169.00	162.71	0.003463	27.90			
								165.00	162.20	0.014337	79.86			

Inlet: I-10
Rim: 169.00 ft
Sump: 161.00 ft

Junction: J-1
Rim: 172.80 ft
Sump: 162.90 ft

Inlet: I-2
Rim: 168.80 ft
Sump: 165.00 ft

Outlet: Outlet
Rim: 165.00 ft
Sump: 157.00 ft

Inlet: I-7
Rim: 170.50 ft
Sump: 161.70 ft

Inlet: I-3
Rim: 168.60 ft
Sump: 164.00 ft

Inlet: I-1
Rim: 172.80 ft
Sump: 169.30 ft

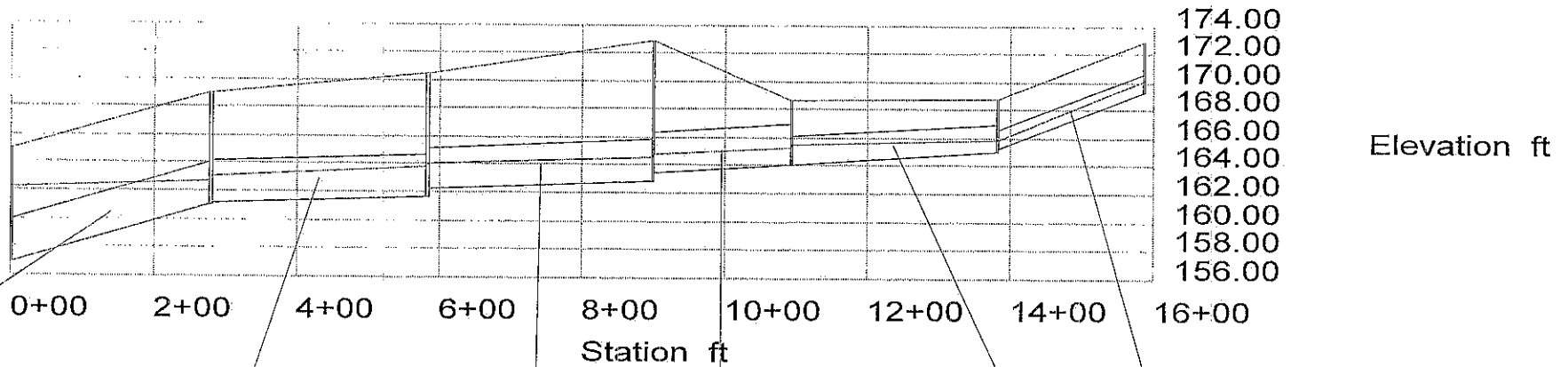

Pipe: P-11
Up Invert: 161.00 ft
Dn Invert: 157.00 ft
Length: 279.00 ft
Size: 36 inch

Pipe: P-10
Up Invert: 161.70 ft
Dn Invert: 161.20 ft
Length: 304.00 ft
Size: 36 inch

Pipe: P-7
Up Invert: 162.90 ft
Dn Invert: 162.20 ft
Length: 316.00 ft
Size: 36 inch

Pipe: P-4
Up Invert: 164.00 ft
Dn Invert: 163.40 ft
Length: 193.00 ft
Size: 36 inch

Pipe: P-2
Up Invert: 165.00 ft
Dn Invert: 164.10 ft
Length: 290.00 ft
Size: 24 inch

Pipe: P-1
Up Invert: 169.30 ft
Dn Invert: 165.30 ft
Length: 205.00 ft
Size: 15 inch

Outlet: Outlet
Rim: 165.00 ft
Sump: 157.00 ft

Inlet: I-7
Rim: 170.50 ft
Sump: 161.70 ft

Inlet: I-6
Rim: 172.40 ft
Sump: 168.10 ft

Inlet: I-5
Rim: 172.40 ft
Sump: 168.50 ft

Inlet: I-10
Rim: 169.00 ft
Sump: 161.00 ft

Junction: J-1
Rim: 172.80 ft
Sump: 162.90 ft

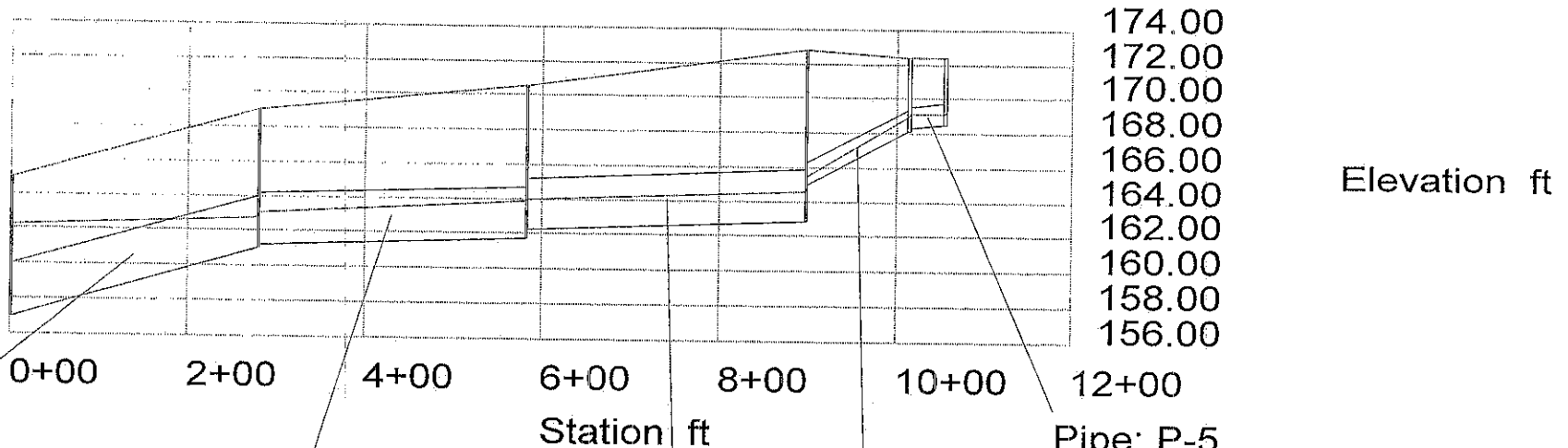

Pipe: P-11
Up Invert: 161.00 ft
Dn Invert: 157.00 ft
Length: 279.00 ft
Size: 36 inch

Pipe: P-10
Up Invert: 161.70 ft
Dn Invert: 161.20 ft
Length: 304.00 ft
Size: 36 inch

Pipe: P-7
Up Invert: 162.90 ft
Dn Invert: 162.20 ft
Length: 316.00 ft
Size: 36 inch

Pipe: P-6
Up Invert: 168.10 ft
Dn Invert: 165.00 ft
Length: 116.00 ft
Size: 15 inch

Pipe: P-5
Up Invert: 168.50 ft
Dn Invert: 168.30 ft
Length: 41.00 ft
Size: 15 inch

Inlet: I-7
Rim: 170.50 ft
Sump: 161.70 ft

Inlet: I-8
Rim: 170.40 ft
Sump: 166.50 ft

Outlet: Outlet
Rim: 165.00 ft
Sump: 157.00 ft

Inlet: I-10
Rim: 169.00 ft
Sump: 161.00 ft

Inlet: I-9
Rim: 170.40 ft
Sump: 166.10 ft

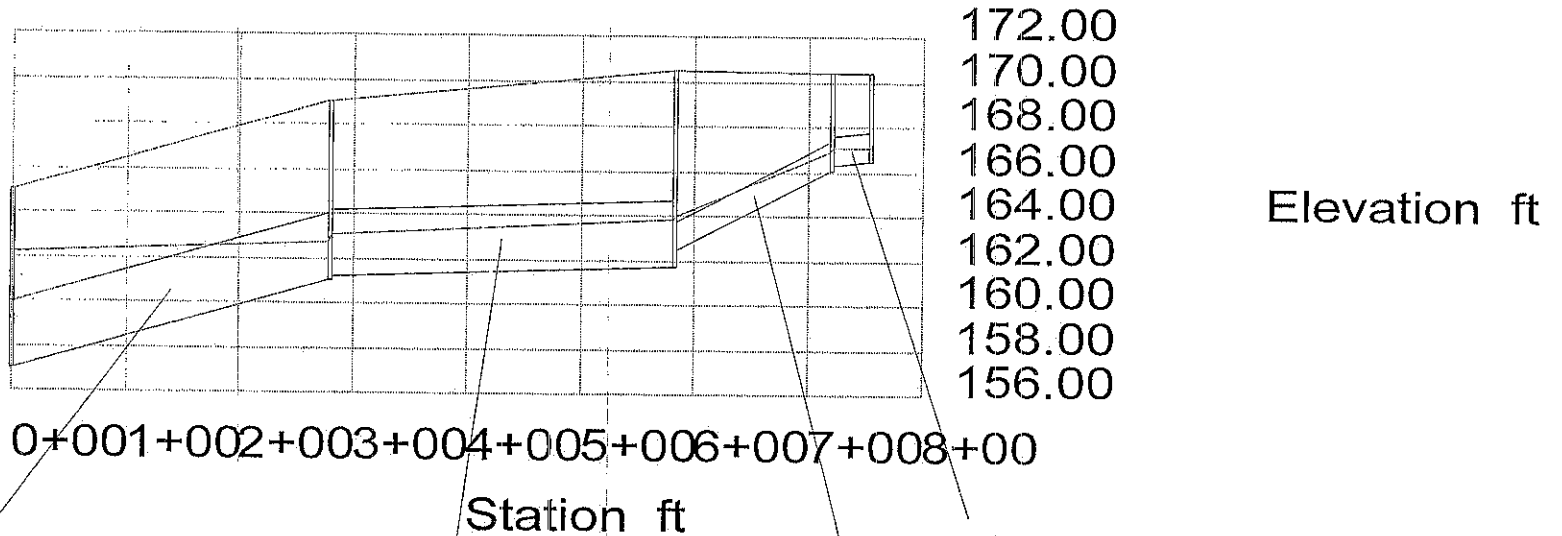

172.00
170.00
168.00
166.00
164.00
162.00
160.00
158.00
156.00

Elevation ft

0+001+002+003+004+005+006+007+008+00

Station ft

Pipe: P-8
Up Invert: 166.50 ft
Dn Invert: 166.30 ft
Length: 35.00 ft
Size: 15 inch

Pipe: P-11
Up Invert: 161.00 ft
Dn Invert: 157.00 ft
Length: 279.00 ft
Size: 36 inch

Pipe: P-10
Up Invert: 161.70 ft
Dn Invert: 161.20 ft
Length: 304.00 ft
Size: 36 inch

Pipe: P-9
Up Invert: 166.10 ft
Dn Invert: 162.50 ft
Length: 137.00 ft
Size: 15 inch

System Report

Pipe	Additional Flow (cfs)	Total Upstream Added (cfs)	Structure Discharge (cfs)	-Node- Upstream Downstream	-Section- Shape Size	Upstream Invert Elevation (ft)	Downstream Invert Elevation (ft)	-Ground- Upstream Downstream (ft)	-HGL- Upstream Downstream (ft)	-Slope- Energy Constructed (ft/ft)	-Section- Discharge Capacity (cfs)	Length (ft)	Average Velocity (ft/s)	Description
P-8	4.00	0.00	4.00	I-8	Circular	166.50	166.30	170.40	170.53	0.003835	4.00	35.00	3.26	
				I-9	15 inch			170.40	170.40	0.005714	4.88			
P-9	4.90	4.00	8.90	I-9	Circular	166.10	162.50	170.40	170.35	0.018984	8.90	137.00	7.25	
				I-7	15 inch			170.50	167.75	0.026277	10.47			
P-5	4.90	0.00	4.90	I-5	Circular	168.50	168.30	172.40	172.05	0.005754	4.90	41.00	3.99	
				I-6	15 inch			172.40	171.81	0.004878	4.51			
P-6	4.00	4.90	8.90	I-6	Circular	168.10	165.00	172.40	171.40	0.018984	8.90	116.00	7.25	
				J-1	15 inch			172.80	169.20	0.026724	10.56			
P-3	6.40	0.00	6.40	I-4	Circular	169.30	164.50	173.20	170.85	0.009817	6.40	168.00	5.22	
				I-3	15 inch			168.60	169.20	0.028571	10.92			
P-1	8.40	0.00	8.40	I-1	Circular	169.30	165.30	172.80	172.67	0.016911	8.40	205.00	6.84	
				I-2	15 inch			168.80	169.20	0.019512	9.02			
P-2	2.50	8.40	10.90	I-2	Circular	165.00	164.10	168.80	169.87	0.002322	10.90	290.00	3.47	
				I-3	24 inch			168.60	169.20	0.003103	12.60			
P-4	14.80	17.30	32.10	I-3	Circular	164.00	163.40	168.60	169.65	0.002316	32.10	193.00	4.54	
				J-1	36 inch			172.80	169.20	0.003109	37.19			
P-7	N/A	41.00	41.00	J-1	Circular	162.90	162.20	172.80	168.94	0.003779	41.00	316.00	5.80	
				I-7	36 inch			170.50	167.75	0.002215	31.39			
P-10	5.40	49.90	55.30	I-7	Circular	161.70	161.20	170.50	167.27	0.006875	55.30	304.00	7.82	
				I-10	36 inch			169.00	165.18	0.001645	27.05			
P-11	6.40	55.30	61.70	I-10	Circular	161.00	157.00	169.00	164.59	0.008558	61.70	279.00	8.73	
				Outlet	36 inch			165.00	162.20	0.014337	79.86			

Inlet: I-10
Rim: 169.00 ft
Sump: 161.00 ft

Inlet: I-3
Rim: 168.60 ft
Sump: 164.00 ft

Inlet: I-1
Rim: 172.80 ft
Sump: 169.30 ft

Outlet: Outlet
Rim: 165.00 ft
Sump: 157.00 ft

Inlet: I-7
Rim: 170.50 ft
Sump: 161.70 ft

Junction: J-1
Rim: 172.80 ft
Sump: 162.90 ft

Inlet: I-2
Rim: 168.80 ft
Sump: 165.00 ft

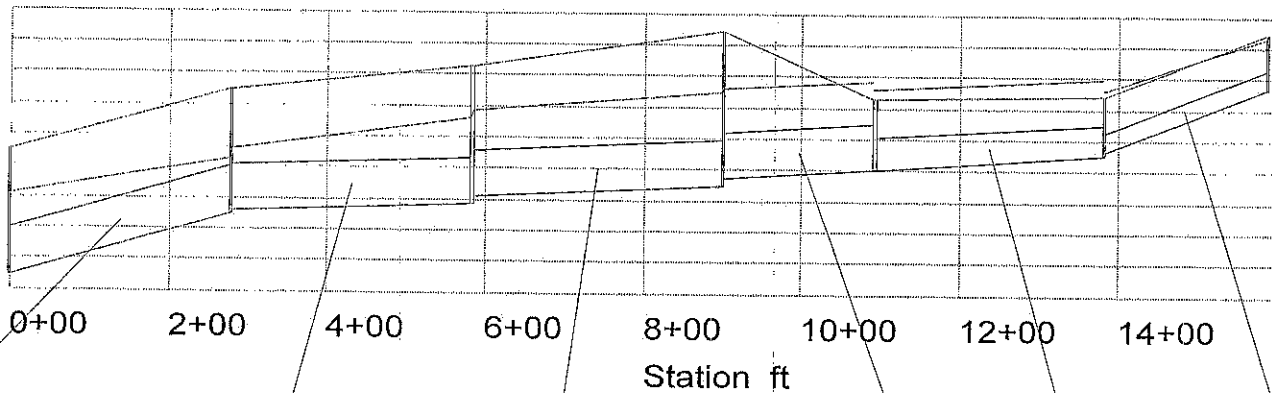

174.00
172.00
170.00
168.00
166.00
164.00
162.00
160.00
158.00
156.00

Elevation ft

0+00 2+00 4+00 6+00 8+00 10+00 12+00 14+00 16+00

Station ft

Pipe: P-11
Up Invert: 161.00 ft
Dn Invert: 157.00 ft
Length: 279.00 ft
Size: 36 inch

Pipe: P-10
Up Invert: 161.70 ft
Dn Invert: 161.20 ft
Length: 304.00 ft
Size: 36 inch

Pipe: P-7
Up Invert: 162.90 ft
Dn Invert: 162.20 ft
Length: 316.00 ft
Size: 36 inch

Pipe: P-1
Up Invert: 169.30 ft
Dn Invert: 165.30 ft
Length: 205.00 ft
Size: 15 inch

Pipe: P-2
Up Invert: 165.00 ft
Dn Invert: 164.10 ft
Length: 290.00 ft
Size: 24 inch

Pipe: P-4
Up Invert: 164.00 ft
Dn Invert: 163.40 ft
Length: 193.00 ft
Size: 36 inch

Inlet: I-10
Rim: 169.00 ft
Sump: 161.00 ft

Junction: J-1
Rim: 172.80 ft
Sump: 162.90 ft

Inlet: I-5
Rim: 172.40 ft
Sump: 168.50 ft

Outlet: Outlet
Rim: 165.00 ft
Sump: 157.00 ft

Inlet: I-7
Rim: 170.50 ft
Sump: 161.70 ft

Inlet: I-6
Rim: 172.40 ft
Sump: 168.10 ft

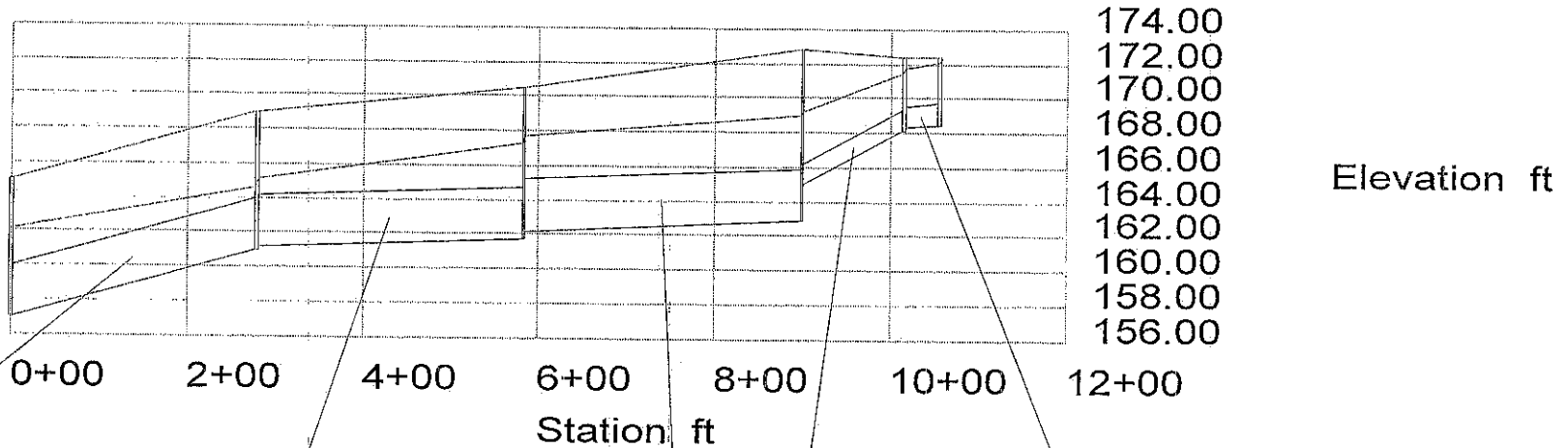

Pipe: P-11
Up Invert: 161.00 ft
Dn Invert: 157.00 ft
Length: 279.00 ft
Size: 36 inch

Pipe: P-10
Up Invert: 161.70 ft
Dn Invert: 161.20 ft
Length: 304.00 ft
Size: 36 inch

Pipe: P-7
Up Invert: 162.90 ft
Dn Invert: 162.20 ft
Length: 316.00 ft
Size: 36 inch

Pipe: P-6
Up Invert: 168.10 ft
Dn Invert: 165.00 ft
Length: 116.00 ft
Size: 15 inch

Pipe: P-5
Up Invert: 168.50 ft
Dn Invert: 168.30 ft
Length: 41.00 ft
Size: 15 inch

Inlet: I-10
Rim: 169.00 ft
Sump: 161.00 ft

Inlet: I-9
Rim: 170.40 ft
Sump: 166.10 ft

Inlet: I-8
Rim: 170.40 ft
Sump: 166.50 ft

Outlet: Outlet
Rim: 165.00 ft
Sump: 157.00 ft

Inlet: I-7
Rim: 170.50 ft
Sump: 161.70 ft

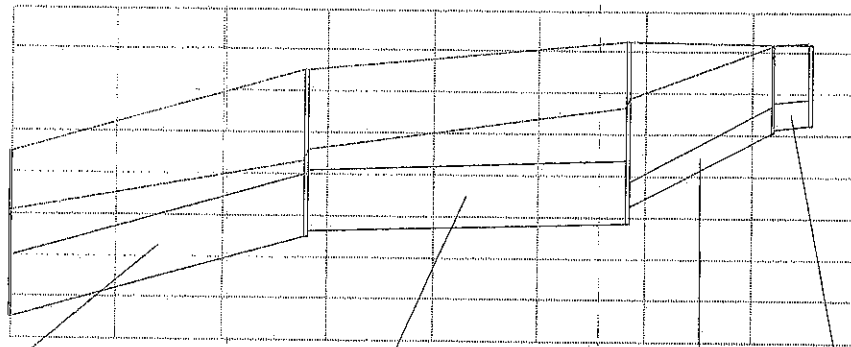

0+001+002+003+004+005+006+007+008+00

Station ft

172.00
170.00
168.00
166.00
164.00
162.00
160.00
158.00
156.00

Elevation ft

Pipe: P-8
Up Invert: 166.50 ft
Dn Invert: 166.30 ft
Length: 35.00 ft
Size: 15 inch

Pipe: P-9
Up Invert: 166.10 ft
Dn Invert: 162.50 ft
Length: 137.00 ft
Size: 15 inch

Pipe: P-11
Up Invert: 161.00 ft
Dn Invert: 157.00 ft
Length: 279.00 ft
Size: 36 inch

Pipe: P-10
Up Invert: 161.70 ft
Dn Invert: 161.20 ft
Length: 304.00 ft
Size: 36 inch