

DRAINAGE PLAN FOR NORTHWEST METHODIST ADDITION WICHITA, SEDGWICK COUNTY, KANSAS

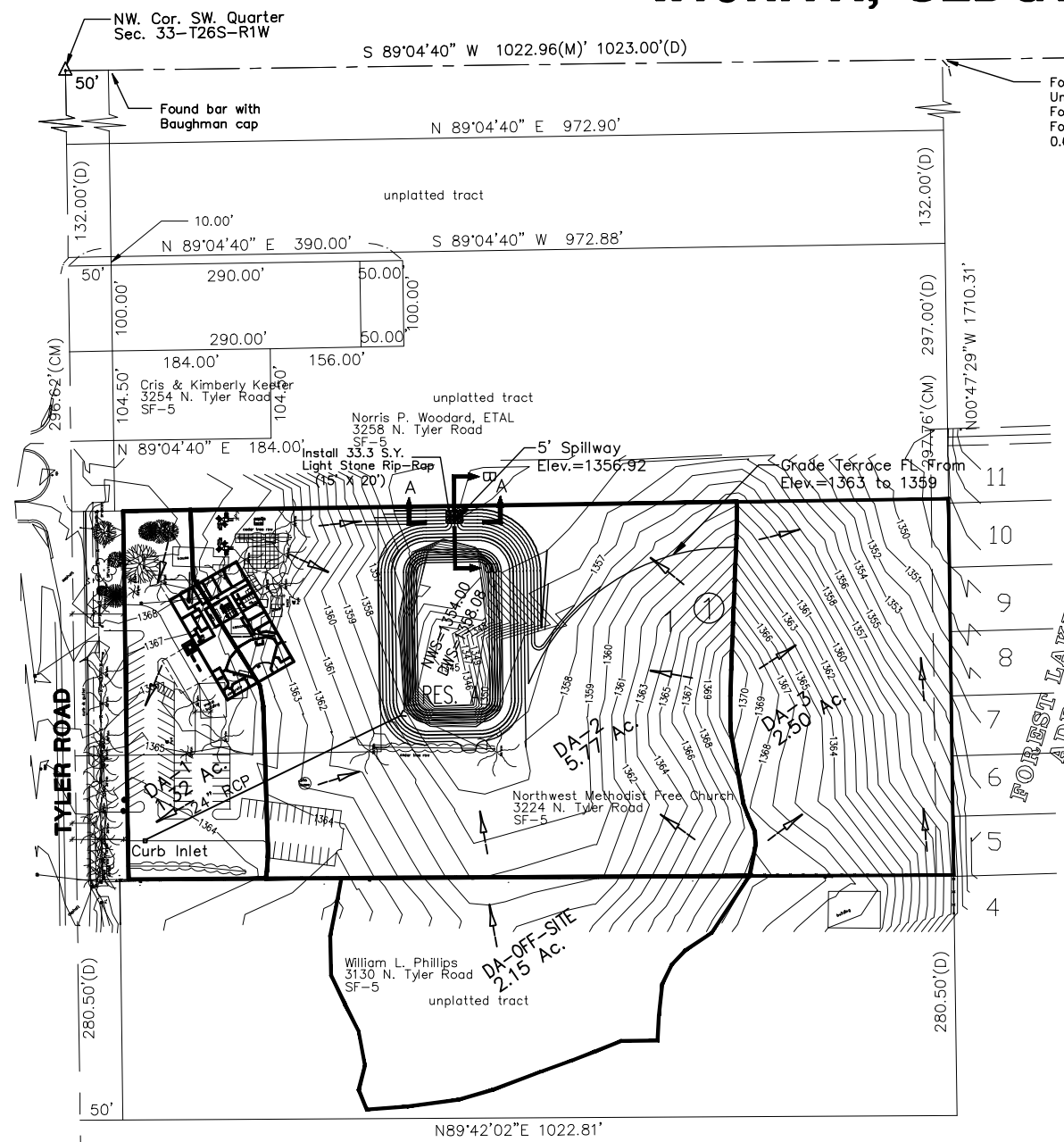
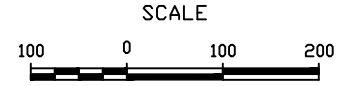
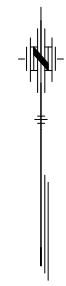

Area #	Area	c	i ₁₀₀	Undeveloped		Developed		Q ₅	Q ₁₀₀
				Q ₅	Q ₁₀₀	CN	CN		
1	1.32	4.62	7.40	2.02	5.58	72.0	91.1	3.12	6.46
2	5.77	4.62	7.40	8.80	24.35	72.0	73.4	13.60	28.20
3	2.50	4.62	7.40	3.81	10.55	72.0	72.0	*	*
Offsite	2.15	4.62	7.40	3.28	9.06	72.0	72.0	*	*

* Undeveloped

LEGEND

- = 1/2" Iron Pipe (found)
- ✱ = 1/2" Rebar (found)
- = PK Nail (found)
- + = "+" Cut (found)
- ▲ = Section Corner
- (M) = Measured
- (P) = Platted
- R.O.W. = Right-of-Way

Elevation	Acres	Storage Acre-Ft.	Total Storage Acre-Ft.	Q ₅ [^]	Q ₁₀₀
1358.08	0.92	0.07	3.20		21.51
1358.00	0.91	0.88	3.13		19.11
1357.00	0.85	0.15	2.25		0.74
1356.92	0.83	0.66	2.10	0.60	0.52
1356.00	0.78	0.75	1.44	0.40	0.40
1355.00	0.72	0.69	0.69	0.25	0.25
1354.00	0.66	0.00	0.00	0.00	0.00

Elevation	Acres	Storage Acre-Ft.	Total Storage Acre-Ft.	Existing	
				Q ₅	Q ₁₀₀
1354.36	0.62	0.21	2.95		25.43
1354.00	0.52	0.50	2.74		0.00
1353.00	0.48	0.46	2.25		0.00
1352.00	0.44	0.32	1.79		0.00
1351.25	0.41	0.10	1.46	0.00	0.00
1351.00	0.40	0.38	1.37	0.00	0.00
1350.00	0.36	0.34	0.98	0.00	0.00
1349.00	0.33	0.27	0.64	0.00	0.00
1348.00	0.21	0.18	0.37	0.00	0.00
1347.00	0.15	0.13	0.19	0.00	0.00
1346.00	0.10	0.06	0.06	0.00	0.00
1345.00	0.02	0.00	0.00	0.00	0.00

[^] Drawdown through 4" pipe takes just over 63 hours. The existing flow does not account for 1.88 cfs of runoff north of the existing pond during 5-yr. event. Approx. 1.23 Acres drains directly to the north property instead of entering the existing pond.

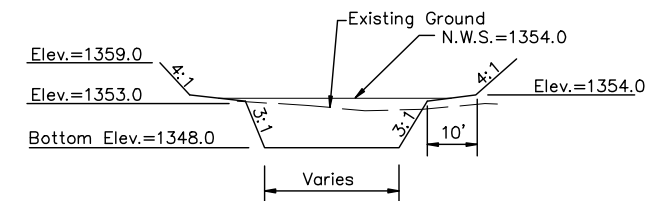

TYPICAL POND GRADING

LEGAL DESCRIPTION

A tract of land in the Southwest Quarter of Section 33, T26S, R1W of the 6th P.M., Sedgwick County, Kansas, being more particularly described as: Going Northerly on the West line of Section 33, T26S, R1W, a distance of 1221.00 feet North from the Southwest corner of said section for a point of beginning, thence turning right deflecting 90°29' 21" and going Easterly a distance of 1023.00 feet, thence turning left deflecting 90°29'21" and going Northerly a distance of 438.97 feet, thence turning left deflecting 90°04' and going Westerly on a line 1650 feet North of and parallel with the South line of the Section, a distance of 666.00 feet, thence turning left deflecting 89°56' and going Southerly a distance of 288.38 feet, thence turning right deflecting 90°29'21" and going Westerly a distance of 357.00 feet to the West line of the Section, thence turning right (~~left~~) and going South 144.10 feet to the point of beginning enclosing 7.84 acres more or less.

AND:
Beginning at a point on the West line of Section Thirty-three (33), Township Twenty-six (26) South, Range One (1) West, a distance of 1365.00 feet North of the Southwest Corner of said Section Thirty-three (33), thence going Northerly on the same line a distance of 284.90 feet, thence turning right deflecting 89°56' and going Easterly on a line 1650.10 feet North of and parallel with the South line of said Section Thirty-three (33), a distance of 357.00 feet, thence turning right deflecting 90°04' and going Southerly a distance of 288.38 feet, thence turning right deflecting 29°29'20" and thence going Westerly a distance of 357.00 feet to the point of beginning, enclosing an area of 2.35 acres, more or less.

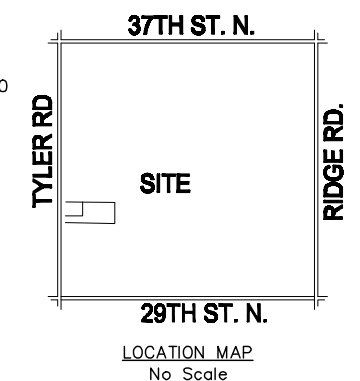

LOCATION MAP
No Scale

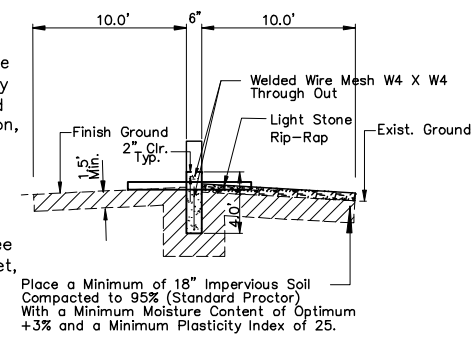

SECTION B-B
No Scale

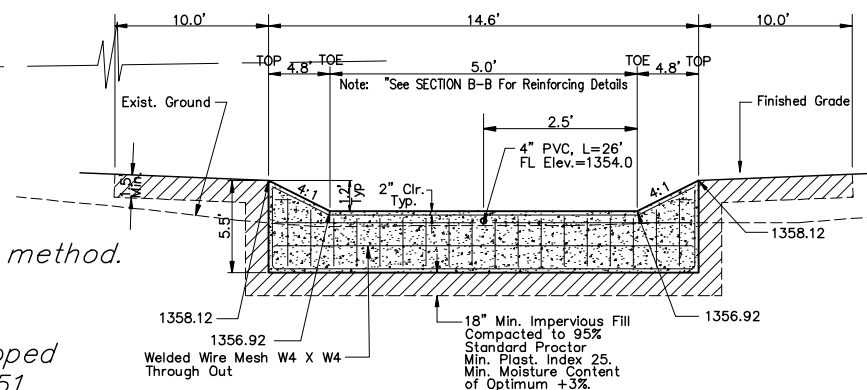

SECTION A-A
No Scale

NOTES:

- Determination of Q's was made using the rational method.
- c's used were as follows:

	Undeveloped	Developed
5yr frequency	0.33	0.51
100 yr frequency	0.57	0.66

Revision

Approved

By

Date

No.

NORTHWEST METHODIST ADDITION
DRAINAGE PLAN
CITY OF WICHITA, KANSAS
JIM ARMOUR P.E. - CITY ENGINEER

POE & ASSOCIATES, INC.
CONSULTING ENGINEERS
8940 E. Central, Suite 200 • Wichita, KS 67208-0242
Phone 316/685-4114 • FAX 316/685-4444

PRELIM

Designed By: T. Austin
Drawn By: S. Schmidt
B74\Drainage.dwg
Date: 07/05/06