

4MC-089

SHEET 1
OF 8

PLANS

SANITARY SEWER SYSTEM

NORTH POINT ADDITION

CRESTVIEW COUNTRY CLUB ESTATES

REISS AND GOODNESS ENGINEERS
2160 EAST DOUGLAS
WICHITA — KANSAS

1970

4mc-089

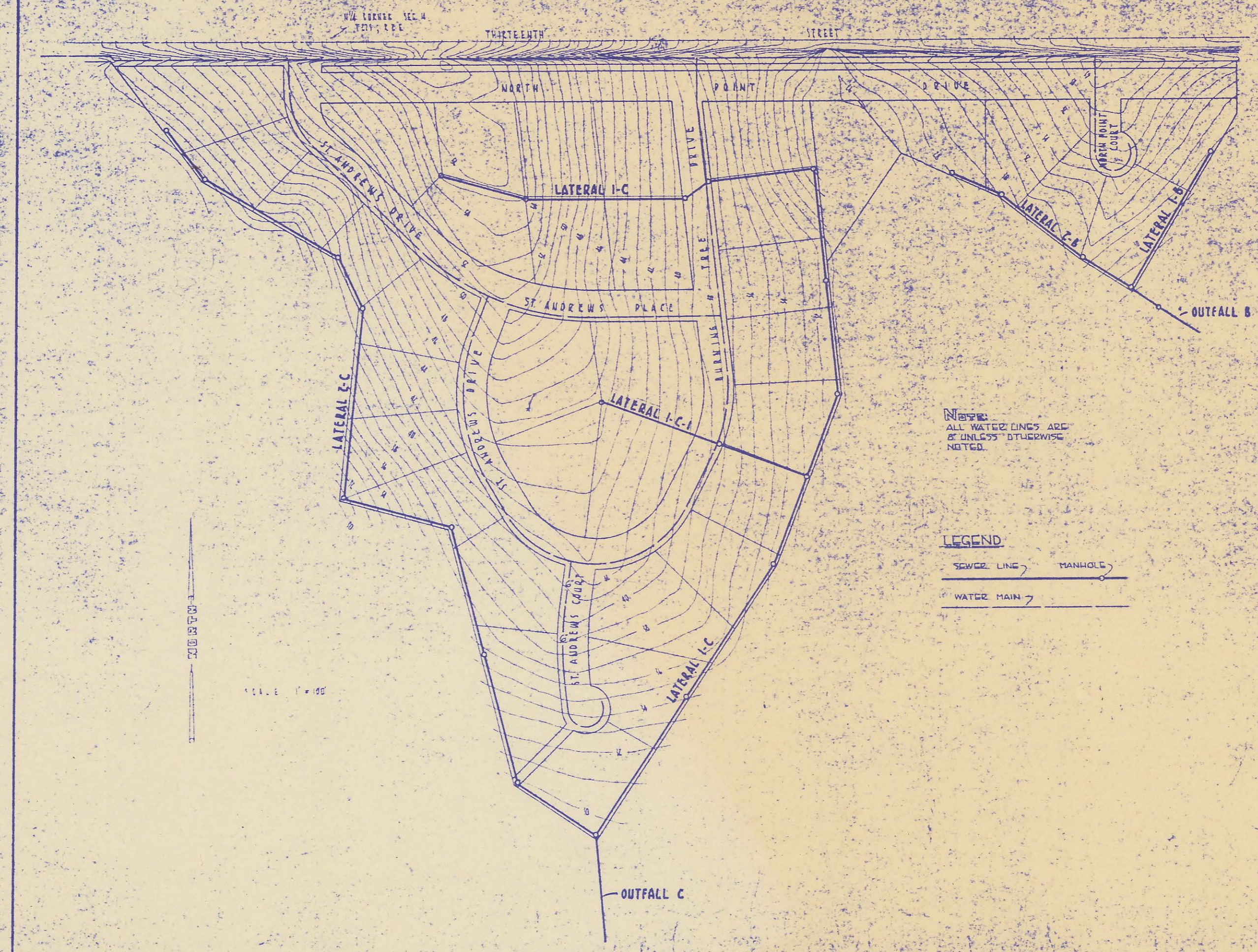

NOTE:
ALL WATER LINES ARE
8" UNLESS OTHERWISE
NOTED.

LEGEND:
SEWER LINE ———— MANHOLE ○
WATER MAIN ————

SCALE: 1" = 40'

Michael Baker Corp.
1000 North 17th Street
Birmingham, AL 35203
205.988.4400
www.michaelbaker.com

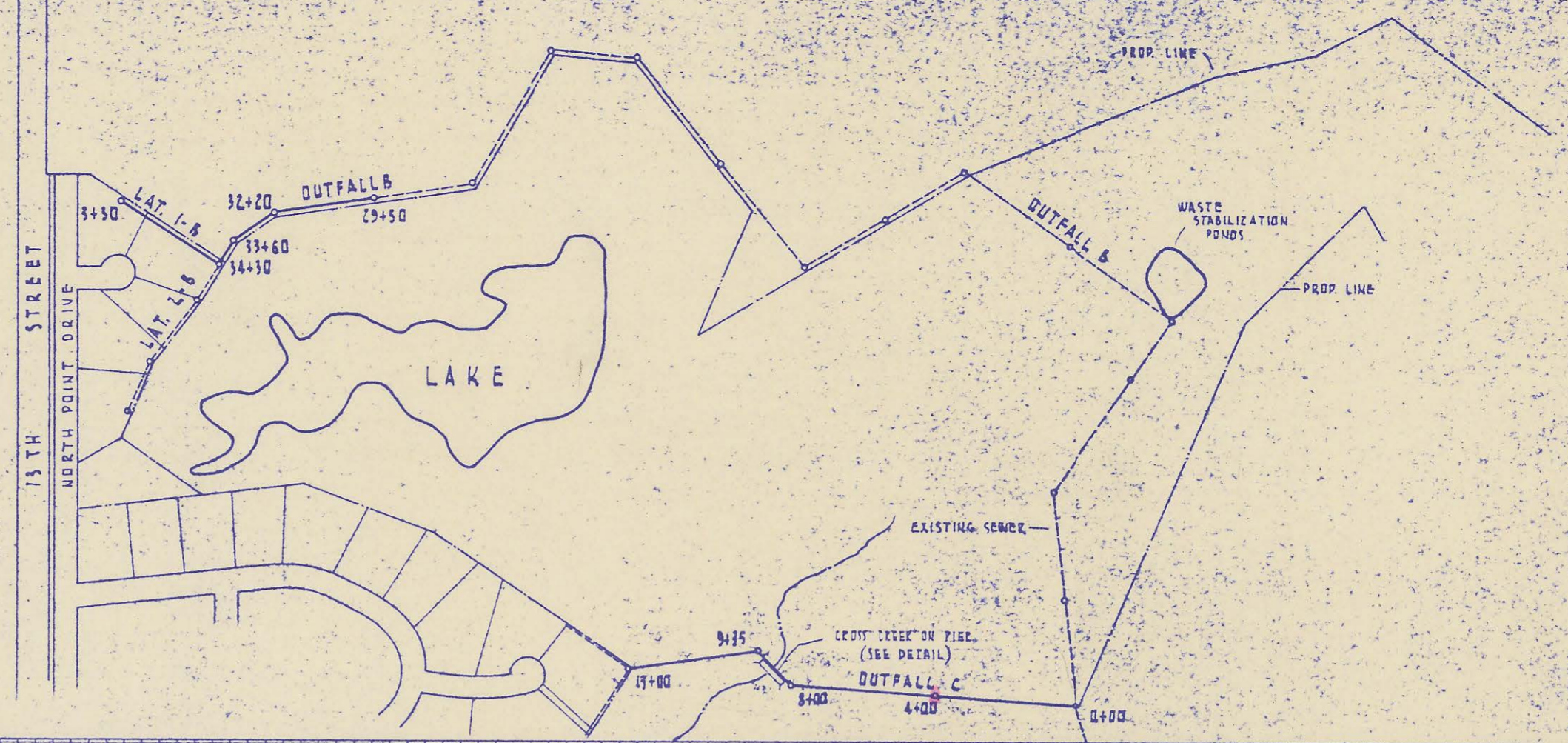

SCALE: PLAN: 1"=100'
PROFILE: 1"=10'
HORIZ: 1"=100'
VERT: 1"=40'

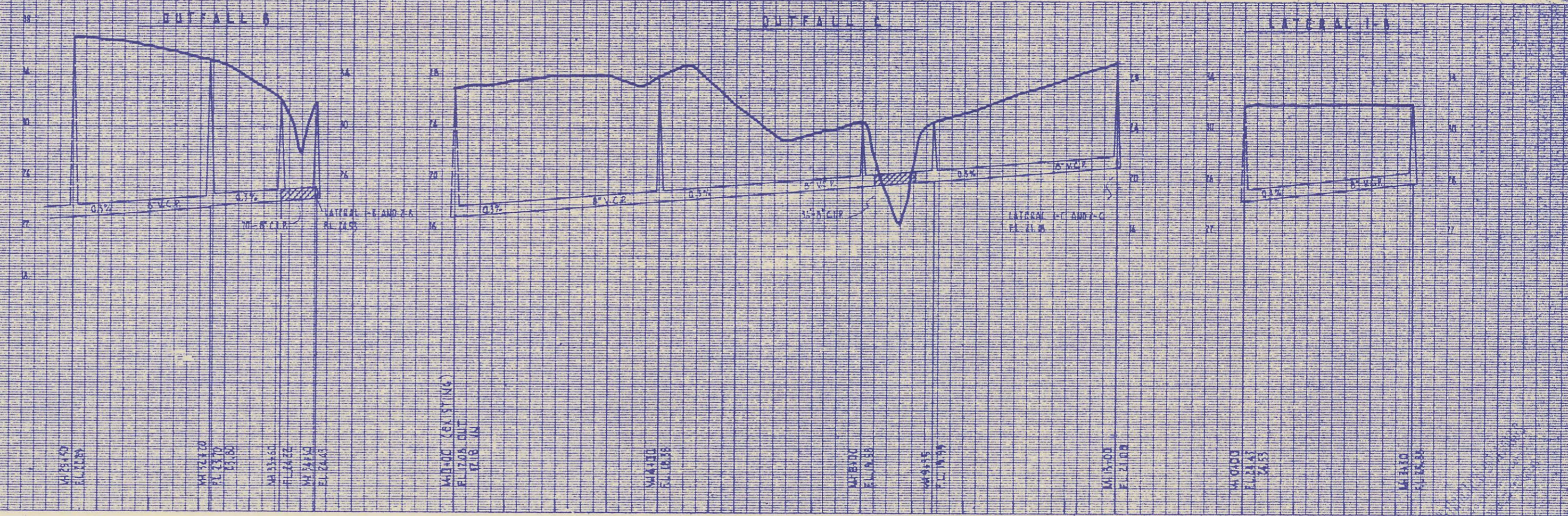

34 35 36 37 38 39 40 41 42 43 44 45 46 47 48 49 50 51 52 53 54 55 56 57 58 59 60 61 62 63 64 65 66 67 68 69 70 71 72 73 74 75 76 77 78 79 80 81 82 83 84 85 86 87 88 89 90 91 92 93 94 95 96 97 98 99 100

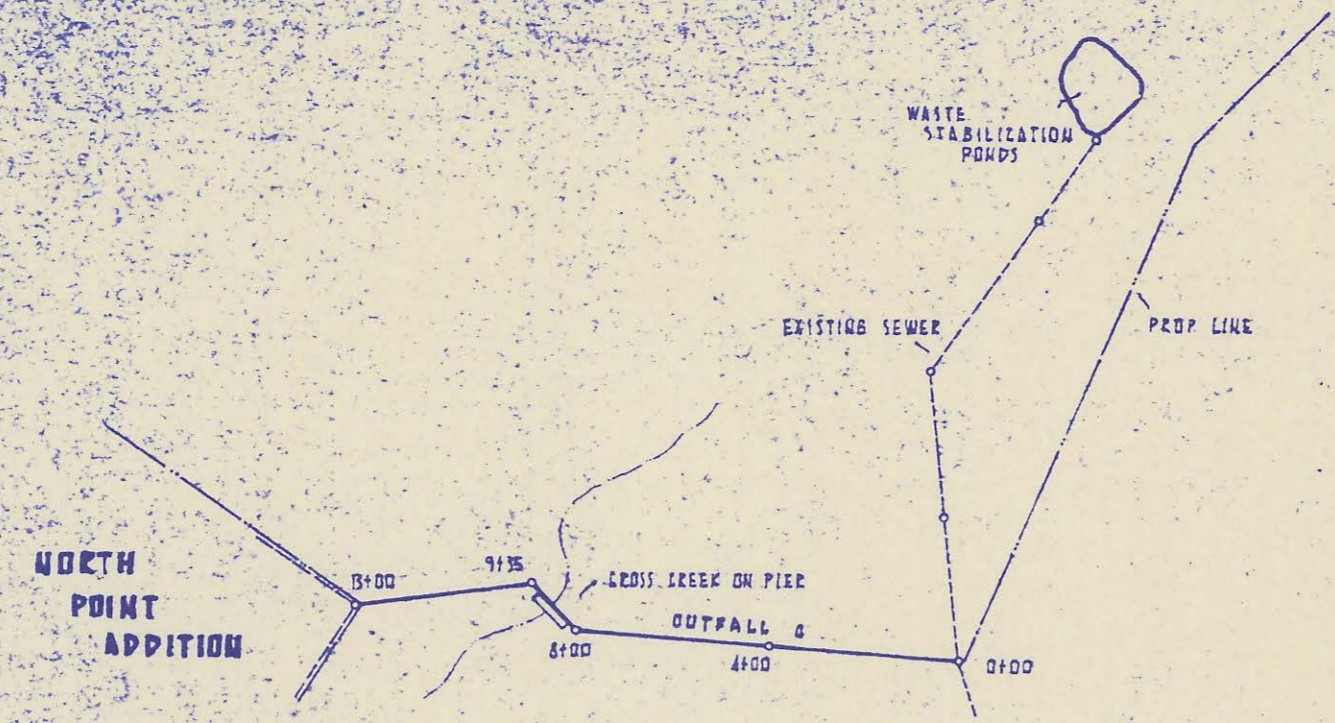

NORTH
 SCALE: PLAN: 1" = 200'
 PROFILE:
 HORIZ: 1" = 5'
 VERT: 1" = 4'

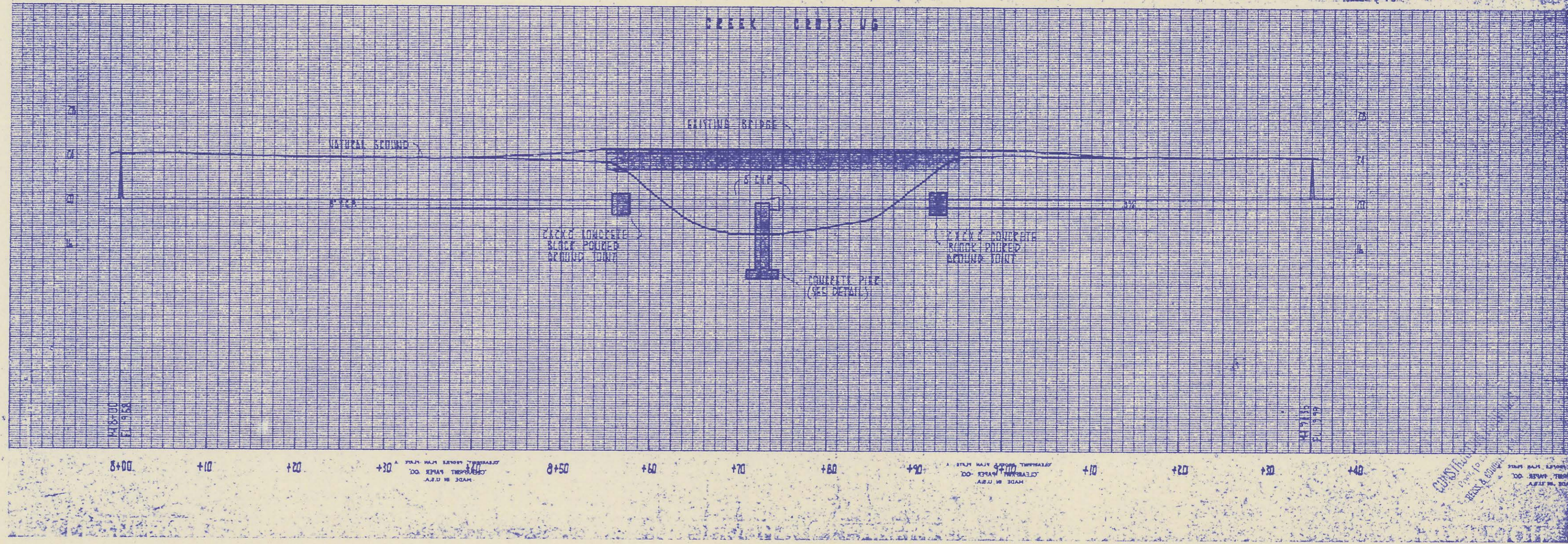
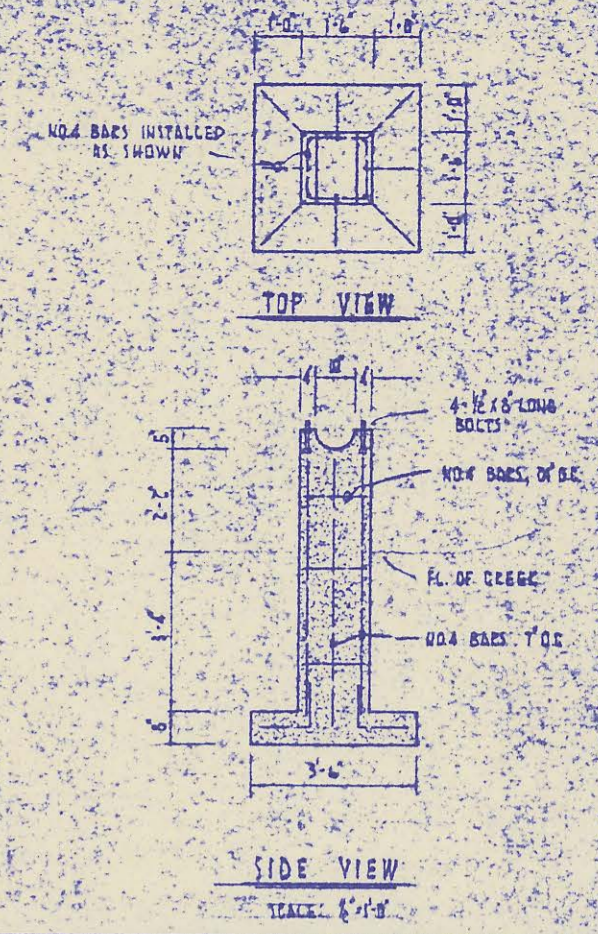
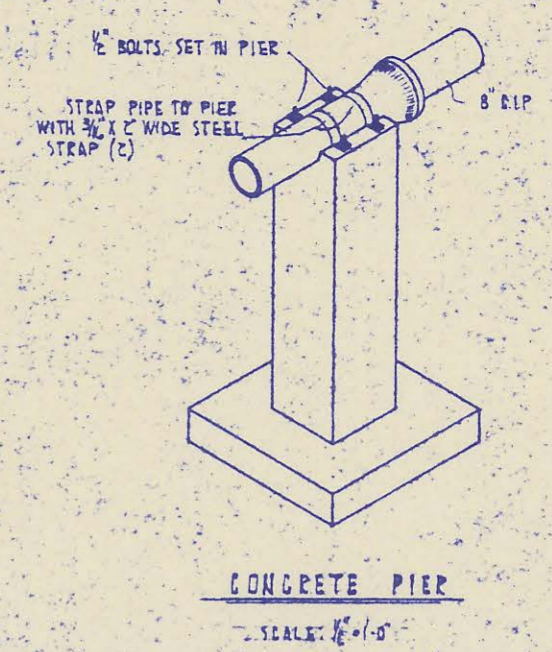

WESSMAN & GODDNESS ENGINEERS
 2160 E. DOUGLAS WICHITA, KANSAS

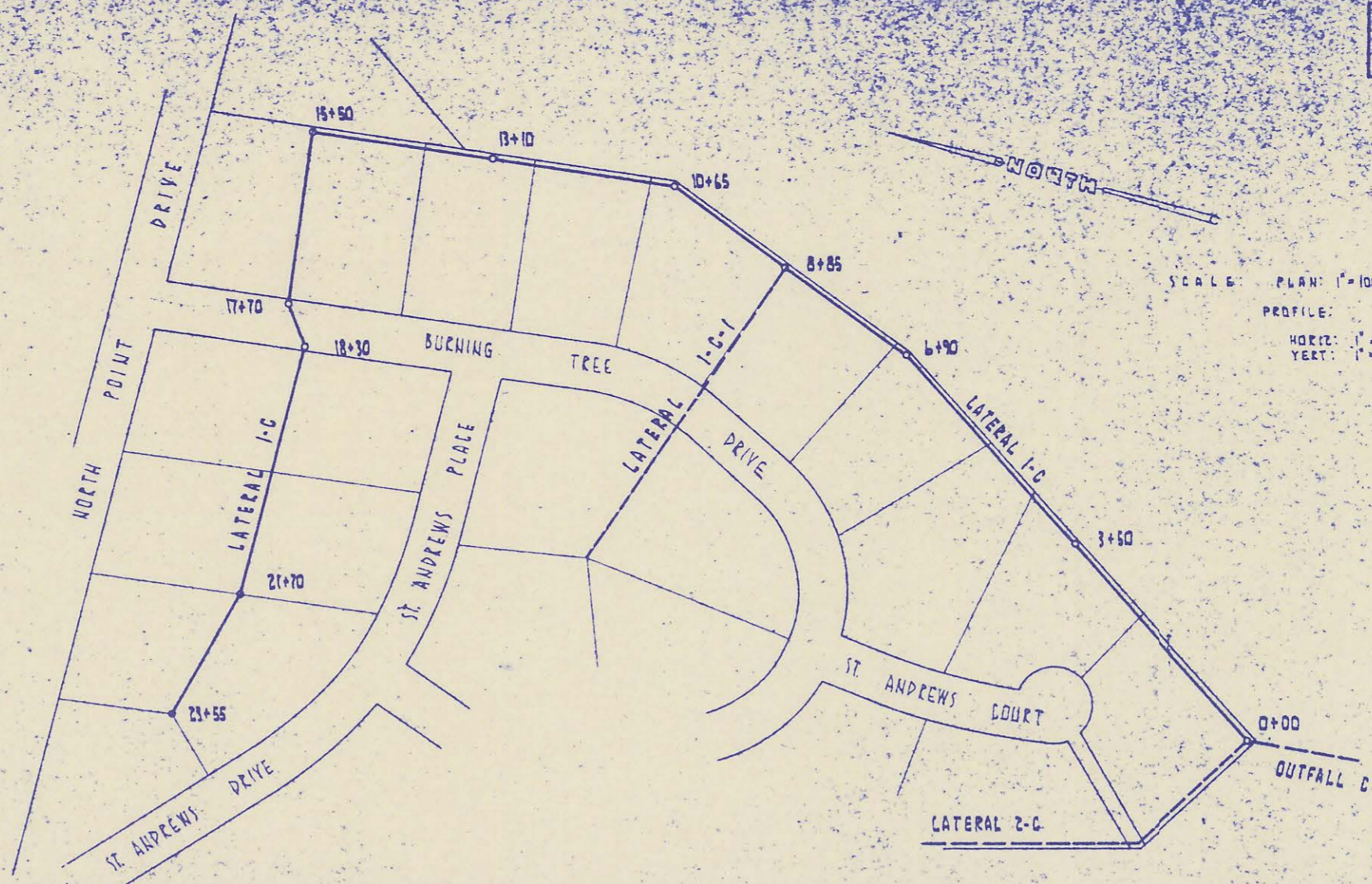

SCALE: PLAN: 1"=100'
 PROFILE:
 HORIZ: 1"=100'
 VERT: 1"=4'

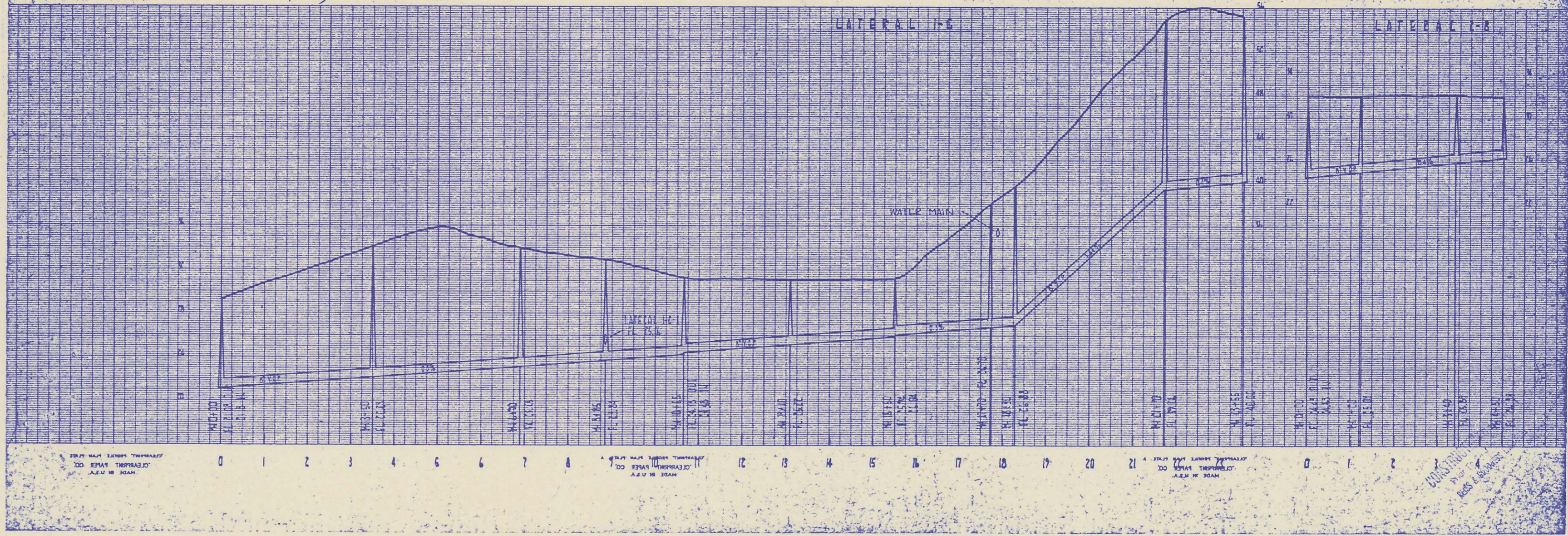
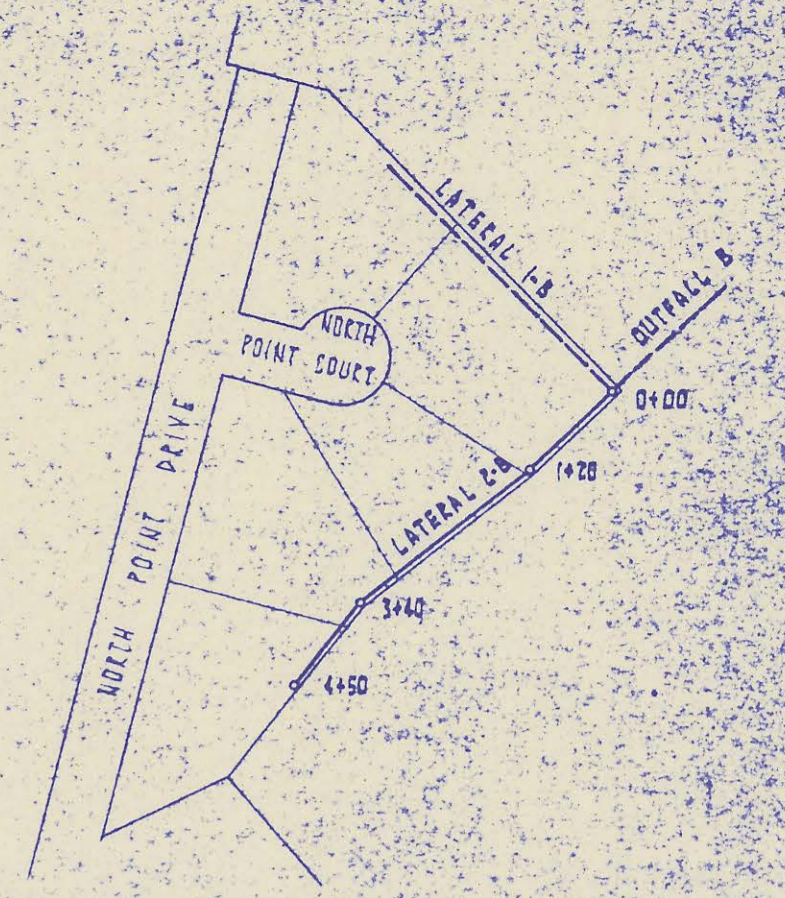

MADE IN NEW YORK
 LITTON PHOTO ENGRAVING CO.
 200 WEST 43RD STREET
 NEW YORK 36, N.Y.

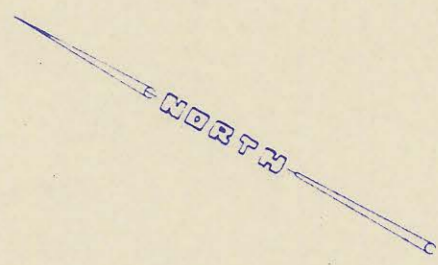
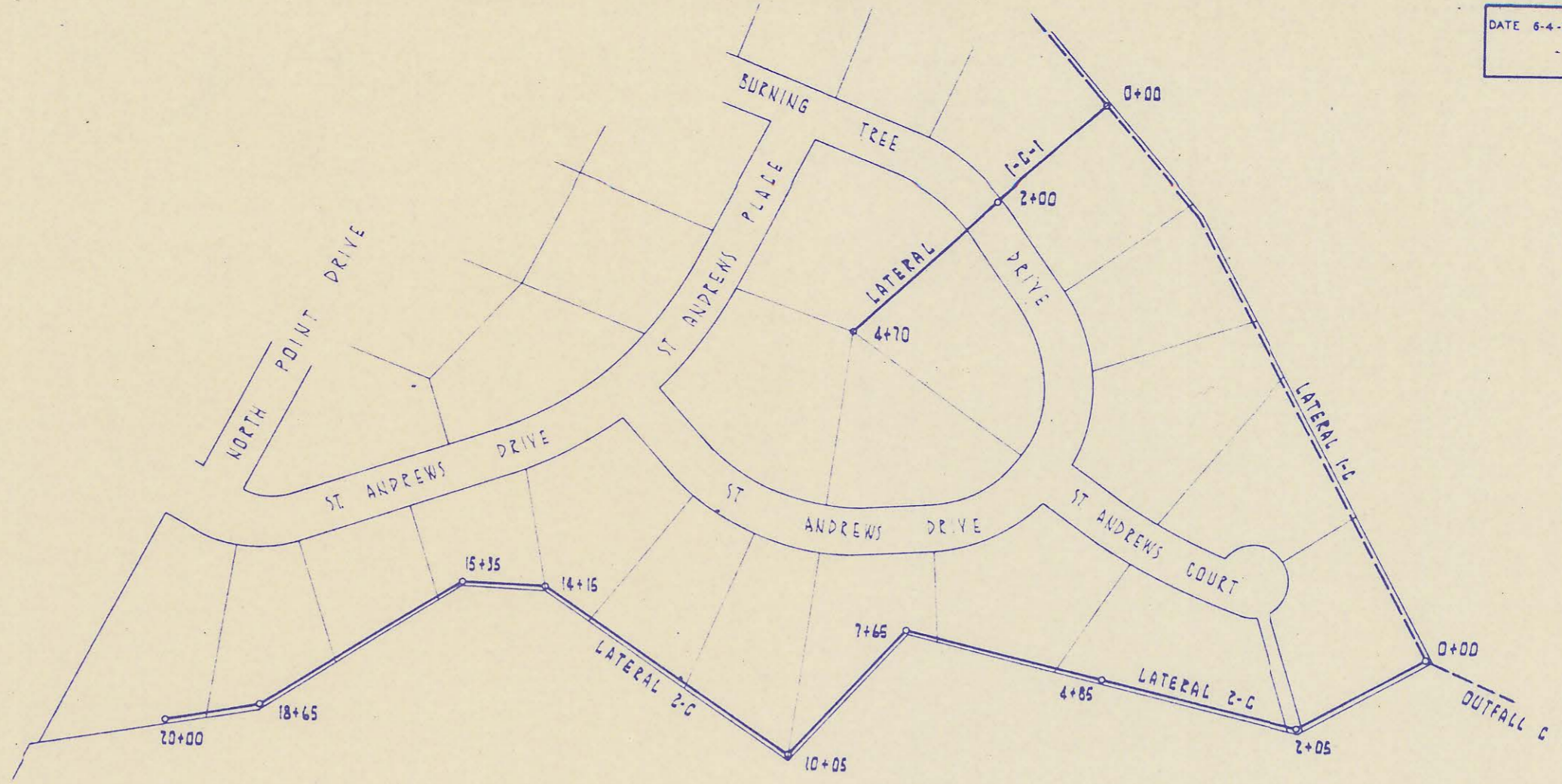

SCALE: PLAN 1"=100'
 PROFILE: HORIZ 1"=100'
 VERT 1"=4'

