

GENERAL NOTES:

- The Contractor shall comply with all applicable safety regulations. All construction shall be completed following current City Standard Specifications and Special Provisions.
- Contractor will be required to provide notice to utility companies a minimum of seventy-two (72) hours prior to any excavation, as follows:
Kansas One-Call 687-2470
The Contractor must notify the following in case of an emergency:
AT&T 1-800-246-8464
Black Hills Energy 1-800-694-8989
City of Wichita Water & Sewer 1-316-219-8921
City of Wichita Stormwater 1-316-268-4090
City of Wichita Traffic 1-316-268-4034
Cox Communications 1-888-249-3530
Kansas Gas Service 1-888-482-4950
Westar Energy 1-800-544-4857
- Utility service lines, poles, etc. are to be adjusted as necessary by others prior to construction unless the plans specifically call for their adjustment by the Contractor or unless the plans specifically identify a utility to be adjusted by its owner during construction. Existing utilities and their location, as shown on the plans, represent the best information obtainable for design. The Contractor will be required to work around existing utilities within the right-of-way which do not conflict with proposed construction.
- Rubble from the removal of miscellaneous structures and excess excavation which is to be wasted shall be disposed of on sites to be provided by the Contractor. These sites shall be approved by the Engineer as to suitability, appearance and site location. Locations, in the opinion of the Engineer, that will leave an unsightly appearance will not be approved. All disposal sites must be approved by the Kansas Department of Health and Environment. Material either stockpiled or disposed of in a flood plain will require a Kansas State Board of Agriculture permit. Any material dumped in waters of the United States or wetlands is subject to U.S. Corps. of Engineers permitting regulations. Any material buried or stockpiled beyond approved construction limits will require additional archaeological investigations unless buried in a previously approved borrow location.
- Trees and shrubs in public right-of-way which are in direct conflict with proposed new construction shall be removed by the Contractor with the City Engineer's approval. Trees and shrubs which are not in direct conflict with proposed new construction shall be saved and protected from damage.
- The Contractor shall give all property owners and/or tenants of developed property abutting the construction of this project a minimum of ten (10) days notice prior to start of construction.
- The Contractor shall be responsible for preserving property irons. The Contractor will be required to re-establish any property irons which are damaged or destroyed by his construction operations. Such irons shall be re-established by a licensed land surveyor in accordance with state laws.
- The Engineering Division shall field locate water valves one time during construction when requested by the Contractor. It shall be the Contractor's responsibility to preserve such field locations during the construction process. Water valves, valve boxes or fire hydrants damaged during construction shall be repaired by Contractor at his own expense. Valve boxes and water meters within the project limits shall be adjusted to match final grades by the contractor.
- The Contractor shall notify the inspecting engineer and Tom Mason at 316-268-4574 with the City of Wichita with the anticipated construction start date and notify them of project completion. Staking and inspection for this project will be the responsibility of the Contractor.
- If traffic will be impacted by construction, a traffic control plan must be submitted and approved by the City Traffic Engineer at traffic@wichita.gov before construction can begin. The Contractor shall be responsible for all traffic control measures to facilitate construction. All construction zone markings and signage shall conform to the latest version of the Manual on Uniform Traffic Control Devices (MUTCD) as published by the US Dept. of Transportation, Federal Highway Administration. All costs associated with construction markings and signage shall be the Contractor's responsibility.
- All elevations shown are NAVD 88.
- All areas disturbed during construction that will not be under proposed pavement shall be restored to match existing conditions.
- Any sidewalk, drive approach, or street pavement removed to construct project must have a pavement cut permit and be replaced by the City contractor. Permits can be obtained by calling 316-268-4501 or 316-268-4480.
- City maintenance of storm sewer ends at the last structure in the easement or right-of-way.
- A portion of excess excavated material shall be mounded around manholes which extend more than one (1) foot above the existing ground. Such mound shall be constructed with new development a six (6) foot diameter flat top with 4 to 1 side slopes down to the original ground. The elevation of the flat top of the mound shall be 0.4 foot below the top of the manhole.
- Geotechnical report available upon request.
- Contractor shall limit the extent of trench openings overnight and weekends to less than 50 feet.
- The inspecting firm shall submit to the City Stormwater Maintenance Division a digital copy of the CCTV inspection of the conduits and structures following construction. The digital file formation shall be compatible with the City input template. A copy of the template is available upon request at 316-268-4090.
- The Contractor shall protect from damage and support existing utilities through construction as approved by the utility owner and the Engineer at the contractor's expense.

Benchmarks:

BM #1
"x" Cut in Top of Curb on East Side of N Ridge Road
Elevation= 1335.37 NAVD 88
BM#2:
"x" Cut in Top of Curb on South Side of Palmetto Street
Elevation= 1334.78 NAVD 88

STORM SEWER IMPROVEMENTS

to serve

ESTANCIA

Lot 7 Block 1 Estancia Commercial Addition

Except The East 127' Thereof

3950 N RIDGE RD

CITY OF WICHITA, KANSAS

Gary Janzen, P.E. City Engineer

Project Number

2020 - 654 PPD (133119)

Date: 2021-04-21
Inspector: A. Thompson/M. Collins
Design/Inspecting Firm: KEMILLER Engineering / Kaw Valley Engineering, Inc.
Contractor: Icon Structures
Subcontractor: Sooter Excavating LLC
Built in general conformance to construction plans, except where noted on plans.

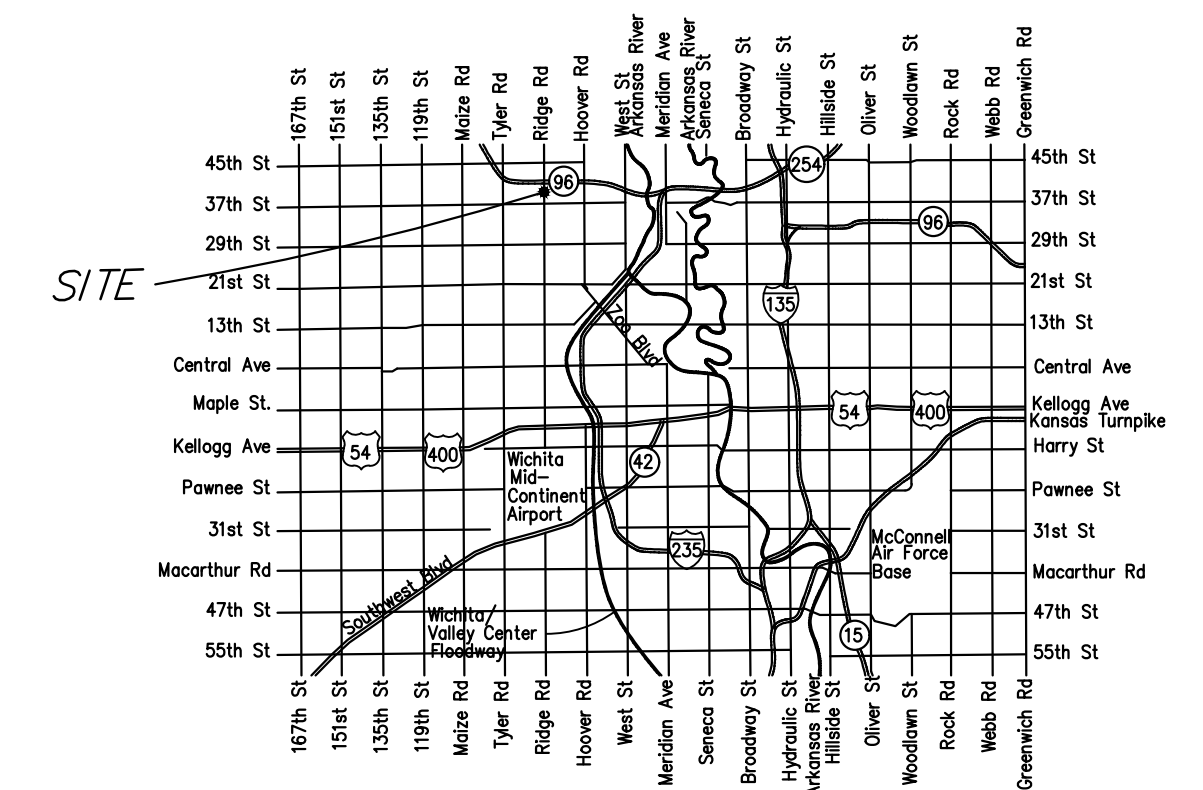

Vicinity Map

Sheet Index

1.0	Title Sheet
2.0	Control Plan
3.0	Plan and Profile - Line 1
4.1	Curb Inlet Details
5.0	Erosion Control Plan
5.1-5.5	Erosion Control BMP Details
6.0	ERU Plan
7.0	Plat

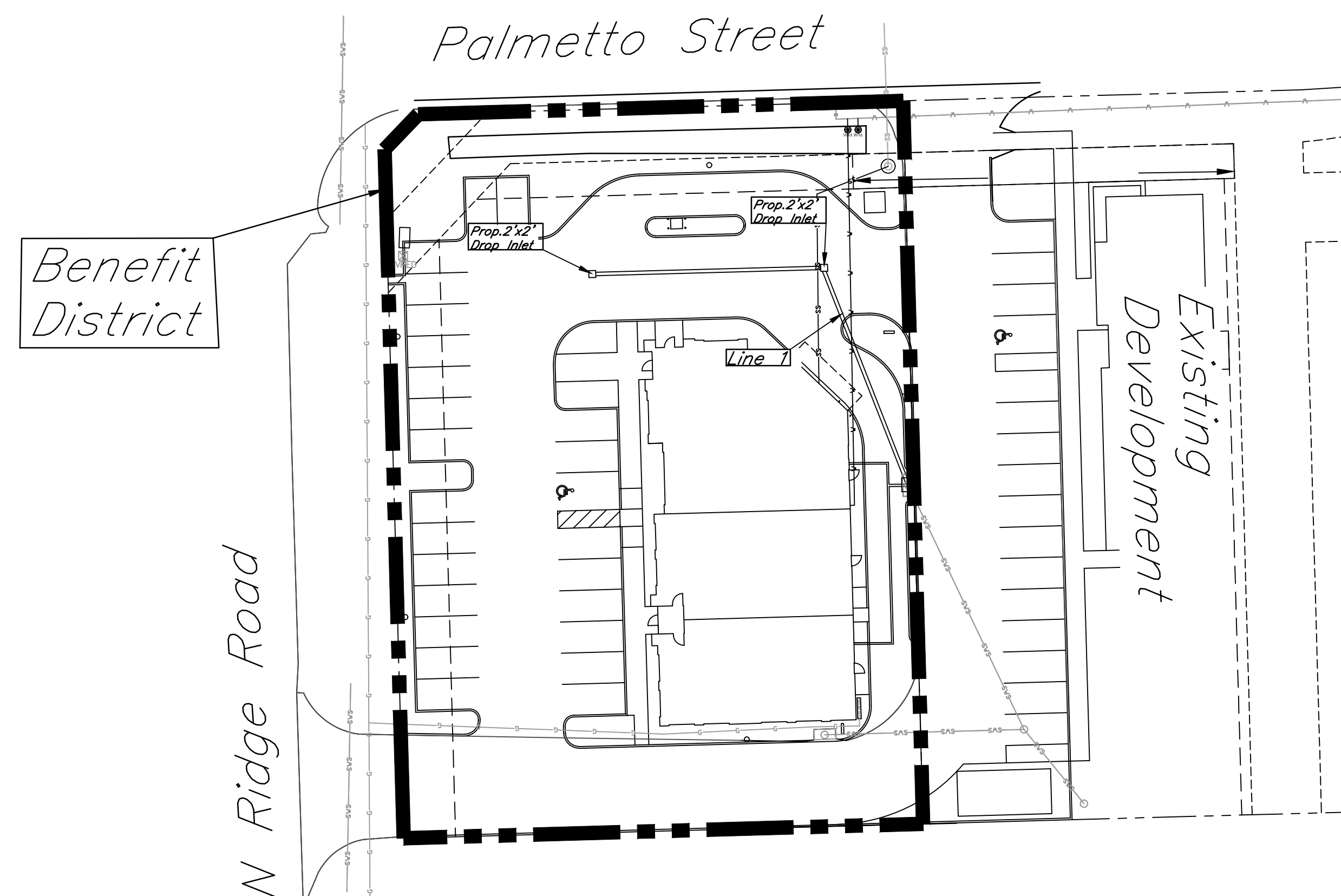

Stormwater Certification
 New Development Redevelopment (Circle One)
 Stormwater Permit # SWO 2020-0055
 NOI Permit # N/A

These construction plans were prepared in accordance with the current Stormwater management Regulations as set forth in the City of Wichita's Stormwater Management Ordinance 16.32 and the policies/guidelines presented in the Wichita/Sedgwick County Stormwater Manual.

Site Area (Acres) = 0.72
 Disturbed Area (Acres) = 0.62
 Water Quality Treatment: COW Off-Site BMP Program
 Downstream Channel Protection: N/A
 Detention: N/A
 The BMP used for this development is COW Off-Site BMP Program

APPROVED AS NOTED
 BY WICHITA PUBLIC WORKS ENGINEERING
 AND STORMWATER DIVISION

Engineering approved by Shawn Mellies on this day
 the 15th of December, 2020

Stormwater approved by Joe Hickie on this day
 the 15th of December, 2020

NOTE TO CONTRACTORS

Inspection and testing for this project is to be provided by a Licensed Consulting Engineering Firm under contract with the Owner/Developer. Said inspection to be in accordance with the City of Wichita standard construction engineering practices and certified by a Licensed Professional Engineer in the state of Kansas. No work shall be performed the Contractor without such inspection nor shall any work be commenced without written authorization by City Engineering. All Construction and Materials shall comply with the current City of Wichita Specifications and Standards and Special Provisions. (on file and available at Wichita.gov).

An approved copy of these plans signed by City staff are required on-site.



THIS SHEET HAS BEEN SHOWN, SEALED AND DATED DIGITALLY

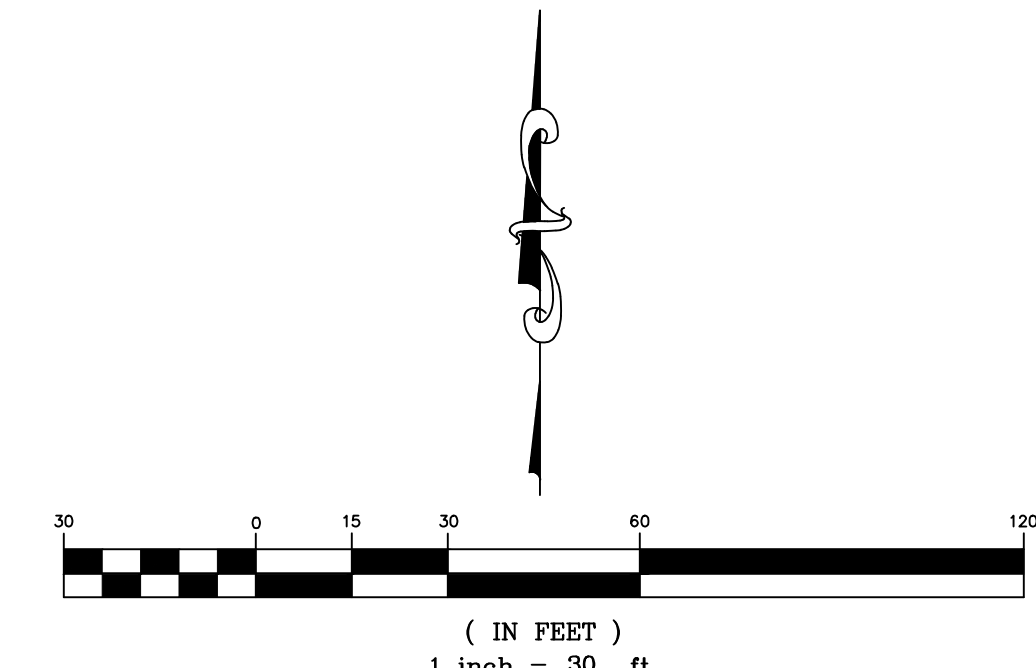

October 2020

KEMILLER
 ENGINEERING PA
 117 E. Lewis, Wichita, KS 67202 (316)264-0242

Control Points			
Point #	Northing	Easting	Desc.
1	1710480.63	1622789.08	Control Point
2	1710679.30	1622783.62	Control Point
3	1710689.52	1622793.27	Control Point
4	1710693.40	1622933.25	Control Point
5	1710696.59	1623048.30	Control Point
6	1710697.30	1623060.18	Control Point
7	1710488.22	1623065.98	Control Point
8	1710484.74	1622939.03	Control Point

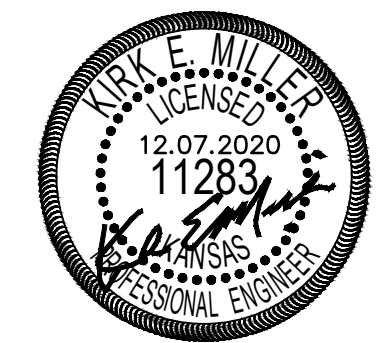
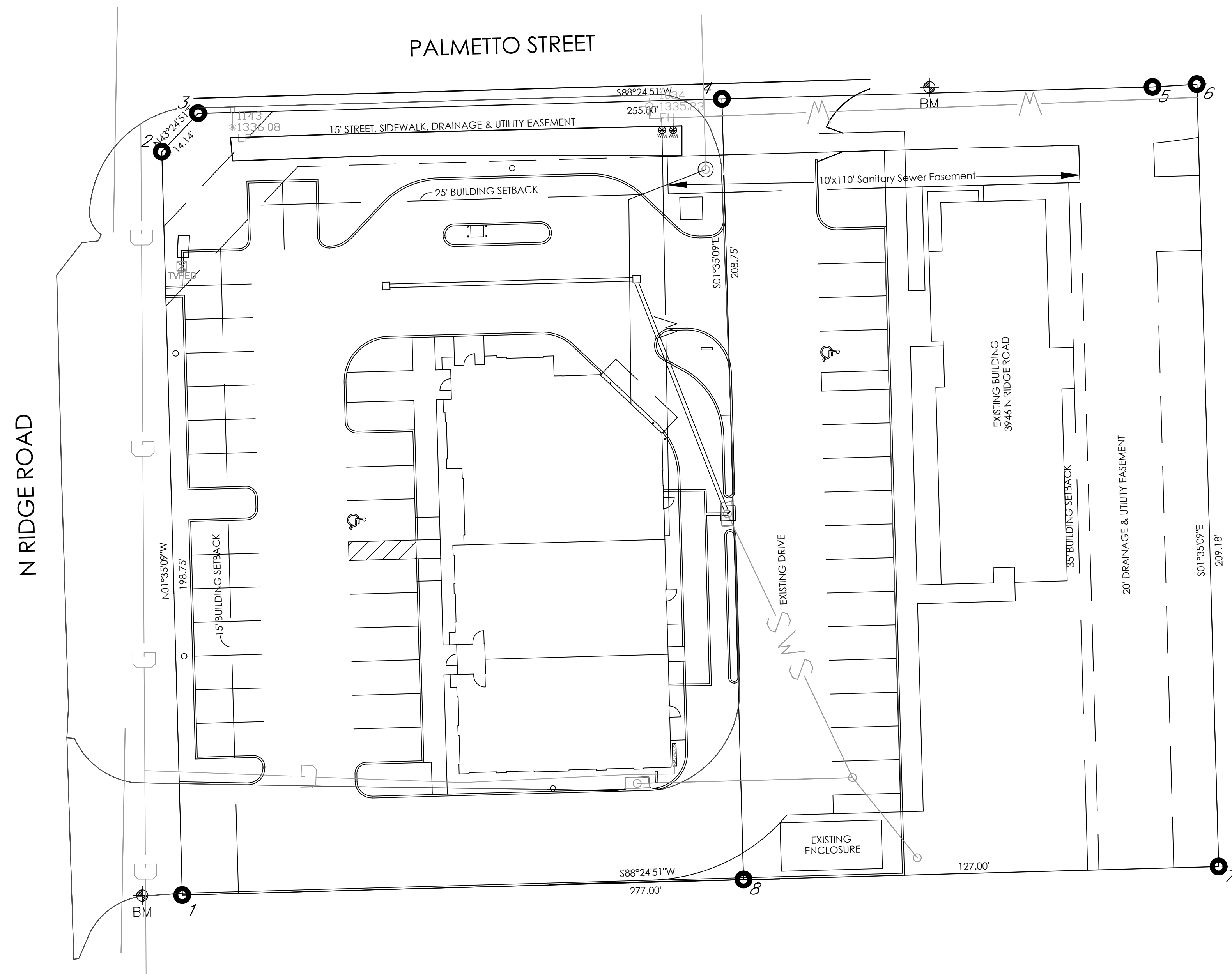

THIS SHEET HAS BEEN
SIGNED, SEALED AND
DATED DIGITALLY



HORIZONTAL SCALE
(IN FEET)
1 inch = 20 ft.

Estancia
Control Map/Plan Sheet
Wichita, Kansas

 117 E. Lewis, Wichita, KS 67202 (316)264-0242	PROJECT NUMBER 654 PPD (133119)			SHEET 2.0
	KEM NO. 20099 DESIGN KM	FILE DATE 10/2020 DRAWN PG REVISED	DATE 10/2020 REVISED	

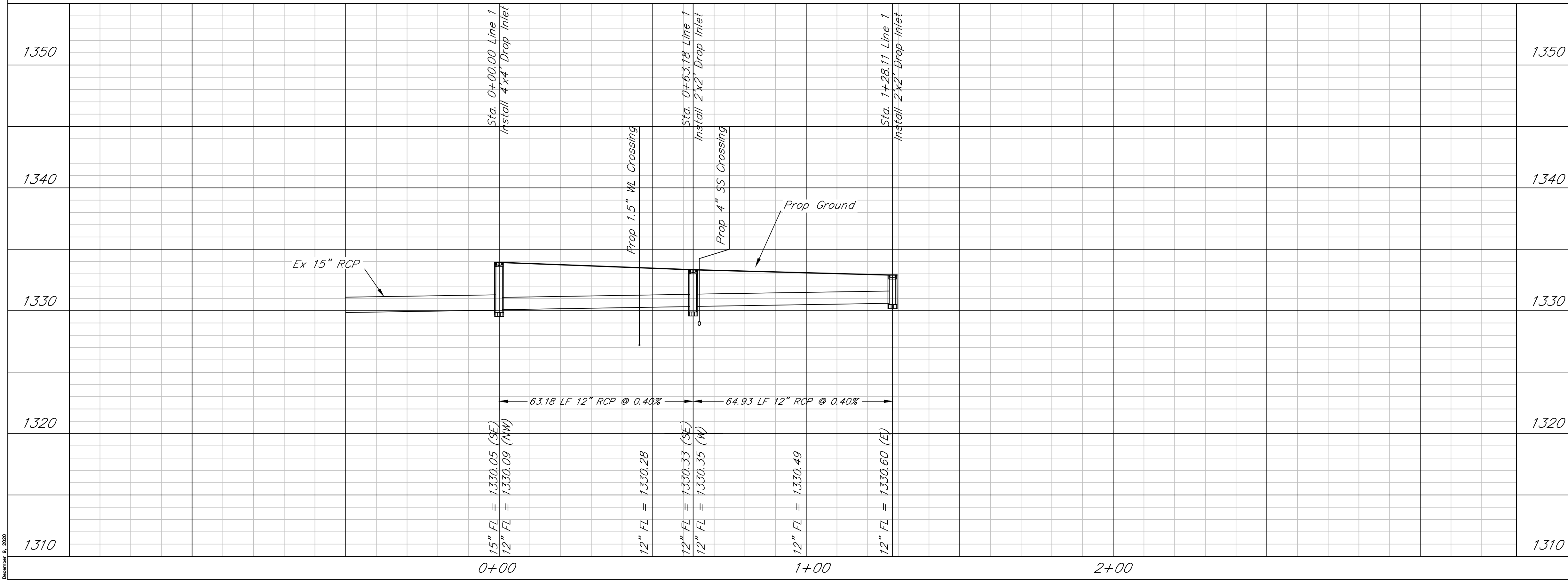
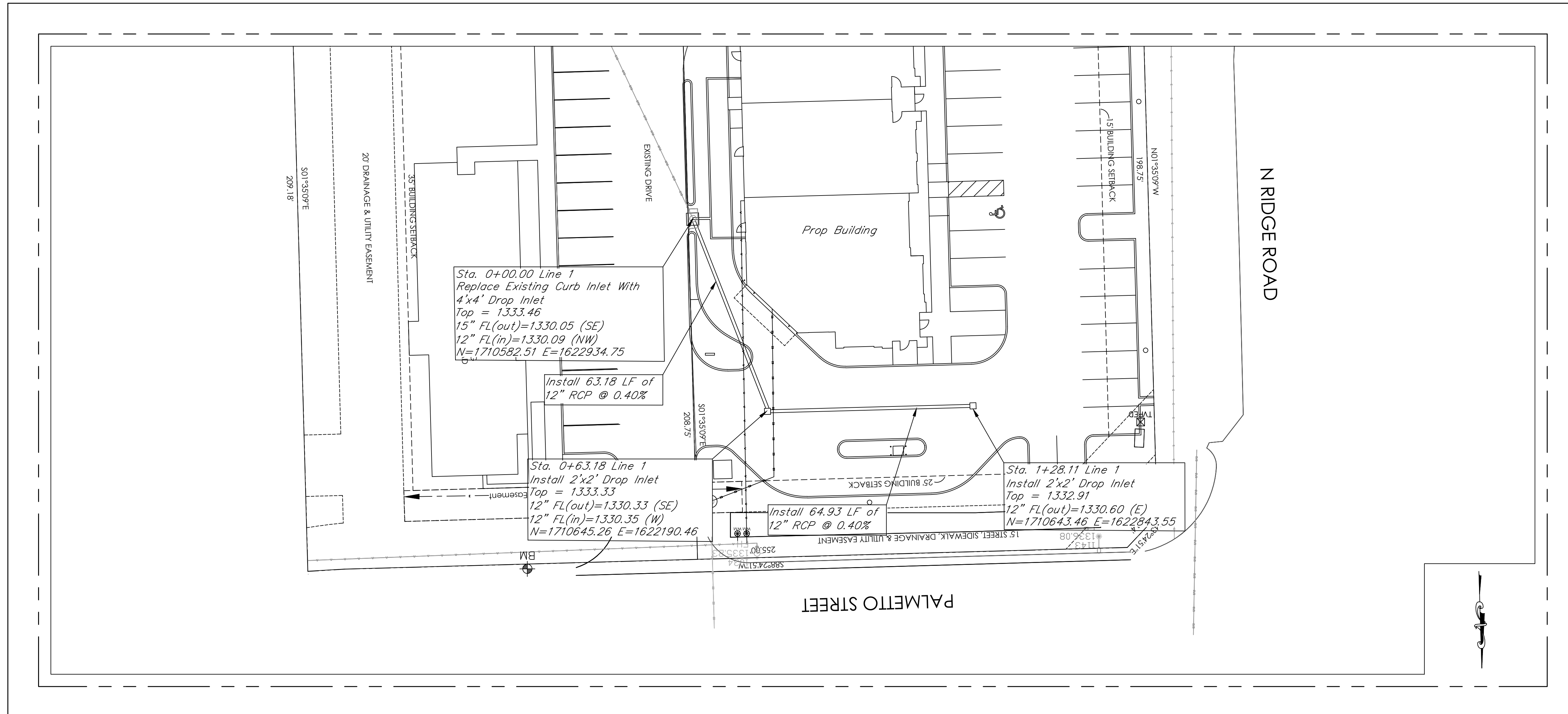

THIS SHEET HAS BEEN SIGNED, SEALED AND DATED DIGITALLY

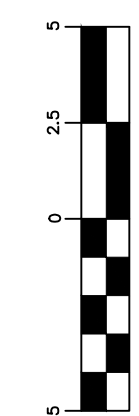

VERTICAL SCALE (IN FEET)
1 inch = 5 ft.



HORIZONTAL SCALE (IN FEET)
1 inch = 20 ft.

Estancia
SWS Plan and Profile - Line 1
Wichita, Kansas

 117 E. Lewis, Wichita, KS 67202 (316)264-0242	PROJECT NUMBER 654 PPD (133119)			SHEET 3.0
	KEM NO. 20099	FILE	DATE 10/2020	
DESIGN KM	DRAWN PG	REVISED		

December 8, 2020

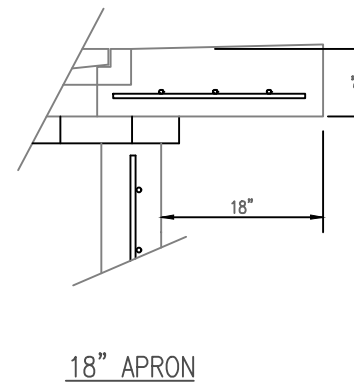
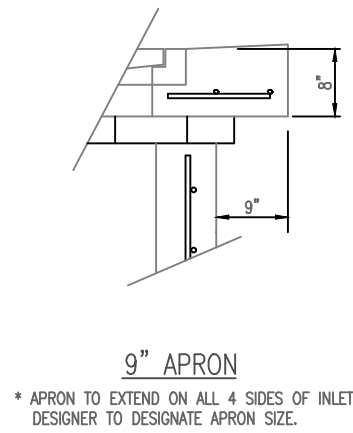
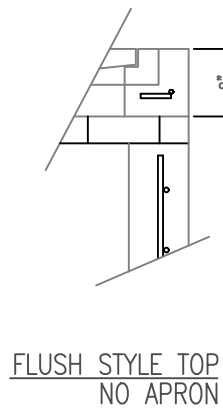
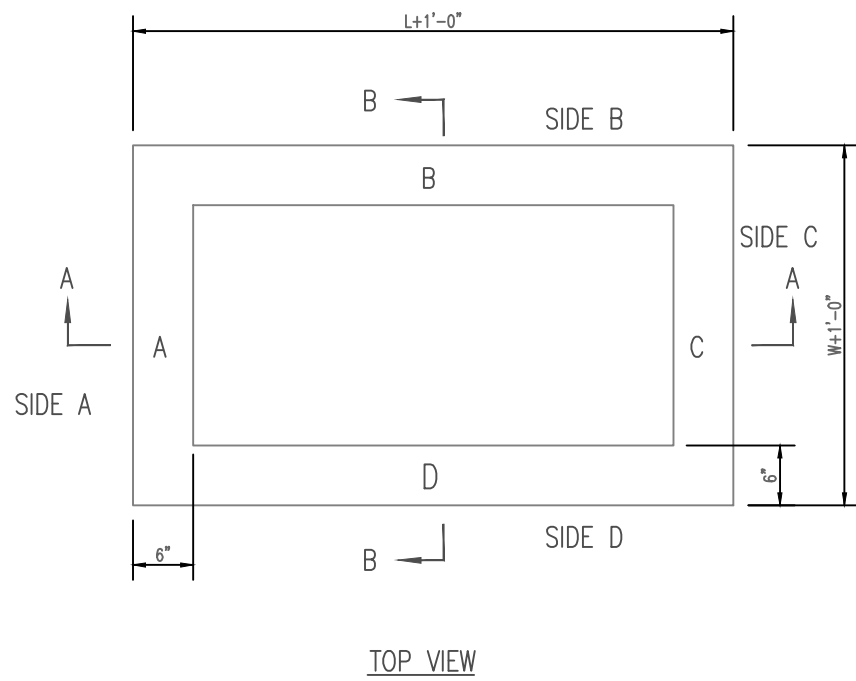

* APRON TO EXTEND ON ALL 4 SIDES OF INLET.
DESIGNER TO DESIGNATE APRON SIZE.

W=2' and L=2' for SINGLE DROP INLET
W=2' and L=4' for DOUBLE DROP INLET

The structure(s) on this detail sheet are designed for HS-20 loading at these specific dimensions only.
If larger dimensions are required, the ENGINEER shall provide a project specific structure design for approval by the City Engineer's office.

GENERAL NOTES

1. GRATE FRAME TO BE INSTALLED ON THIN MORTAR CUSHION TO INSURE FULL SUPPORT ALONG BRICK. CONCRETE USED FOR INLET CONSTRUCTION SHALL CONFORM TO CITY OF WICHITA SPECIFICATIONS FOR CONCRETE PAVEMENT MIX.
2. INLET INVERT SHALL BE SHAPED WITH 8 SACK SAND MIX CONCRETE TO CREATE FLOW CHANNELS AND TO INCREASE HYDRAULIC EFFICIENCY SUCH THAT THE INLET WILL BE SELF CLEANING BETWEEN ALL INLET AND/OR OUTLET PIPES.
3. THE ENDS OF ALL PIPES INSTALLED IN INLETS SHALL BE CUT OFF FLUSH WITH THE INSIDE FACE OF THE INLET WALL.
4. INLET FRAME AND GRATE TO BE DEETER #2433, EJIW #5391-Z1 OR APPROVED EQUAL FOR 2'x2' SINGLE DROP INLET AND DEETER #2434, EJIW #5391 Z3 OR APPROVED EQUAL FOR 2'x4' DOUBLE DROP INLET.
5. CONTRACTOR SHALL REMOVE LIFTING HOOKS AFTER INSTALLATION. RECESSES IN INLET WALL SHALL BE GROUTED FLUSH TO THE INLET WALL WITH HYDRAULIC CEMENT AFTER THE INLET IS IN PLACE. LIFTING HOLES THRU THE INLET WALL WILL NOT BE ACCEPTED.

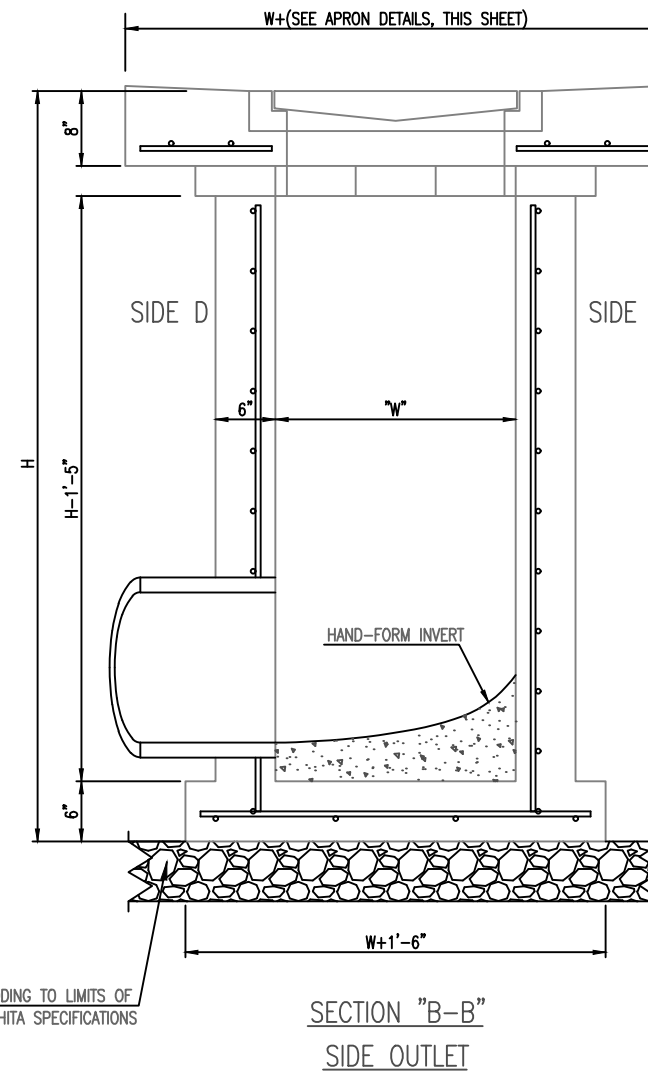
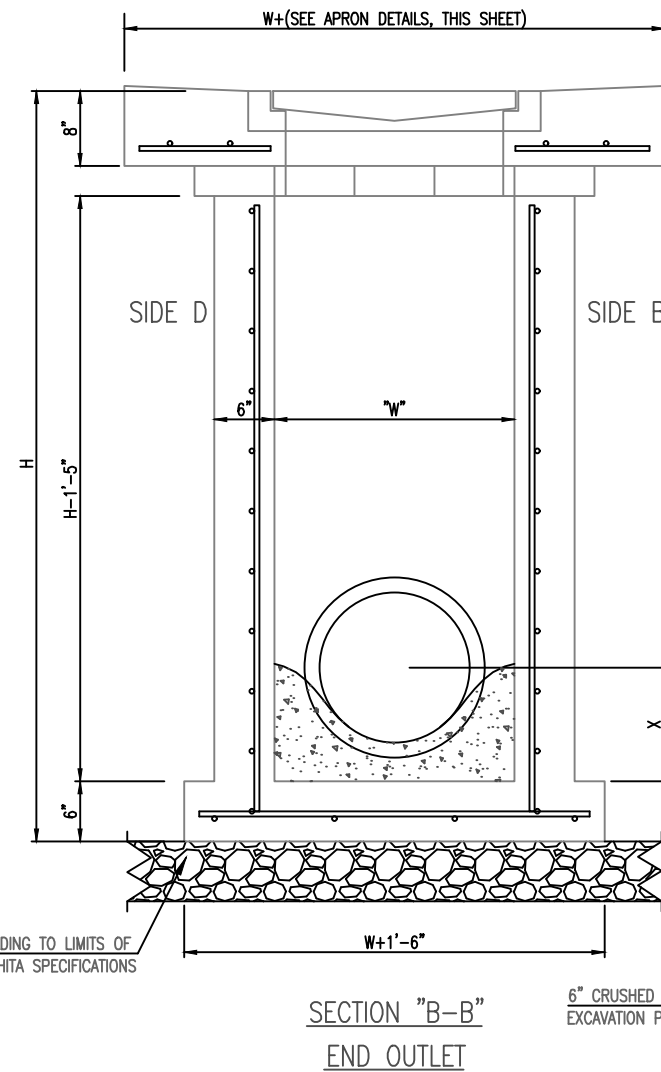
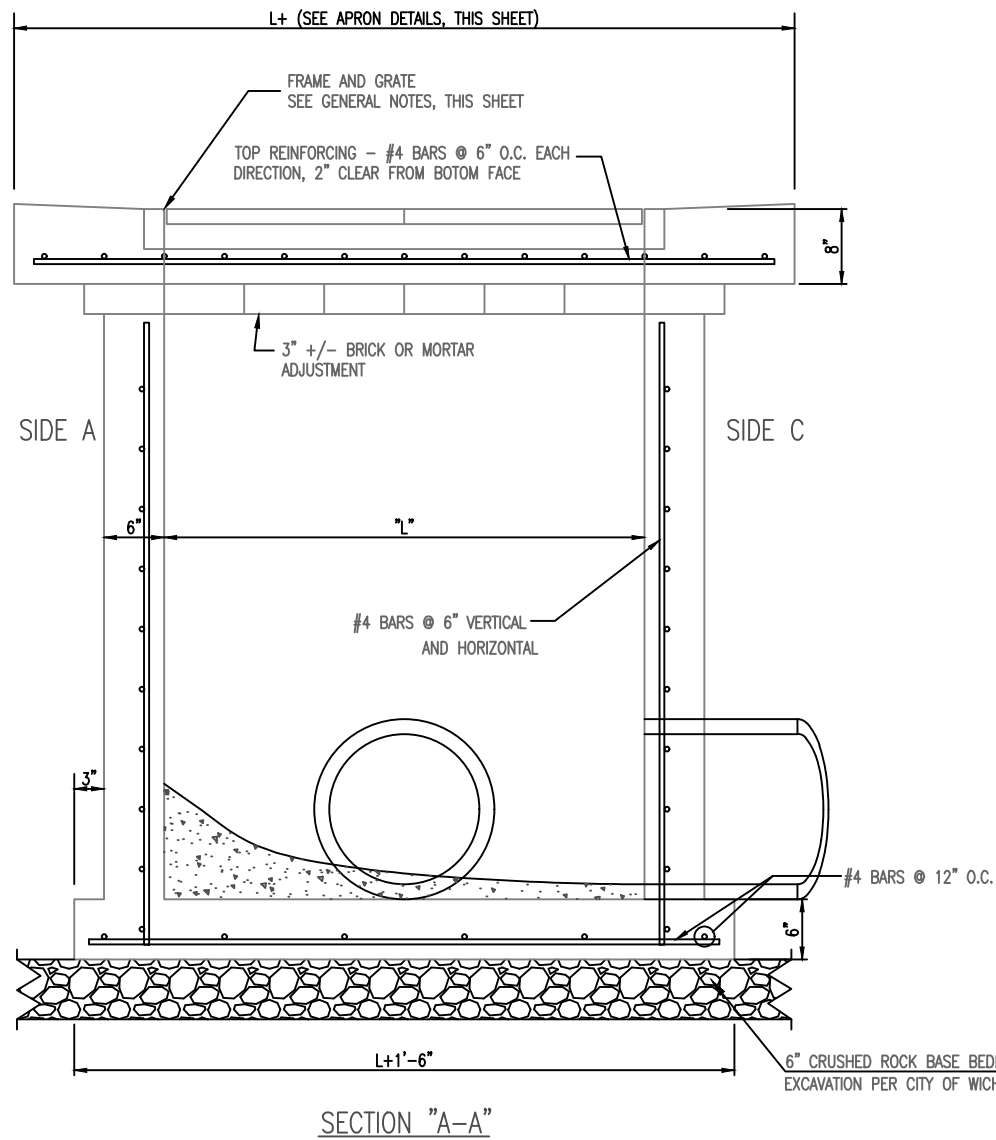

REVISED: MARCH 2015

SINGLE/DOUBLE DROP INLET		
CITY ENGINEER GARY JANZEN, P.E.		
PROJECT NUMBER	OCA NUMBER	DATE
CITY ENGINEER'S OFFICE CITY HALL - SEVENTH FLOOR 455 NORTH MAIN STREET WICHITA, KANSAS 67202-1620 (316) 268-4501		SHEET 4.1

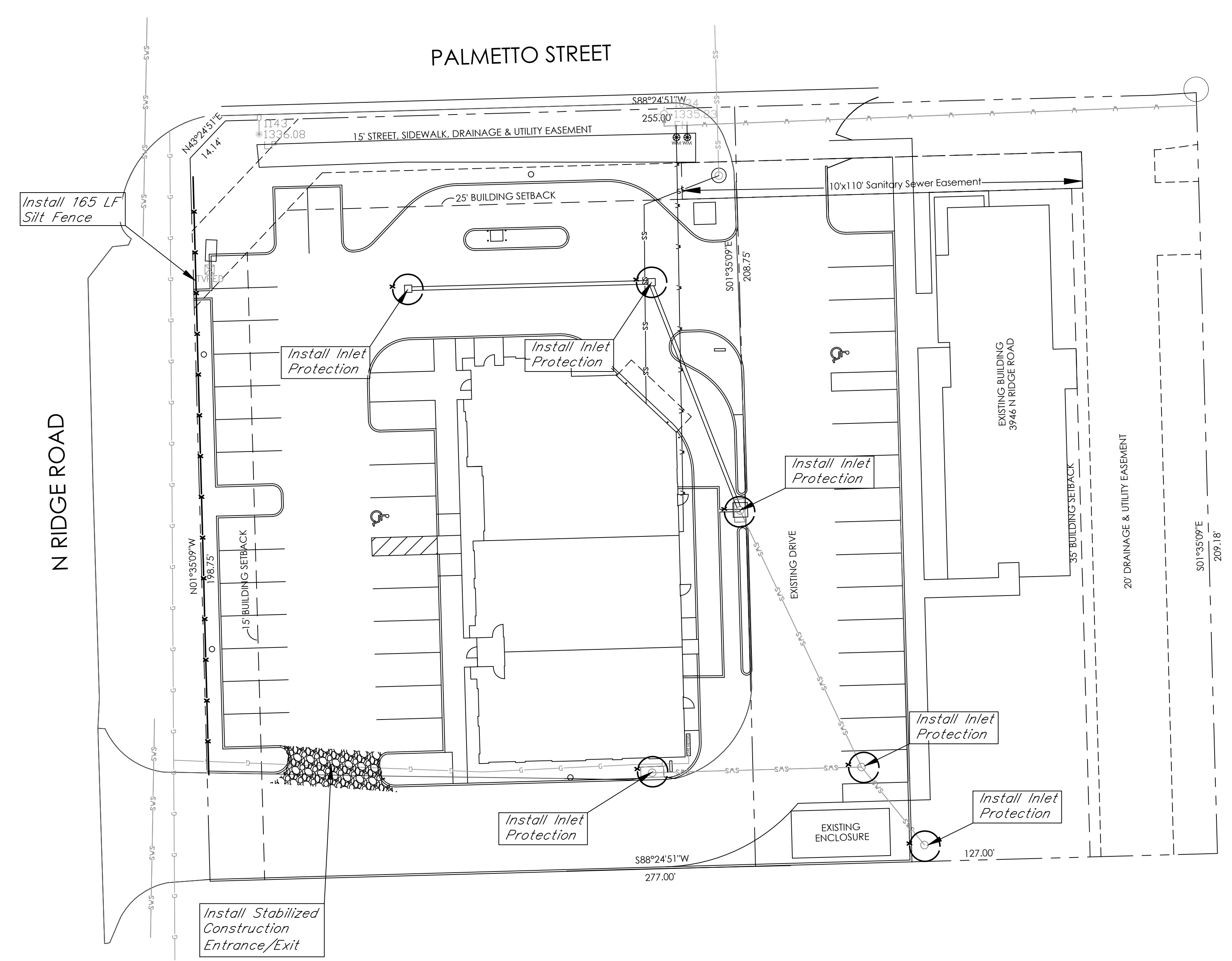

- General Notes:**
1. The BMP's shown on this sheet are considered minimum standards. Whenever sediment enters the streets, storm sewers, ditches, or ponds, contractor will install additional BMP's, as needed, to correct the problem.
 2. The soil erosion BMP's shown hereon must be in place at all times during construction until such time as the site is re-established with paving or grass.
 3. Back of curb protection can include hay bale, silt fence, Curlex barrier, or approved alternate as shown on BMP standard details. This BMP must remain in place until the area between the curb and right-of-way line has been permanently stabilized.
 4. The General Contractor is responsible for the installation and maintenance per the prevention maintenance plan.
 5. Concrete trucks will be permitted to wash out only at approved locations, then maintain and clean up as conditions require, by contractor. No hazardous materials are expected to be encountered. Any spills (diesel, fuel, oil, etc.) will be cleaned up and removed immediately. Portable toilets will be supplied and maintained at various sites along the project. Disposal of sewage will be handled by a contracting firm specializing in this activity.
 6. The above mentioned storm water prevention methods will be monitored daily and maintained as required. A weekly erosion control log will be posted in the job trailer onsite, and updated weekly. Site inspections are required within 24 hours after a precipitation event of 0.5" or greater.
 7. Stabilize disturbed areas within 14 days after soil disturbing activities cease. Stabilize with mulch or similarly effective BMP's, in addition to seeding.

- LEGEND:**
- Flow Direction
 - Inlet Protection - to be provided at all inlets subject to silt laden runoff.
 - Ditch Check
 - Temporary Seeding and Matting.
 - Silt Fence or Hay Bale Barrier - to be installed along property lines where runoff from construction site can run onto other properties.
 - Stabilized Construction Entrance - to be used at all locations where vehicles or equipment enter or exit property.
 - Back of Curb Protection - to be installed whenever curb is backfilled to less than 3 inches from top and disturbed earth exists adjacent thereto. (See City Standard Details.)

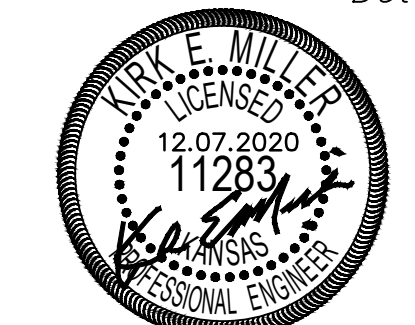

THIS SHEET HAS BEEN SIGNED, SEALED AND DATED DIGITALLY

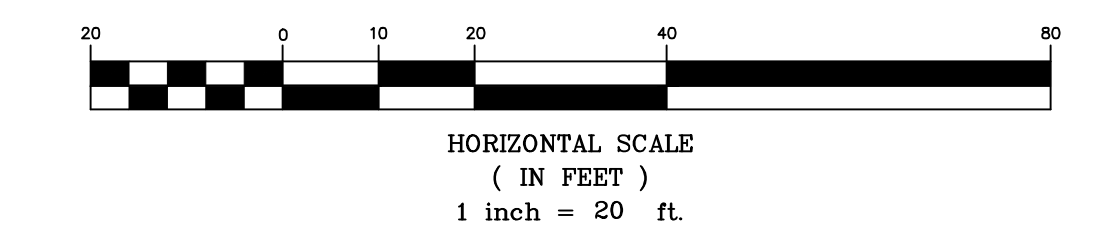

Estancia
Erosion Control Plan
 Wichita, Kansas

	PROJECT NUMBER 654 PPD (133119)			SHEET 5.0
	KEM NO. 20099	FILE	DATE 10/2020	
117 E. Lewis, Wichita, KS 67202 (316)264-0242	DESIGN KM	DRAWN PG	REVISED	

December 7, 2020

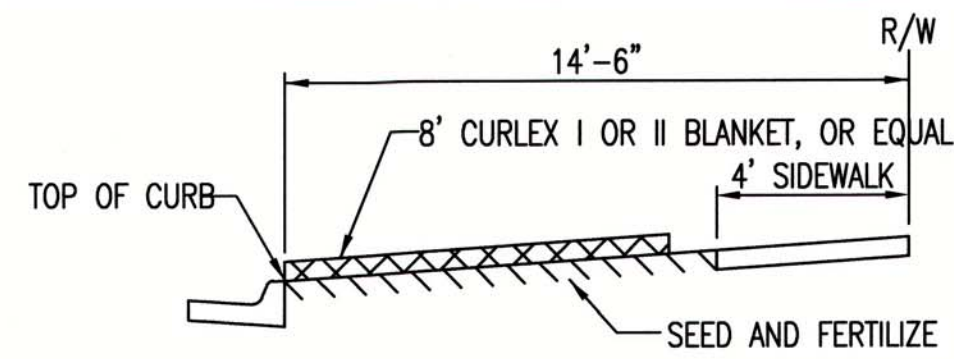

SECTION B-B

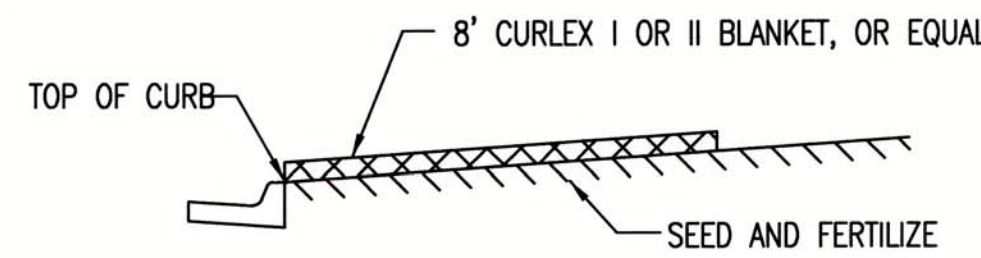

SECTION A-A

INSTALL 8' WIDE CURLEX I OR II EXCELSIOR BLANKET, OR EQUAL, ON PREPARED SURFACE BACK OF CURB. EDGE OF BLANKET WILL BE AT BACK OF CURB. INSTALL PER MANUFACTURERS RECOMMENDATION, INCLUDING STAPLES. (SEE DETAIL)

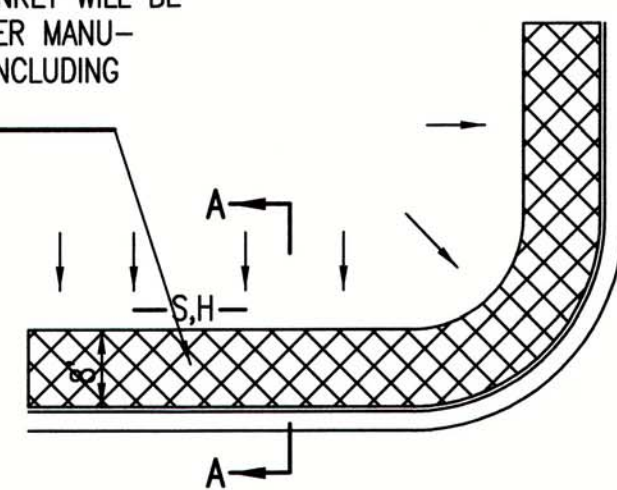

SOUTH STREET

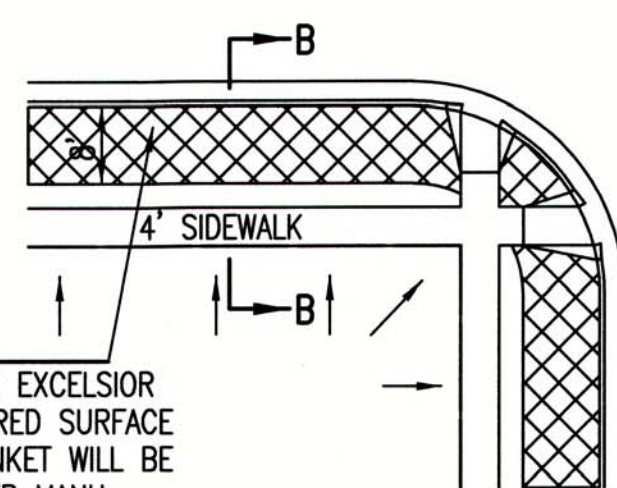

INSTALL 8' WIDE CURLEX I OR II EXCELSIOR BLANKET, OR EQUAL, ON PREPARED SURFACE BACK OF CURB. EDGE OF BLANKET WILL BE AT BACK OF CURB. INSTALL PER MANUFACTURERS RECOMMENDATION, INCLUDING STAPLES. (SEE DETAIL)

GENERAL NOTES

- EXCELSIOR MAT TO BE INSTALLED WHEN SOD IS NOT SPECIFIED ON PROJECT.
- EXCELSIOR BLANKET TO BE INSTALLED OVER SEED AND FERTILIZER, AS SPECIFIED IN THE PROJECT SPECIFICATIONS.
- AFTER INSTALLATION OF EXCELSIOR BLANKET, AT LOCATIONS WHERE CONCENTRATED FLOW CARRIES SEDIMENT OVER THE CURB AND INTO THE GUTTER, SUPPLEMENTAL EROSION CONTROL DEVICES WILL BE INSTALLED BY THE CONTRACTOR AS NEEDED, TO FIX THE PROBLEM.

BACK OF CURB PROTECTION DETAIL

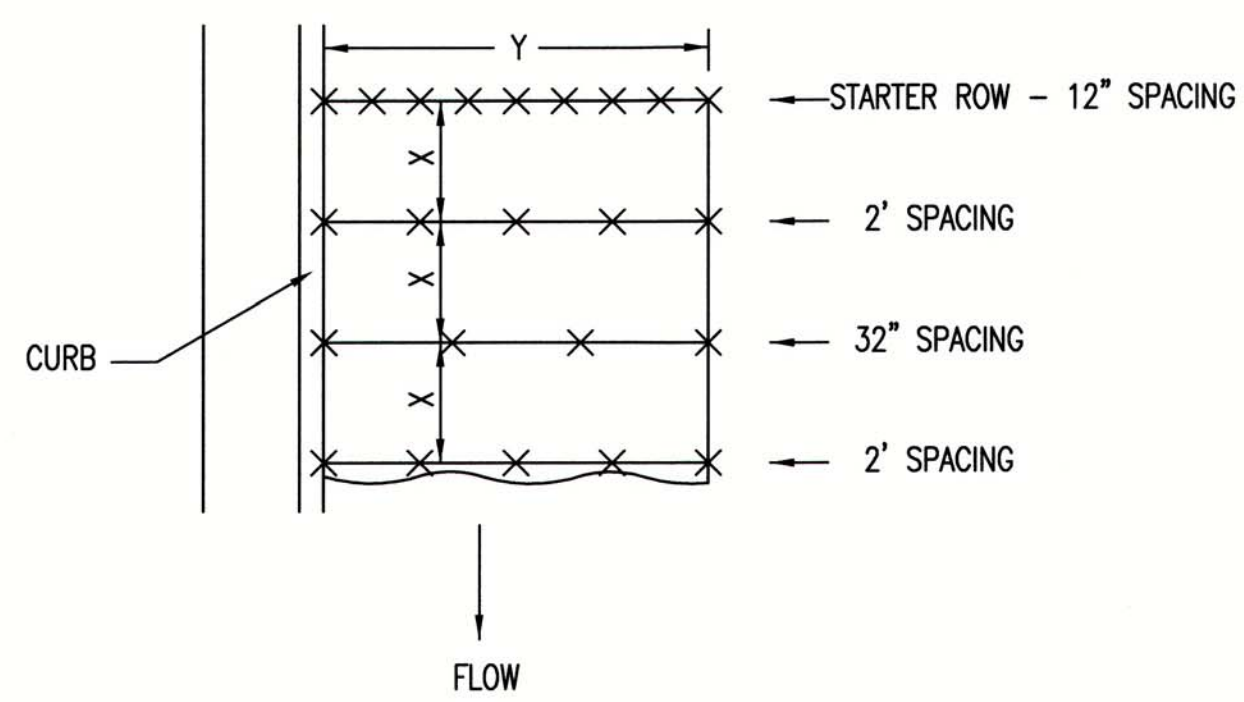

NOTES: USE 6" SEAM OVERLAP
(X & Y = RECOMMENDED BY MANUFACTURE)

DETAILS FOR APPROVED EROSION CONTROL MAT

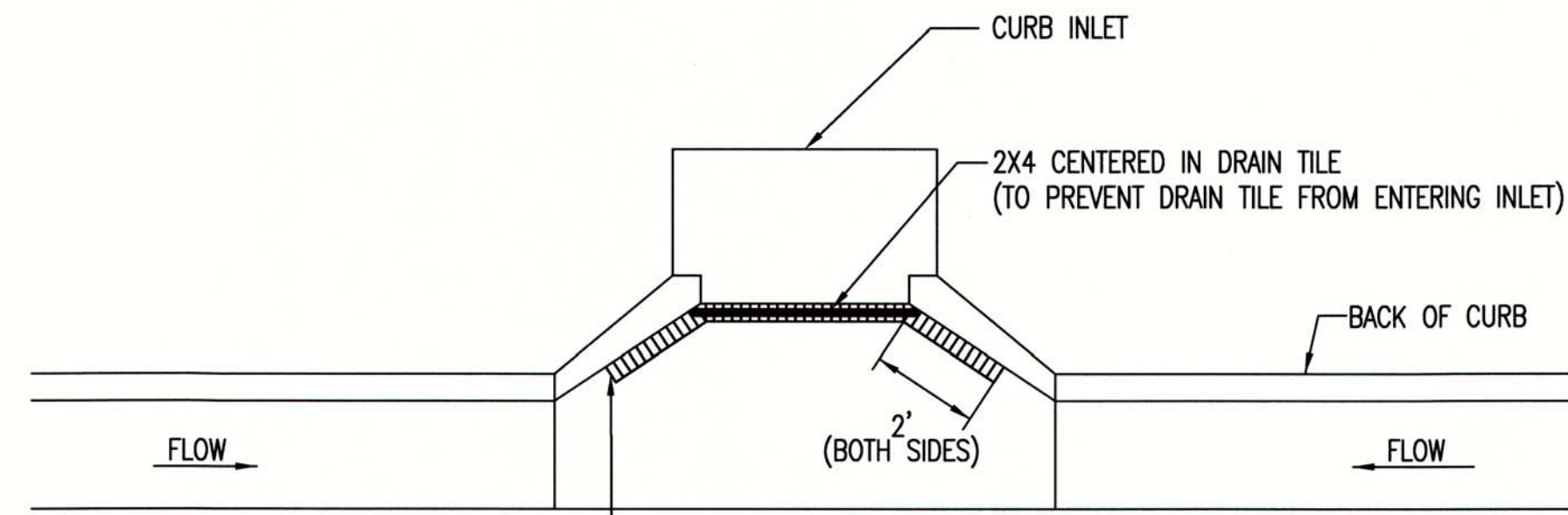

NOTE: PLACE 4" PERFORATED PVC PIPE, FILLED WITH 1/2"-1" DIA. GRAVEL, IN FRONT OF CURB INLET AS SHOWN.

2X4 LENGTH	INLET TYPE	INLET OPENING
5'-6"	1-A	5'-0"
10'-6"	1-A	10'-0"
15'-6"	1-A	15'-0"

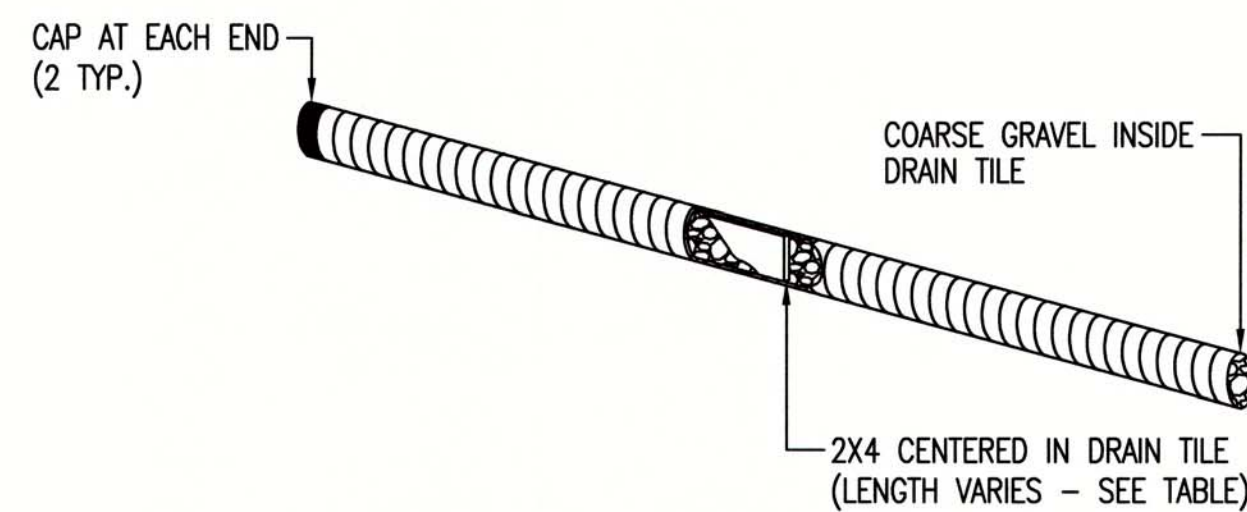

CURB INLET PROTECTION
4" PERFORATED PIPE W/ GRAVEL

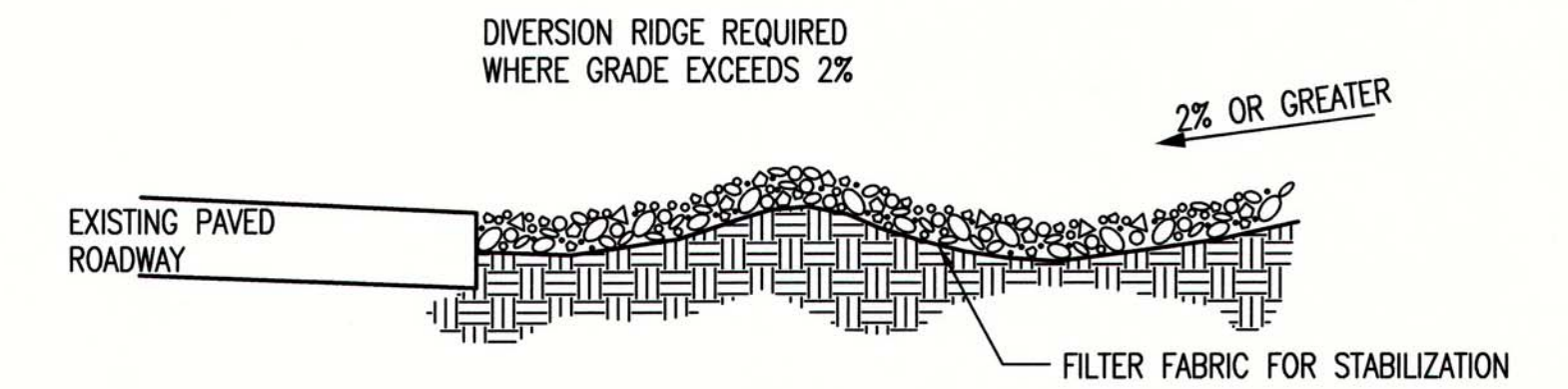

SECTION C-C

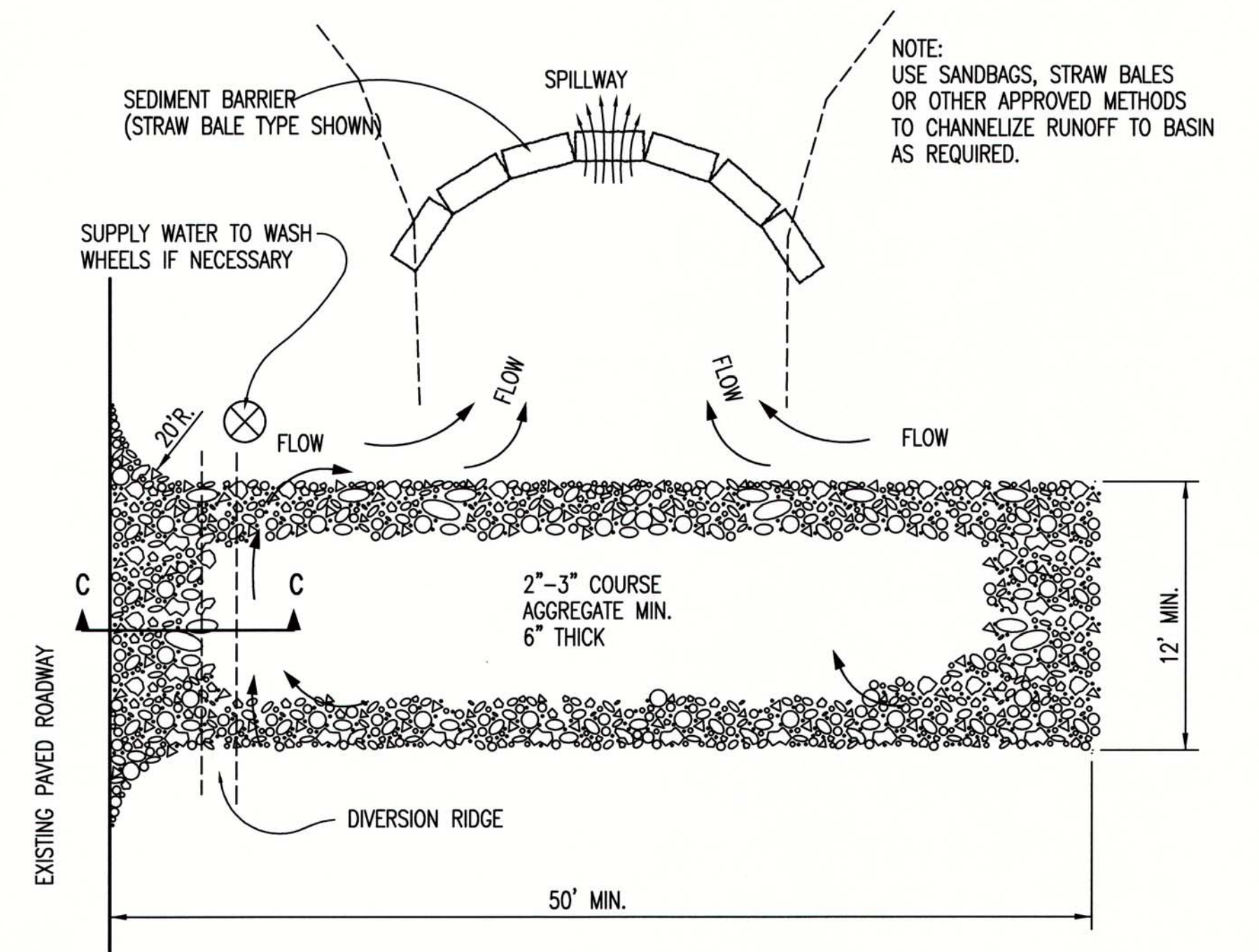

STABILIZED CONSTRUCTION ENTRANCE

GENERAL NOTES

- THE ENTRANCE SHALL BE MAINTAINED IN A CONDITION THAT WILL PREVENT TRACKING OR FLOWING OF SEDIMENT ONTO PUBLIC RIGHTS-OF-WAY. THIS MAY REQUIRE TOP DRESSING, REPAIR AND/OR CLEANOUT OF ANY MEASURES USED TO TRAP SEDIMENT.
- WHEN NECESSARY, WHEELS SHALL BE CLEANED PRIOR TO ENTRANCE ONTO PUBLIC RIGHT-OF-WAY.
- WHEN WASHING IS REQUIRED, IT SHALL BE DONE ON AN AREA STABILIZED WITH CRUSHED STONE THAT DRAINS INTO AN APPROVED SEDIMENT TRAP OR SEDIMENT BASIN, AS SHOWN ABOVE.
- DRIVE ENTRANCES ONTO RESIDENTIAL LOTS WILL NOT BE REQUIRED TO HAVE THE SEDIMENT BARRIER SHOWN, BUT WHEEL WASHING MAY BE REQUIRED IF STABILIZED ENTRANCE IS NOT SUFFICIENT TO KEEP MUD FROM BEING TRACKED ONTO ADJACENT STREET. ENTRANCE SHALL EXTEND FROM BACK OF CURB TO DWELLING.

REVISION DATE: MAY 2013



05/26/13

CITY OF WICHITA
PUBLIC WORKS & UTILITIES
ENGINEERING DIVISION

**BACK OF CURB PROTECTION,
CURB INLET PROTECTION AND
CONSTRUCTION ENTRANCE**

CITY ENGINEER
GARY JANZEN, P.E.

PROJECT NUMBER OCA NUMBER DATE

CITY ENGINEER'S OFFICE
CITY HALL - SEVENTH FLOOR
455 NORTH MAIN STREET
WICHITA, KANSAS 67202-1620
(316) 268-4501

SHEET
5.1

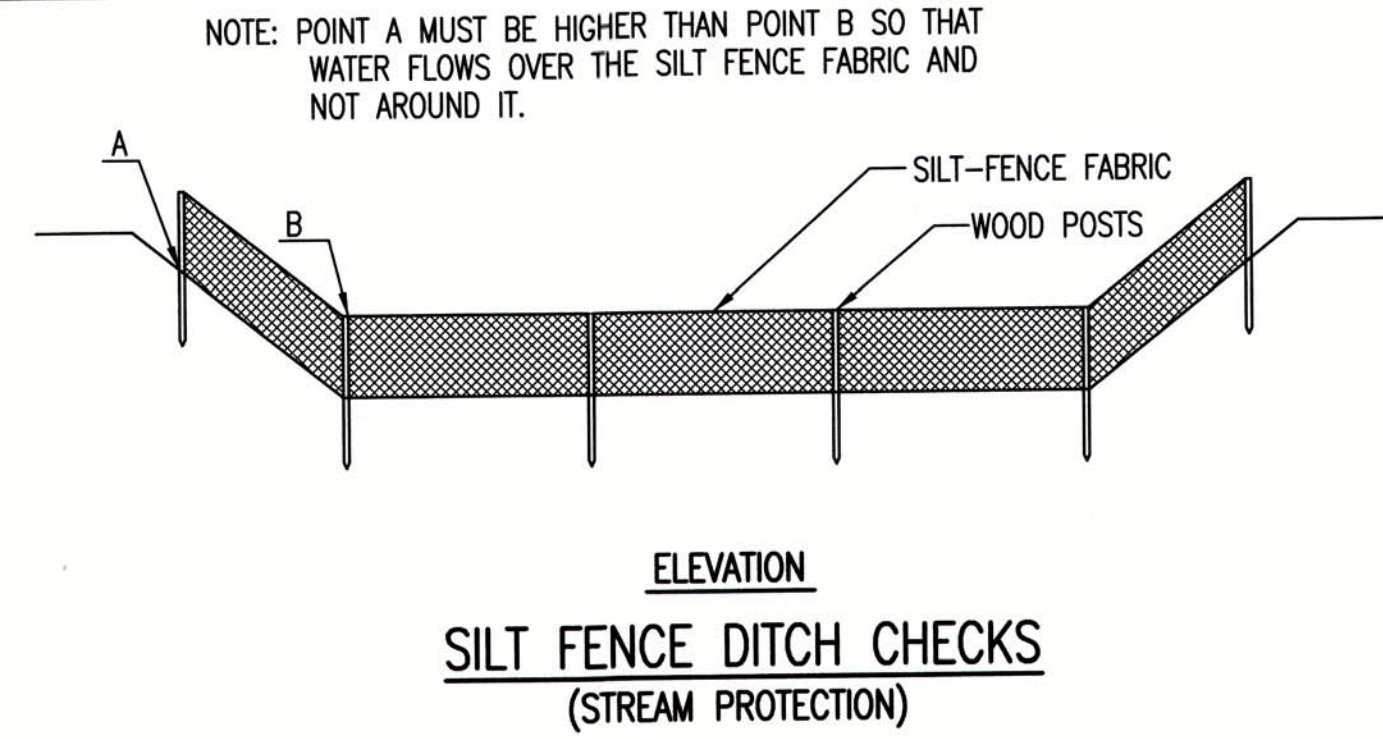

ELEVATION
SILT FENCE DITCH CHECKS
(STREAM PROTECTION)

MATERIAL SPECIFICATION:

SILT FENCE FABRIC SHOULD CONFORM TO THE AASHTO M288 96 SILT FENCE SPECIFICATION. THE POSTS USED TO SUPPORT THE SILT FENCE FABRIC SHOULD BE A HARDWOOD MATERIAL WITH THE FOLLOWING MINIMUM DIMENSIONS: 2" SQUARE (NOMINAL) BY 4' LONG. SILT FENCE FABRIC SHOULD BE ATTACHED TO THE WOODEN POSTS WITH STAPLES, WIRE, ZIP TIES, OR NAILS.

PLACEMENT:

PLACE SILT FENCE IN DITCHES WHERE IT IS UNLIKELY THAT IT WILL BE OVERTOPPED. WATER SHOULD FLOW THROUGH A SILT FENCE DITCH CHECK, NOT OVER IT. SILT FENCE DITCH CHECKS OFTEN FAIL WHEN OVERTOPPED. SILT FENCE DITCH CHECKS SHOULD BE PLACED PERPENDICULAR TO THE FLOWLINE OF THE DITCH. THE SILT FENCE SHOULD EXTEND FAR ENOUGH SO THAT THE GROUND LEVEL AT THE ENDS OF THE FENCE IS HIGHER THAN THE TOP OF THE LOW POINT OF THE FENCE. THIS PREVENTS WATER FROM FLOWING AROUND THE CHECK. SILT FENCE DITCH CHECKS SHOULD NOT BE PLACED IN DITCHES WHERE HIGH FLOWS ARE EXPECTED. ROCK CHECKS SHOULD BE USED INSTEAD. SILT FENCE SHOULD BE PLACED IN DITCHES WITH SLOPES OF 6% OR LESS. FOR SLOPES STEEPER THAN 6%, ROCK CHECKS SHOULD BE USED.

THE FOLLOWING TABLE PROVIDES CHECK SPACING FOR A GIVEN DITCH GRADE:

DITCH CHECK DITCH GRADE (%)	SPACING CHECK SPACING (FEET)
0.5	200
1.0	200
2.0	100
3.0	65
4.0	50
5.0	40
6.0	30

PROPER INSTALLATION METHOD:

EXCAVATE A TRENCH PERPENDICULAR TO THE DITCH FLOWLINE THAT IS AT LEAST 12" DEEP BY 6" WIDE. EXTEND THE TRENCH IN A STRAIGHT LINE ALONG THE ENTIRE LENGTH OF THE PROPOSED DITCH CHECK. PLACE THE SOIL ON THE UPSLOPE SIDE OF THE TRENCH FOR LATER USE. ROLL OUT A CONTINUOUS LENGTH OF SILT FENCE FABRIC ON THE DOWNSLOPE SIDE OF THE TRENCH. PLACE THE EDGE OF THE FABRIC IN THE TRENCH STARTING AT THE TOP UPSLOPE EDGE OF THE TRENCH. LINE TWO SIDES OF THE TRENCH WITH THE FABRIC AS SHOWN ON DETAIL. BACKFILL OVER THE FABRIC IN THE TRENCH WITH THE EXCAVATED SOIL AND COMPACT. AFTER FILLING THE TRENCH, APPROXIMATELY 24" TO 36" OF SILT FENCE FABRIC SHOULD REMAIN EXPOSED. LAY THE EXPOSED SILT FENCE ON THE UPSLOPE SIDE OF THE TRENCH TO CLEAR AN AREA FOR DRIVING IN THE POSTS. JUST DOWNSLOPE OF THE TRENCH, DRIVE POSTS INTO THE GROUND TO A DEPTH OF AT LEAST 24". PLACE POSTS NO MORE THAN 4' APART. ATTACH THE SILT FENCE TO THE ANCHORED POST WITH STAPLES, WIRE, ZIP TIES, OR NAILS.

LIST OF COMMON PLACEMENT/INSTALLATION MISTAKES TO AVOID:

WATER SHOULD FLOW THROUGH A SILT FENCE DITCH CHECK—NOT OVER IT. PLACE SILT FENCE IN DITCHES WHERE IT IS UNLIKELY THAT IT WILL BE OVERTOPPED. SILT FENCE INSTALLATIONS QUICKLY DETERIORATE WHEN WATER OVERTOPS THEM. DO NOT PLACE SILT FENCE POSTS ON THE UPSLOPE SIDE OF THE SILT FENCE FABRIC. IN THIS CONFIGURATION, THE FORCE OF THE WATER IS NOT RESTRICTED BY THE POSTS, BUT ONLY BY THE STAPLES (WIRE, ZIP TIES, NAILS, ETC.). THE SILT FENCE WILL RIP AND FAIL. DO NOT PLACE A SILT FENCE DITCH CHECK DIRECTLY IN FRONT OF A CULVERT OUTLET. IT WILL NOT STAND UP TO THE CONCENTRATED FLOW. DO NOT PLACE SILT FENCE DITCH CHECKS IN DITCHES THAT WILL LIKELY EXPERIENCE HIGH FLOWS. THEY WILL NOT STAND UP TO CONCENTRATED FLOW. FOLLOW PRESCRIBED DITCH CHECK SPACING GUIDELINES. IF SPACING GUIDELINES ARE EXCEEDED, EROSION WILL OCCUR BETWEEN THE DITCH CHECKS. DO NOT ALLOW WATER TO FLOW AROUND THE DITCH CHECK. MAKE SURE THAT THE DITCH CHECK IS LONG ENOUGH SO THAT THE GROUND LEVEL AT THE ENDS OF THE FENCE IS HIGHER THAN THE LOW POINT ON THE TOP OF THE FENCE. DO NOT PLACE SILT FENCE DITCH CHECKS IN CHANNELS WITH SHALLOW SOILS UNDERLAIN BY ROCK. IF THE CHECK IS NOT ANCHORED SUFFICIENTLY, IT WILL WASH OUT.

INSPECTION AND MAINTENANCE:

SILT FENCE DITCH CHECKS SHOULD BE INSPECTED EVERY 7 DAYS AND WITHIN 24 HOURS OF A RAINFALL OF 1/2" OR MORE. THE FOLLOWING IS A LIST OF QUESTIONS THAT SHOULD BE ADDRESSED DURING EACH INSPECTION:

- DOES WATER FLOW AROUND THE DITCH CHECK?
- DOES WATER FLOW UNDER THE DITCH CHECK?
- DOES THE SILT FENCE SAG EXCESSIVELY?
- HAS THE SILT FENCE TORN OR BECOME DETACHED FROM THE POSTS?
- DOES SEDIMENT NEED TO BE REMOVED FROM BEHIND THE DITCH CHECK?

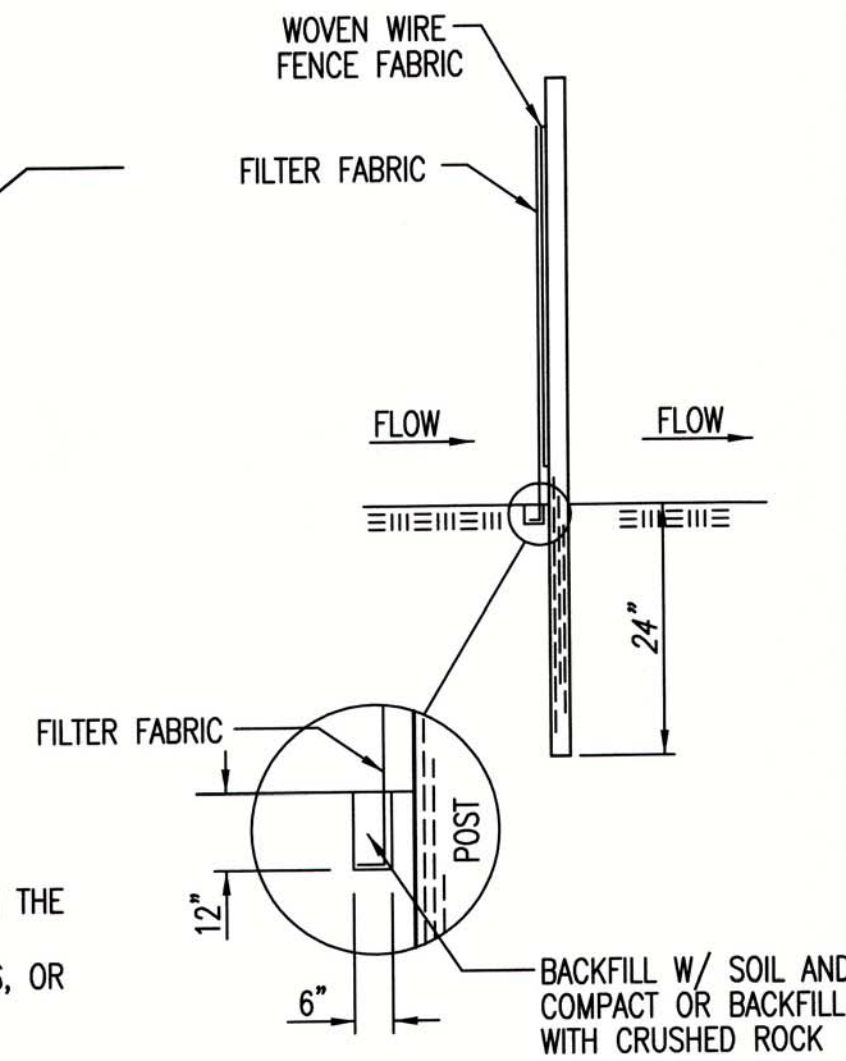

ANCHOR TRENCH DETAIL

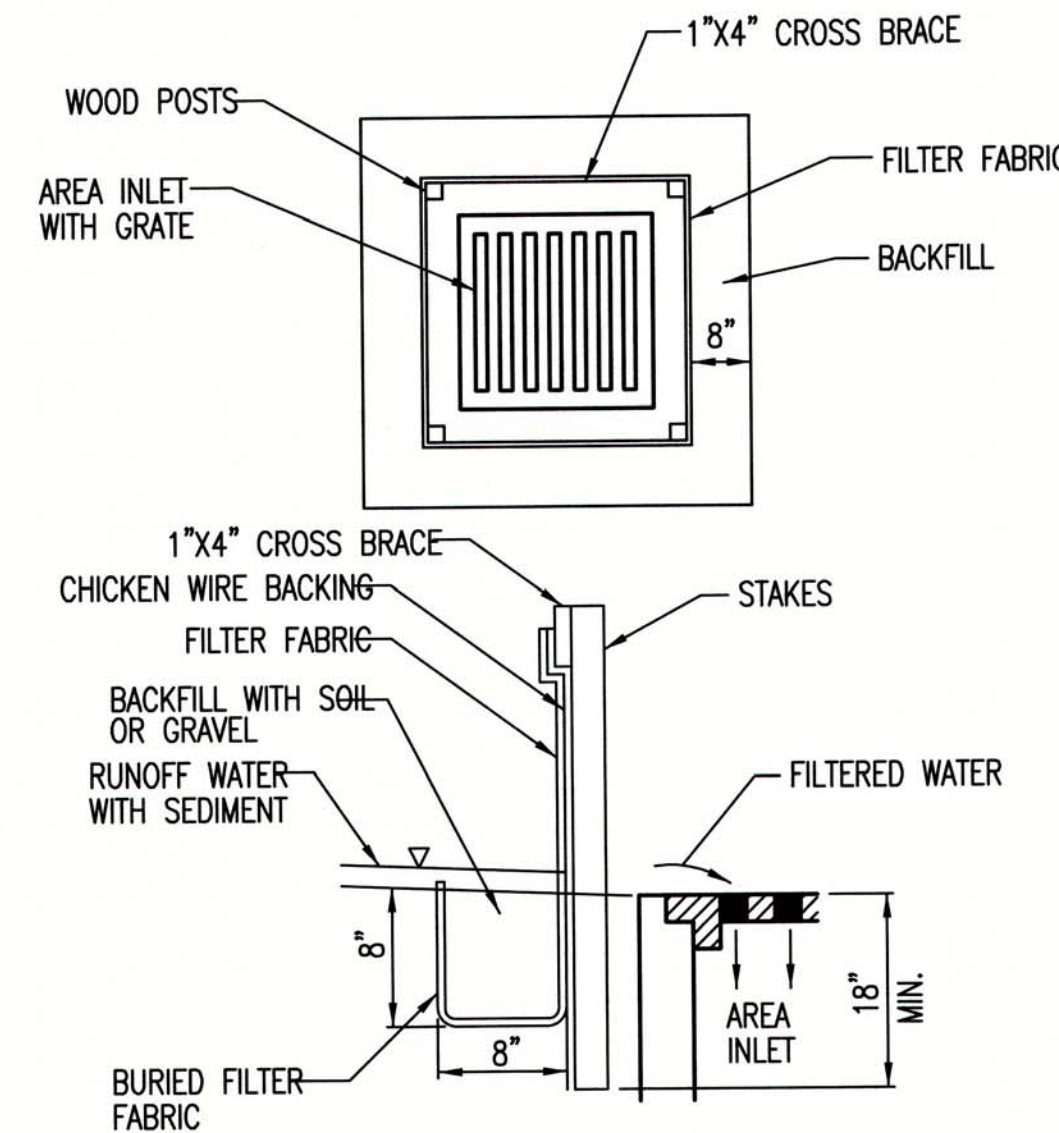

SILT FENCE BARRIERS FOR AREA INLETS
(INLET PROTECTION)

MATERIAL SPECIFICATION:

SILT FENCE FABRIC SHOULD CONFORM TO THE AASHTO M288 96 SILT FENCE SPECIFICATION. THE WIRE OR POLYMERIC MESH BACKING USED TO HELP SUPPORT THE SILT FENCE FABRIC SHOULD CONFORM TO THE AASHTO M288 96 SILT FENCE SPECIFICATION. THE POSTS USED TO SUPPORT THE SILT FENCE FABRIC SHOULD BE A HARDWOOD MATERIAL WITH THE FOLLOWING MINIMUM DIMENSIONS: 2" SQUARE (NOMINAL) BY 4' LONG. THE MATERIAL USED TO FRAME THE TOPS OF THE POSTS SHOULD BE 1" BY 4" BOARDS. SILT FENCE FABRIC AND SUPPORT BACKING SHOULD BE ATTACHED TO THE WOODEN POSTS AND FRAME WITH STAPLES, WIRE, ZIP TIES, OR NAILS.

PLACEMENT:

PLACE A SILT FENCE DROP INLET BARRIER IN A LOCATION WHERE IT IS UNLIKELY TO BE OVERTOPPED. WATER SHOULD FLOW THROUGH SILT FENCE, NOT OVER IT. SILT FENCE BARRIERS FOR AREA INLETS OFTEN FAIL WHEN REPEATEDLY OVERTOPPED. WHEN USED AS A BARRIER FOR AREA INLETS, SILT FENCE FABRIC AND POSTS MUST BE SUPPORTED AT THE TOP BY A WOODEN FRAME. WHEN A SILT FENCE BARRIER FOR AREA INLETS IS LOCATED NEAR AN INLET THAT HAS STEEP APPROACH SLOPES, THE STORAGE CAPACITY BEHIND THE BARRIER IS DRASTICALLY REDUCED. TIMELY REMOVAL OF SEDIMENT MUST OCCUR FOR A BARRIER TO OPERATE PROPERLY IN THIS LOCATION.

PROPER INSTALLATION METHOD:

EXCAVATE A TRENCH AROUND THE PERIMETER OF THE AREA INLET THAT IS AT LEAST 8" DEEP BY 8" WIDE. DRIVE POSTS TO A DEPTH OF AT LEAST 18" AROUND THE PERIMETER OF THE AREA INLET. THE DISTANCE BETWEEN POSTS SHOULD BE 4' OR LESS. IF THE DISTANCE BETWEEN TWO ADJACENT CORNER POSTS IS MORE THAN 4', ADD ANOTHER POST(S) BETWEEN THEM. CONNECT THE TOPS OF ALL THE POSTS WITH A WOODEN FRAME MADE OF 1" BY 4" BOARDS. USE NAILS OR SCREWS FOR FASTENING. ATTACH THE WIRE OR POLYMERIC-MESH BACKING TO THE OUTSIDE OF THE POST/FRAME STRUCTURE WITH STAPLES, WIRE, ZIP TIES, OR NAILS. ROLL OUT A CONTINUOUS LENGTH OF SILT FENCE FABRIC LONG ENOUGH TO WRAP AROUND THE PERIMETER OF THE AREA INLET. ADD MORE LENGTH FOR OVERLAPPING THE FABRIC JOINT. PLACE THE EDGE OF THE FABRIC IN THE TRENCH, STARTING AT THE OUTSIDE EDGE OF THE TRENCH. LINE ALL THREE SIDES OF THE TRENCH WITH THE FABRIC. BACKFILL OVER THE FABRIC IN THE TRENCH WITH THE EXCAVATED SOIL AND COMPACT. AFTER FILLING THE TRENCH, APPROXIMATELY 24" TO 36" OF SILT FENCE FABRIC SHOULD REMAIN EXPOSED. ATTACH THE SILT FENCE TO THE OUTSIDE OF THE POST/FRAME STRUCTURE WITH STAPLES, WIRE, ZIP TIES, OR NAILS. THE JOINT SHOULD BE OVERLAPPED TO THE NEXT POST.

NOTE: WHEN A SILT FENCE BARRIER FOR AREA INLET IS PLACED IN A SHALLOW MEDIAN DITCH, MAKE SURE THAT THE TOP OF THE BARRIER IS NOT HIGHER THAN THE PAVED ROAD. IN THIS CONFIGURATION, WATER MAY SPREAD ONTO THE ROADWAY CAUSING A HAZARDOUS CONDITION.

LIST OF COMMON PLACEMENT/INSTALLATION MISTAKES TO AVOID:

WATER SHOULD FLOW THROUGH A SILT FENCE BARRIER FOR AREA INLET—NOT OVER IT. PLACE A SILT FENCE BARRIER FOR AREA INLET IN A LOCATION WHERE IT IS UNLIKELY TO BE OVERTOPPED. SILT FENCE BARRIER FOR AREA INLETS OFTEN FAIL WHEN REPEATEDLY OVERTOPPED. DO NOT PLACE POSTS ON THE OUTSIDE OF THE SILT FENCE BARRIER FOR AREA INLET. IN THIS CONFIGURATION, THE FORCE OF THE WATER IS NOT RESTRICTED BY THE POSTS, BUT ONLY BY THE STAPLES (WIRE, ZIP TIES, NAILS, ETC.). THE SILT FENCE WILL RIP AND FAIL. DO NOT INSTALL SILT FENCE BARRIER FOR AREA INLETS WITHOUT FRAMING THE TOP OF THE POSTS. THE CORNER POSTS AROUND AREA INLETS ARE STRESSED IN TWO DIRECTIONS WHEREAS A NORMAL SILT FENCE IS ONLY STRESSED IN ONE DIRECTION. THIS ADDED STRESS REQUIRES MORE SUPPORT.

INSPECTION AND MAINTENANCE:

SILT FENCE BARRIER FOR AREA INLETS SHOULD BE INSPECTED EVERY 7 DAYS AND WITHIN 24 HOURS OF A RAINFALL OF 1/2" OR MORE. THE FOLLOWING IS A LIST OF QUESTIONS THAT SHOULD BE ADDRESSED DURING EACH INSPECTION:

- DOES WATER FLOW UNDER THE SILT FENCE?
- DOES THE SILT FENCE SAG EXCESSIVELY?
- HAS THE SILT FENCE TORN OR BECOME DETACHED FROM THE POSTS?
- DOES SEDIMENT NEED TO BE REMOVED FROM BEHIND THE AREA INLET BARRIER?

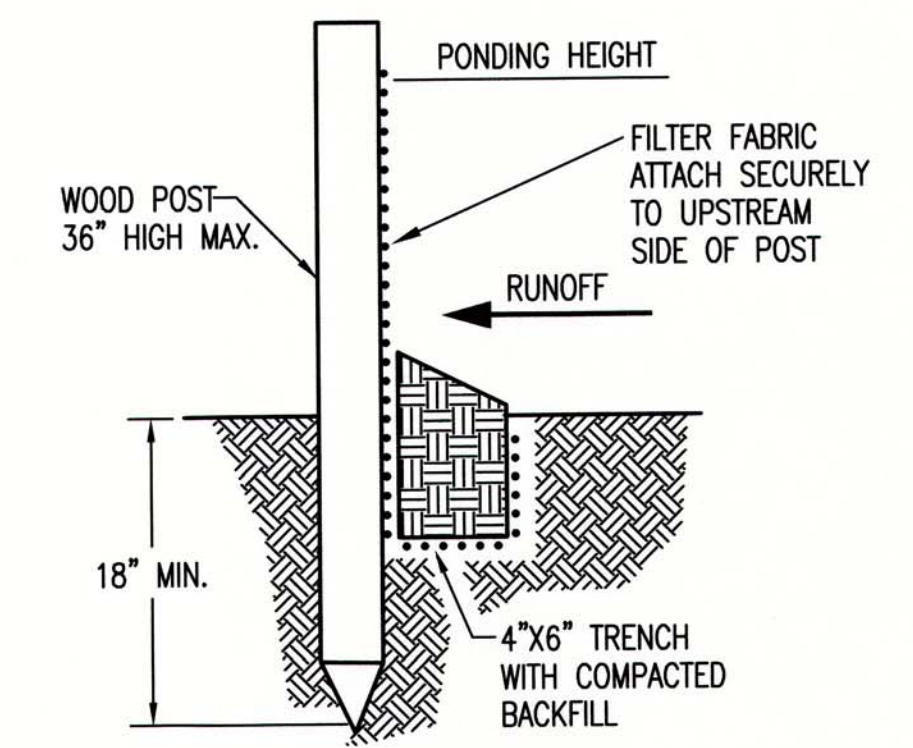

SILT FENCE BARRIERS

MATERIAL SPECIFICATION:

SILT FENCE FABRIC SHOULD CONFORM TO THE AASHTO M288 96 SILT FENCE SPECIFICATION. THE POSTS USED TO SUPPORT THE SILT FENCE FABRIC SHOULD BE A HARDWOOD MATERIAL WITH THE FOLLOWING MINIMUM DIMENSIONS: 2" SQUARE (NOMINAL) BY 4' LONG. SILT FENCE FABRIC SHOULD BE ATTACHED TO THE WOODEN POSTS WITH STAPLES, WIRE, ZIP TIES, OR NAILS.

PLACEMENT:

A SLOPE BARRIER SHOULD BE USED AT THE TOE OF A SLOPE WHEN A DITCH DOES NOT EXIST. THE SLOPE BARRIER SHOULD BE PLACED ON NEARLY LEVEL GROUND 5' TO 10' AWAY FROM THE TOE OF A SLOPE. THE BARRIER IS PLACED AWAY FROM THE TOE OF THE SLOPE TO PROVIDE ADEQUATE STORAGE FOR SETTLING OUT SEDIMENT. WHEN PRACTICABLE, SILT FENCE SLOPE BARRIERS SHOULD BE PLACED ALONG CONTOURS TO AVOID A CONCENTRATION OF FLOW. SILT FENCE SLOPE BARRIERS CAN ALSO BE PLACED ALONG RIGHT-OF-WAY FENCE LINES TO KEEP SEDIMENT FROM CROSSING ONTO ADJACENT PROPERTY. WHEN PLACED IN THIS MANNER, THE SLOPE BARRIER WILL NOT LIKELY FOLLOW CONTOURS.

PROPER INSTALLATION METHOD:

EXCAVATE A TRENCH THE LENGTH OF THE PLANNED SLOPE BARRIER THAT IS 6" DEEP BY 4" WIDE. MAKE SURE THAT THE TRENCH IS EXCAVATED ALONG A SINGLE CONTOUR. WHEN PRACTICABLE, SLOPE BARRIERS SHOULD BE PLACED ALONG CONTOURS TO AVOID A CONCENTRATION OF FLOW. PLACE THE SOIL ON THE UPSLOPE SIDE OF THE TRENCH FOR LATER USE. ROLL OUT A CONTINUOUS LENGTH OF SILT FENCE FABRIC ON THE DOWNSLOPE SIDE OF THE TRENCH. PLACE THE EDGE OF THE FABRIC IN THE TRENCH STARTING AT THE TOP UPSLOPE EDGE. LINE ALL THREE SIDES OF THE TRENCH WITH THE FABRIC. BACKFILL OVER THE FABRIC IN THE TRENCH WITH THE EXCAVATED SOIL AND COMPACT. AFTER FILLING THE TRENCH, APPROXIMATELY 24" TO 36" OF SILT-FENCE FABRIC SHOULD REMAIN EXPOSED. LAY THE EXPOSED SILT FENCE UPSLOPE OF THE TRENCH TO CLEAR AN AREA FOR DRIVING IN THE POSTS. JUST DOWNSLOPE OF THE TRENCH, DRIVE POSTS INTO THE GROUND TO A DEPTH OF AT LEAST 18". PLACE POSTS NO MORE THAN 4' APART. ATTACH THE SILT FENCE TO THE ANCHORED POST WITH STAPLES, WIRE, ZIP TIES, OR NAILS.

LIST OF COMMON PLACEMENT/INSTALLATION MISTAKES TO AVOID:

WHEN PRACTICABLE, DO NOT PLACE SILT FENCE SLOPE BARRIERS ACROSS CONTOURS. SLOPE BARRIERS SHOULD BE PLACED ALONG CONTOURS TO AVOID A CONCENTRATION OF FLOW. WHEN THE FLOW CONCENTRATES, IT OVERTOPS THE BARRIER AND THE SILT FENCE SLOPE BARRIER QUICKLY DETERIORATES. DO NOT PLACE SILT-FENCE POSTS ON THE UPSLOPE SIDE OF THE SILT FENCE FABRIC. IN THIS CONFIGURATION, THE FORCE OF THE WATER IS NOT RESTRICTED BY THE POSTS, BUT ONLY BY THE STAPLES (WIRE, ZIP TIES, NAILS, ETC.). THE SILT FENCE WILL RIP AND FAIL. DO NOT PLACE SILT FENCE SLOPE BARRIERS IN AREAS WITH SHALLOW SOILS UNDERLAIN BY ROCK. IF THE BARRIER IS NOT SUFFICIENTLY ANCHORED, IT WILL WASH OUT. SILT FENCE SLOPE BARRIERS MUST BE DUG INTO THE GROUND—SILT FENCE AT GROUND LEVEL DOES NOT WORK BECAUSE WATER WILL FLOW UNDERNEATH.

INSPECTION AND MAINTENANCE:

SILT FENCE SLOPE BARRIERS SHOULD BE INSPECTED EVERY 7 DAYS AND WITHIN 24 HOURS OF A RAINFALL OF 1/2" OR MORE. THE FOLLOWING IS A LIST OF QUESTIONS THAT SHOULD BE ADDRESSED DURING EACH INSPECTION:

- ARE THERE ANY POINTS ALONG THE SLOPE BARRIER WHERE WATER IS CONCENTRATING?
- DOES WATER FLOW UNDER THE SLOPE BARRIER?
- DO THE SILT FENCES SAG EXCESSIVELY?
- HAS THE SILT FENCE TORN OR BECOME DETACHED FROM THE POSTS?
- DOES SEDIMENT NEED TO BE REMOVED FROM BEHIND THE SLOPE BARRIER?

REVISION DATE: MAY 2013



 CITY OF WICHITA PUBLIC WORKS & UTILITIES ENGINEERING DIVISION		
SILT FENCE DITCH CHECK AND BARRIER DETAILS		
CITY ENGINEER GARY JANZEN, P.E.		
PROJECT NUMBER	OCA NUMBER	DATE
CITY ENGINEER'S OFFICE CITY HALL - SEVENTH FLOOR 455 NORTH MAIN STREET WICHITA, KANSAS 67202-1620 (316) 268-4501		SHEET 5.2

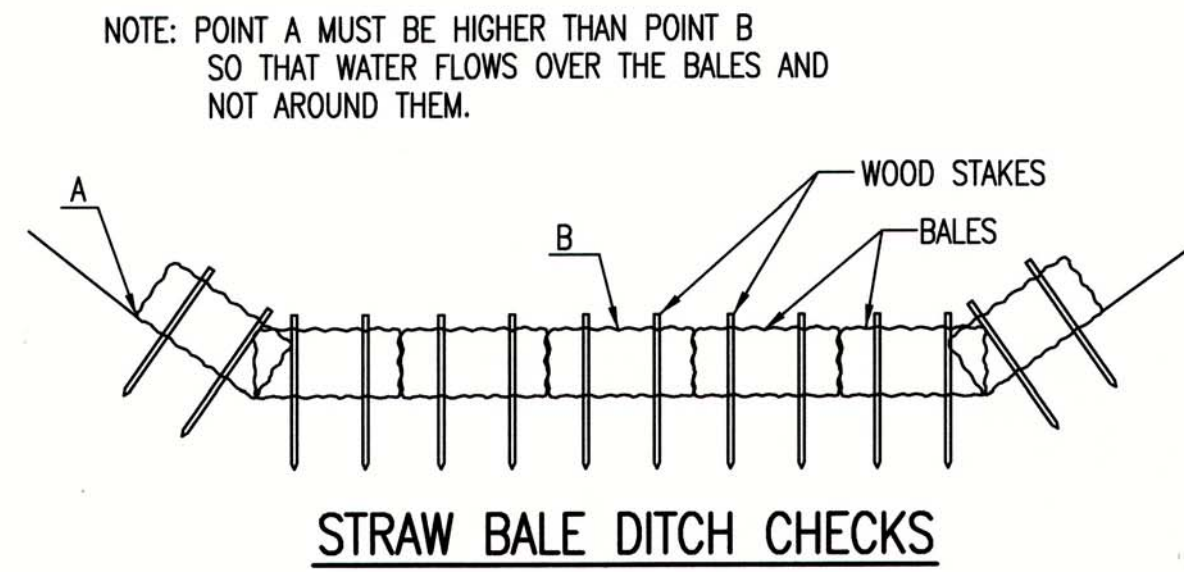

MATERIAL SPECIFICATION:

BALE DITCH CHECKS MAY BE CONSTRUCTED OF WHEAT STRAW, OAT STRAW, PRAIRIE HAY, OR BROMEGRASS HAY THAT IS FREE OF WEEDS DECLARED NOXIOUS BY THE KANSAS STATE BOARD OF AGRICULTURE. THE STAKES USED TO ANCHOR THE BALES SHOULD BE A HARDWOOD MATERIAL WITH THE FOLLOWING MINIMUM DIMENSIONS: 2" SQUARE (NOMINAL) BY 4' LONG. OPTIONAL: THE DOWNSTREAM SCOUR APRON SHOULD BE CONSTRUCTED OF A DOUBLE-NETTED STRAW EROSION-CONTROL BLANKET AT LEAST 6' WIDE. OPTIONAL: THE METAL LANDSCAPE STAPLES USED TO ANCHOR THE EROSION-CONTROL BLANKET SHOULD BE AT LEAST 8" LONG.

PLACEMENT:

BALE DITCH CHECKS SHOULD BE PLACED PERPENDICULAR TO THE FLOWLINE OF THE DITCH. THE DITCH CHECK SHOULD EXTEND FAR ENOUGH SO THAT THE GROUND LEVEL AT THE ENDS OF THE CHECK IS HIGHER THAN THE TOP OF THE LOWEST CENTER BALE. THIS PREVENTS WATER FROM FLOWING AROUND THE CHECK. STRAW BALE DITCH CHECKS SHOULD NOT BE PLACED IN DITCHES WHERE HIGH FLOWS ARE EXPECTED. ROCK CHECKS SHOULD BE USED INSTEAD. BALES SHOULD BE PLACED IN DITCHES WITH SLOPES OF 6% OR LESS. FOR SLOPES STEEPER THAN 6%, ROCK CHECKS SHOULD BE USED. THE FOLLOWING TABLE PROVIDES CHECK SPACING FOR A GIVEN DITCH GRADE:

DITCH CHECK SPACING DITCH GRADE (%)	CHECK SPACING (FEET)
0.5	200
1.0	200
2.0	100
3.0	65
4.0	50
5.0	40
6.0	30

PROPER INSTALLATION METHOD:

EXCAVATE A TRENCH PERPENDICULAR TO THE DITCH FLOWLINE THAT IS 4" DEEP AND A BALE'S WIDTH WIDE. EXTEND THE TRENCH IN A STRAIGHT LINE ALONG THE ENTIRE LENGTH OF THE PROPOSED DITCH CHECK. PLACE THE SOIL ON THE UPSTREAM SIDE OF THE TRENCH-IT WILL BE USED LATER. OPTIONAL: ON THE DOWNSTREAM SIDE OF THE TRENCH, ROLL OUT A LENGTH OF EROSION-CONTROL BLANKET (SCOUR APRON) EQUAL TO THE LENGTH OF THE TRENCH. PLACE THE UPSTREAM EDGE OF THE EROSION-CONTROL BLANKET ALONG THE BOTTOM UPSTREAM EDGE OF THE TRENCH. THE EROSION CONTROL BLANKET SHOULD BE ANCHORED IN THE TRENCH WITH ONE ROW OF 8" LANDSCAPE STAPLES PLACED ON 18" CENTERS. THE REMAINDER OF THE EROSION-CONTROL BLANKET (THE PORTION THAT IS NOT LYING IN THE TRENCH) WILL SERVE AS THE DOWNSTREAM SCOUR APRON. THIS SECTION OF THE BLANKET SHOULD BE ANCHORED TO THE GROUND WITH 8" LANDSCAPE STAPLES PLACED AROUND THE PERIMETER OF THE BLANKET ON 18" CENTERS. THE REMAINDER OF THE BLANKET SHOULD BE ANCHORED USING TWO EVENLY SPACED ROWS OF 8" LANDSCAPE STAPLES ON 18" CENTERS PLACED PERPENDICULAR TO THE FLOWLINE OF THE DITCH. PLACE THE BALES IN THE TRENCH, MAKING SURE THAT THEY ARE BUTTED TIGHTLY. TWO STAKES SHOULD BE DRIVEN THROUGH EACH BALE ALONG THE CENTERLINE OF THE DITCH CHECK, APPROXIMATELY 6" TO 8" IN FROM THE BALE ENDS. STAKES SHOULD BE DRIVEN AT LEAST 12" INTO THE GROUND. ONCE ALL THE BALES HAVE BEEN INSTALLED AND ANCHORED, PLACE THE EXCAVATED SOIL AGAINST THE UPSTREAM SIDE OF THE CHECK AND COMPACT IT. THE COMPACTED SOIL SHOULD BE NO MORE THAN 3" TO 4" DEEP AND EXTEND UPSTREAM NO MORE THAN 24".

LIST OF COMMON PLACEMENT/INSTALLATION MISTAKES TO AVOID:

DO NOT PLACE A BALE DITCH CHECK DIRECTLY IN FRONT OF A CULVERT OUTLET. IT WILL NOT STAND UP TO THE CONCENTRATED FLOW. DO NOT PLACE BALE DITCH CHECKS IN DITCHES THAT WILL LIKELY EXPERIENCE HIGH FLOWS. THEY WILL NOT STAND UP TO CONCENTRATED FLOW. FOLLOW PRESCRIBED DITCH-CHECK SPACING GUIDELINES. IF SPACING GUIDELINES ARE EXCEEDED, EROSION WILL OCCUR BETWEEN THE DITCH CHECKS. DO NOT ALLOW WATER TO FLOW AROUND THE DITCH CHECK. MAKE SURE THAT THE DITCH CHECK IS LONG ENOUGH SO THAT THE GROUND LEVEL AT THE ENDS OF THE CHECK IS HIGHER THAN THE TOP OF THE LOWEST CENTER BALE. DO NOT PLACE BALE DITCH CHECKS IN CHANNELS WITH SHALLOW SOILS UNDERLAIN BY ROCK. IF THE CHECK IS NOT ANCHORED SUFFICIENTLY, IT WILL WASH OUT. BALE DITCH CHECKS MUST BE DUG INTO THE GROUND. BALES AT GROUND LEVEL DO NOT WORK BECAUSE THEY ALLOW WATER TO FLOW UNDER THE CHECK.

INSPECTION AND MAINTENANCE:

BALE DITCH CHECKS SHOULD BE INSPECTED EVERY 7 DAYS AND WITHIN 24 HOURS OF A RAINFALL OF 1/2" OR MORE. THE FOLLOWING IS A LIST OF QUESTIONS THAT SHOULD BE ADDRESSED DURING EACH INSPECTION:

- DOES WATER FLOW AROUND THE DITCH CHECK?
- DOES WATER FLOW UNDER THE DITCH CHECK?
- DOES WATER FLOW THROUGH SPACES BETWEEN ABUTTING BALES?
- ARE ANY BALES AND/OR SCOUR APRONS (OPTIONAL) DISLODGED?
- ARE BALES DECOMPOSING DUE TO AGE AND/OR WATER DAMAGE?
- DOES SEDIMENT NEED TO BE REMOVED FROM BEHIND THE DITCH CHECK?

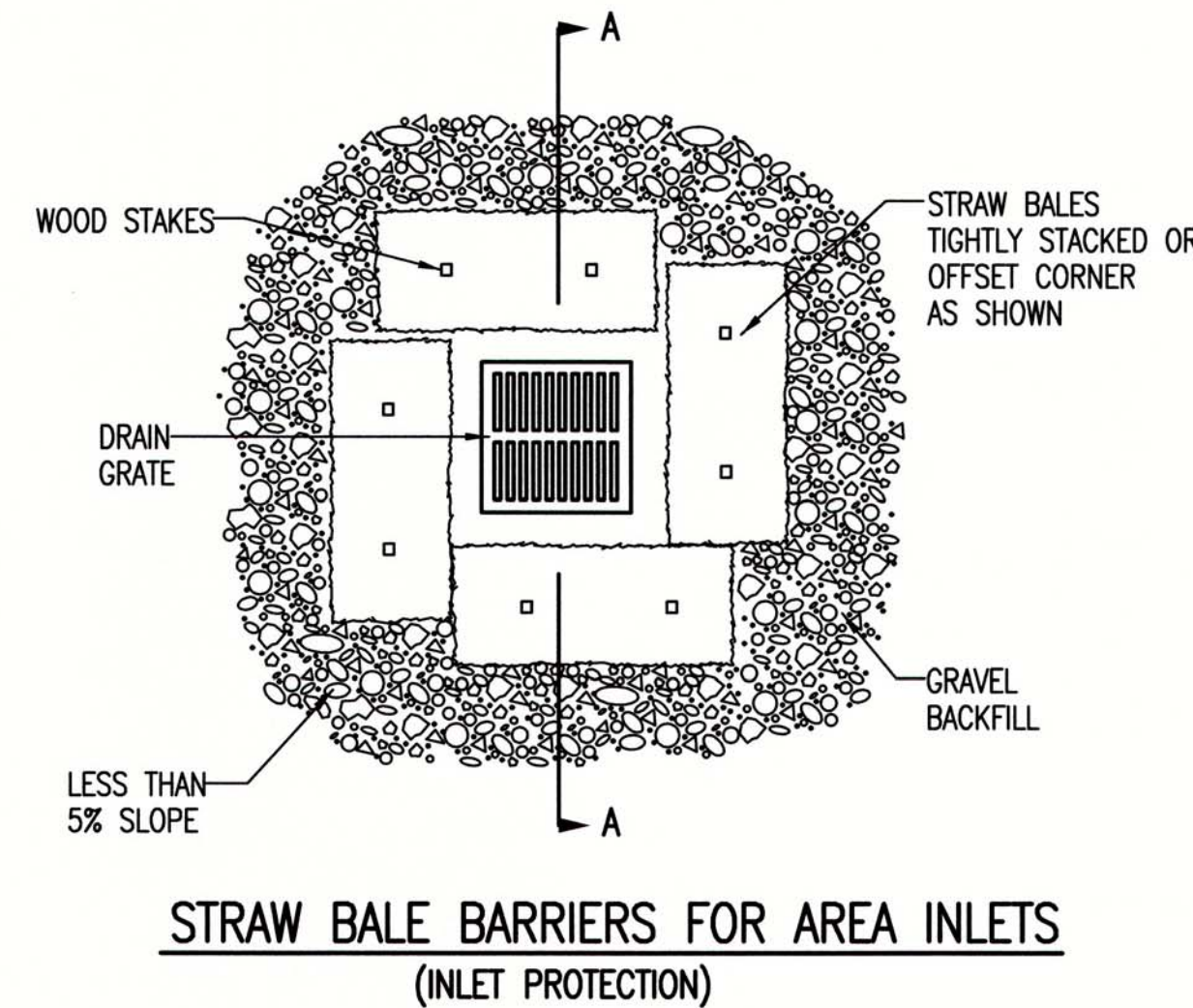
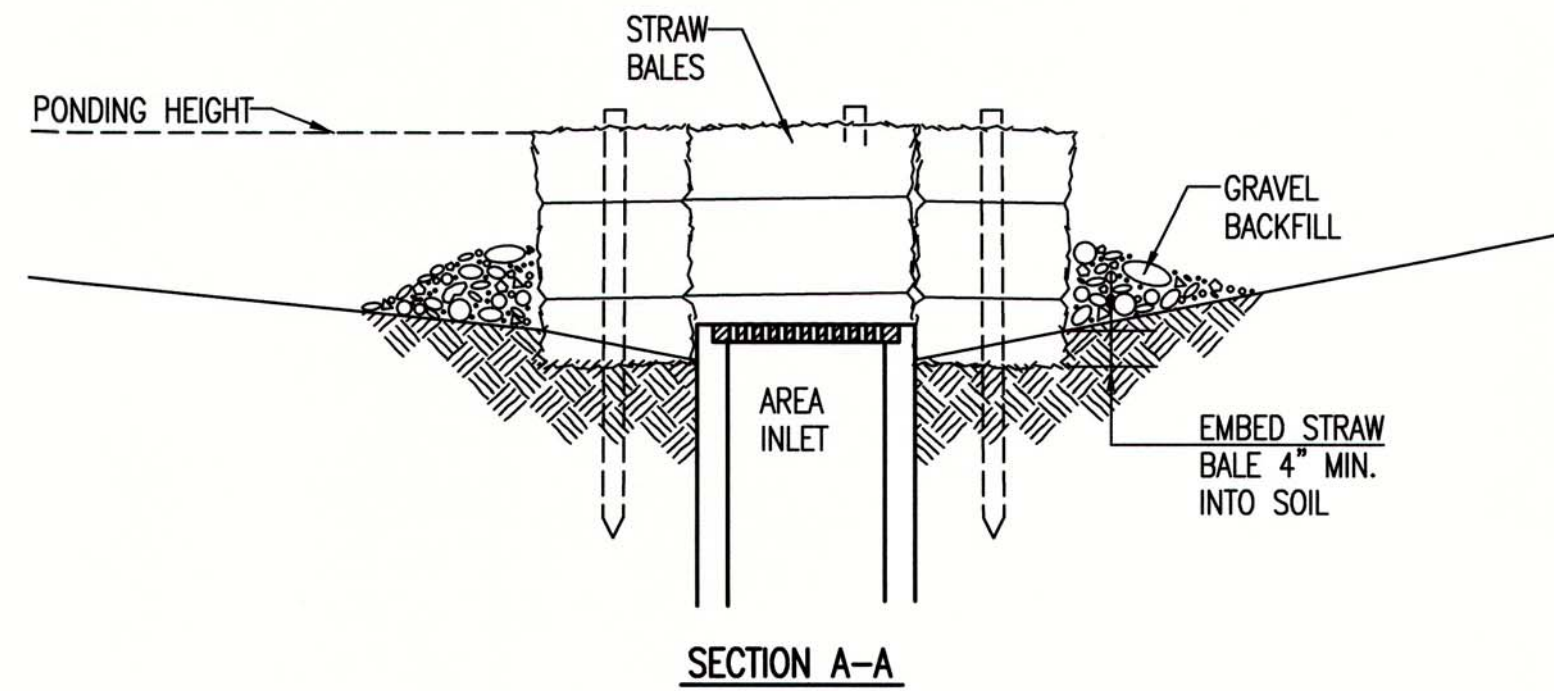

MATERIAL SPECIFICATION:

BALE AREA INLET BARRIERS SHOULD BE CONSTRUCTED OF WHEAT STRAW, OAT STRAW, PRAIRIE HAY, OR BROMEGRASS HAY THAT IS FREE OF WEEDS DECLARED NOXIOUS BY THE KANSAS STATE BOARD OF AGRICULTURE. THE STAKES USED TO ANCHOR THE BALES SHOULD BE A HARDWOOD MATERIAL WITH THE FOLLOWING MINIMUM DIMENSIONS: 2" SQUARE (NOMINAL) BY 4' LONG. TWINE SHOULD BE USED TO BIND BALES. THE USE OF WIRE BINDING IS PROHIBITED BECAUSE IT DOES NOT BIODEGRADE READILY.

PLACEMENT:

BALE AREA INLET BARRIERS SHOULD BE PLACED DIRECTLY AROUND THE PERIMETER OF A DROP INLET. WHEN A BALE AREA INLET BARRIER IS LOCATED NEAR AN INLET THAT HAS STEEP APPROACH SLOPES, THE STORAGE CAPACITY BEHIND THE BARRIER IS DRASTICALLY REDUCED. TIMELY REMOVAL OF SEDIMENT MUST OCCUR FOR A BARRIER TO OPERATE PROPERLY IN THIS LOCATION.

PROPER INSTALLATION METHOD:

EXCAVATE A TRENCH AROUND THE PERIMETER OF THE AREA INLET THAT IS AT LEAST 4" DEEP BY A BALE'S WIDTH WIDE. PLACE THE BALES IN THE TRENCH, MAKING SURE THAT THEY ARE BUTTED TIGHTLY. SOME BALES MAY NEED TO BE SHORTENED TO FIT INTO THE TRENCH AROUND THE AREA INLET. TWO STAKES SHOULD BE DRIVEN THROUGH EACH BALE, APPROXIMATELY 6" TO 8" IN FROM THE BALE ENDS. STAKES SHOULD BE DRIVEN AT LEAST 12" INTO THE GROUND. ONCE ALL THE BALES HAVE BEEN INSTALLED AND ANCHORED, PLACE THE EXCAVATED SOIL AGAINST THE RECEIVING SIDE OF THE BARRIER AND COMPACT IT. THE COMPACTED SOIL SHOULD BE NO MORE THAN 3" TO 4" DEEP. NOTE: WHEN A BALE AREA INLET BARRIER IS PLACED IN A SHALLOW MEDIAN DITCH, MAKE SURE THAT THE TOP OF THE BARRIER IS NOT HIGHER THAN THE PAVED ROAD. IN THIS CONFIGURATION, WATER MAY SPREAD ONTO THE ROADWAY CAUSING A HAZARDOUS CONDITION.

LIST OF COMMON PLACEMENT INSTALLATION MISTAKES TO AVOID:

BALES SHOULD BE PLACED DIRECTLY AGAINST THE PERIMETER OF THE AREA INLET. THIS ALLOWS OVERTOPPING WATER TO FLOW DIRECTLY INTO THE INLET INSTEAD OF ONTO NEARBY SOIL CAUSING SCOUR. BALE AREA INLET BARRIERS MUST BE DUG INTO THE GROUND. BALES AT GROUND LEVEL DO NOT WORK BECAUSE THEY ALLOW WATER TO FLOW UNDER THE BARRIER.

INSPECTION AND MAINTENANCE:

BALE AREA INLET BARRIERS SHOULD BE INSPECTED EVERY 7 DAYS AND WITHIN 24 HOURS OF A RAINFALL OF 1/2" OR MORE. THE FOLLOWING IS A LIST OF QUESTIONS THAT SHOULD BE ADDRESSED DURING EACH INSPECTION:

- DOES WATER FLOW UNDER THE AREA INLET BARRIER?
- DOES WATER FLOW THROUGH SPACES BETWEEN ABUTTING BALES?
- ARE ANY BALES DISLODGED?
- ARE BALES DECOMPOSING DUE TO AGE AND/OR WATER DAMAGE?
- DOES SEDIMENT NEED TO BE REMOVED FROM BEHIND THE AREA INLET BARRIER?

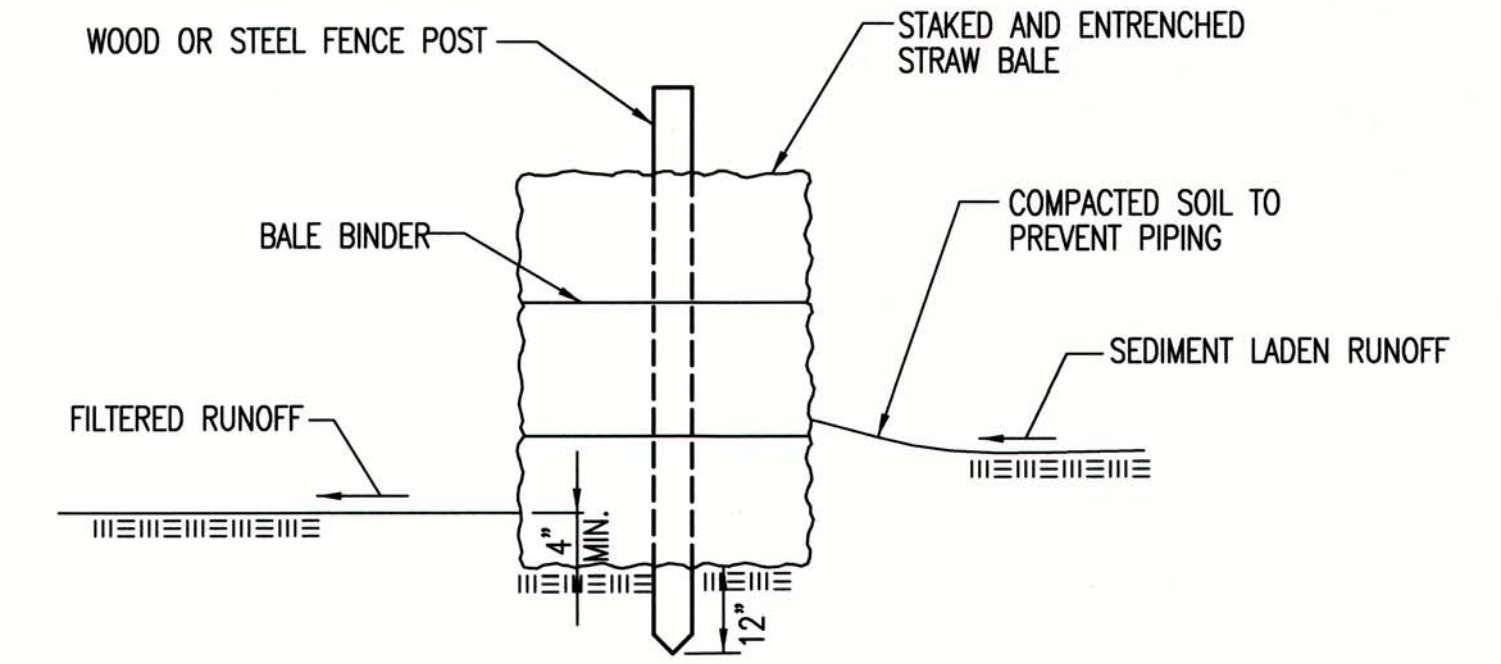

STRAW BALE BARRIERS

MATERIAL SPECIFICATION:

BALE SLOPE BARRIERS MAY BE CONSTRUCTED OF WHEAT STRAW, OAT STRAW, PRAIRIE HAY, OR BROMEGRASS HAY THAT IS FREE OF WEEDS DECLARED NOXIOUS BY THE KANSAS STATE BOARD OF AGRICULTURE. THE STAKES USED TO ANCHOR THE BALES SHOULD BE A HARDWOOD MATERIAL WITH THE FOLLOWING MINIMUM DIMENSIONS: 2" SQUARE (NOMINAL) BY 4' LONG. TWINE SHOULD BE USED TO BIND BALES. THE USE OF WIRE BINDING IS PROHIBITED BECAUSE IT DOES NOT BIODEGRADE READILY.

PLACEMENT:

A SLOPE BARRIER SHOULD BE USED AT THE TOE OF A SLOPE WHEN A DITCH DOES NOT EXIST. THE SLOPE BARRIER SHOULD BE PLACED ON NEARLY LEVEL GROUND 5' TO 10' AWAY FROM THE TOE OF A SLOPE. THE BARRIER IS PLACED AWAY FROM THE TOE OF THE SLOPE TO PROVIDE ADEQUATE STORAGE FOR SETTLING OUT SEDIMENT. WHEN PRACTICABLE, BALE SLOPE BARRIERS SHOULD BE PLACED ALONG CONTOURS TO AVOID A CONCENTRATION OF FLOW. BALE SLOPE BARRIERS CAN ALSO BE PLACED ALONG RIGHT-OF-WAY FENCE LINES TO KEEP SEDIMENT FROM CROSSING ONTO ADJACENT PROPERTY. WHEN PLACED IN THIS MANNER, THE SLOPE BARRIER WILL NOT LIKELY FOLLOW CONTOURS.

PROPER INSTALLATION METHOD:

EXCAVATE A TRENCH THE LENGTH OF THE PLANNED SLOPE BARRIER THAT IS 4" DEEP AND A BALE'S WIDTH WIDE. MAKE SURE THAT THE TRENCH IS EXCAVATED ALONG A SINGLE CONTOUR. WHEN PRACTICABLE, SLOPE BARRIERS SHOULD BE PLACED ALONG CONTOURS TO AVOID A CONCENTRATION OF FLOW. PLACE THE SOIL ON THE UPSLOPE SIDE OF THE TRENCH FOR LATER USE. PLACE THE BALES IN THE TRENCH, MAKING SURE THAT THEY ARE BUTTED TIGHTLY. TWO STAKES SHOULD BE DRIVEN THROUGH EACH BALE ALONG THE CENTERLINE OF THE DITCH CHECK, APPROXIMATELY 6" TO 8" IN FROM THE BALE ENDS. STAKES SHOULD BE DRIVEN AT LEAST 12" INTO THE GROUND. ONCE ALL THE BALES HAVE BEEN INSTALLED AND ANCHORED, PLACE THE EXCAVATED SOIL AGAINST THE UPSLOPE SIDE OF THE CHECK AND COMPACT IT. THE COMPACTED SOIL SHOULD BE NO MORE THAN 3" TO 4" DEEP.

LIST OF COMMON PLACEMENT/INSTALLATION MISTAKES TO AVOID:

WHEN PRACTICAL, DO NOT PLACE BALE SLOPE BARRIERS ACROSS CONTOURS. SLOPE BARRIERS SHOULD BE PLACED ALONG CONTOURS TO AVOID A CONCENTRATION OF FLOW. CONCENTRATED FLOW OVER A SLOPE BARRIER CREATES A SCOUR HOLE ON THE DOWNSLOPE SIDE OF THE BARRIER. THE SCOUR HOLE EVENTUALLY UNDERMINES THE BALES AND THE BARRIER FAILS. DO NOT PLACE BALE SLOPE BARRIERS IN AREAS WITH SHALLOW SOILS UNDERLAIN BY ROCK. IF THE BARRIER IS NOT ANCHORED SUFFICIENTLY, IT WILL WASH OUT. BALE SLOPE BARRIERS MUST BE DUG INTO THE GROUND. BALES AT GROUND LEVEL DO NOT WORK BECAUSE THEY ALLOW WATER TO FLOW UNDER THE BARRIER.

INSPECTION AND MAINTENANCE:

BALE SLOPE BARRIERS SHOULD BE INSPECTED EVERY 7 DAYS AND WITHIN 24 HOURS OF A RAINFALL OF 1/2" OR MORE. THE FOLLOWING IS A LIST OF QUESTIONS THAT SHOULD BE ADDRESSED DURING EACH INSPECTION:

- ARE THERE ANY POINTS ALONG THE SLOPE BARRIER WHERE WATER IS CONCENTRATING?
- DOES WATER FLOW UNDER THE SLOPE BARRIER?
- DOES WATER FLOW THROUGH SPACES BETWEEN ABUTTING BALES?
- ARE ANY BALES DISLODGED?
- ARE BALES DECOMPOSING DUE TO AGE AND/OR WATER DAMAGE?
- DOES SEDIMENT NEED TO BE REMOVED FROM BEHIND THE SLOPE BARRIER?

REVISION DATE: MAY 2013

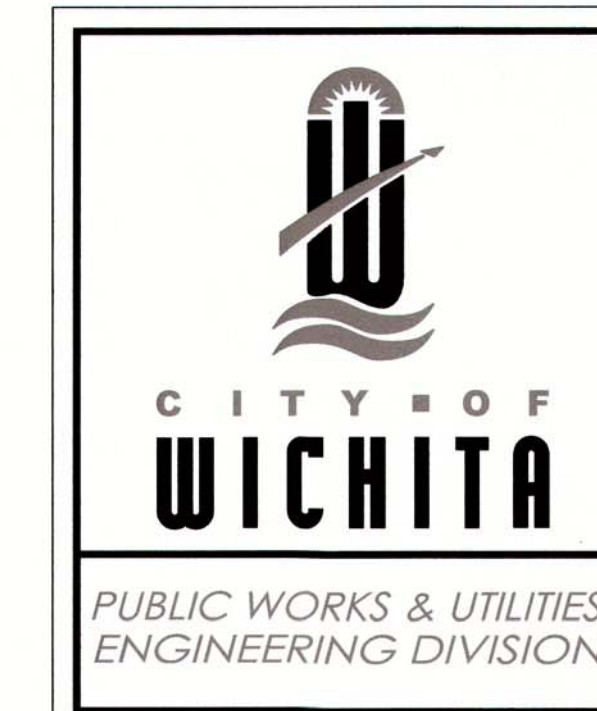

STRAW BALE DITCH CHECK AND BARRIER DETAILS

CITY ENGINEER GARY JANZEN, P.E.		
PROJECT NUMBER	OCA NUMBER	DATE
CITY ENGINEER'S OFFICE CITY HALL - SEVENTH FLOOR 455 NORTH MAIN STREET WICHITA, KANSAS 67202-1620 (316) 268-4501		SHEET 5.3

GENERAL NOTES

- THIS SHEET IS INTENDED TO PROVIDE GUIDELINES AS TO WHAT TYPES OF EROSION CONTROL DEVICES WILL BE INSTALLED DURING THE CONSTRUCTION PROCESS. CONTRACTORS ARE EXPECTED TO BID PROJECTS ACCORDINGLY.
- EROSION CONTROL DEVICES MUST BE MAINTAINED BY THE CONTRACTOR THROUGHOUT THE CONSTRUCTION PROCESS AND UNTIL THE DISTURBED EARTH IS RESTABILIZED.
- IF THE PROJECT WILL DISTURB 1 ACRE OR MORE, A FEDERAL/STATE NPDES STORMWATER PERMIT IS REQUIRED. A DETAILED STORMWATER POLLUTION PREVENTION PLAN, IS REQUIRED. THE EROSION CONTROL DEVICES SHOWN ON THIS SHEET ARE CONSIDERED TO BE THE MINIMUM TO BE SHOWN IN THE POLLUTION PREVENTION PLAN.
- FOR PROJECTS DISTURBING LESS THAN 1 ACRE, CONTRACTORS ARE ENCOURAGED TO PREPARE STORMWATER POLLUTION PREVENTION PLANS PRIOR TO CONSTRUCTION. EROSION CONTROL DEVICES MUST BE USED ON ALL PROJECTS.
- FAILURE TO USE AND MAINTAIN EROSION CONTROL DEVICES IS A VIOLATION OF SECTION 16.32 OF THE CITY CODE AND WILL SUBJECT THE CONTRACTOR TO THE PENALTIES PROVIDED FOR THEREIN.
- THE APPLICATION OF EROSION CONTROL DEVICES SHOWN ON THIS SHEET IS FOR SITUATIONS NORMALLY ENCOUNTERED. FROM TIME TO TIME, SITUATIONS WILL ARISE THAT MAY REQUIRE A DIFFERENT DEVICE OTHER THAN THOSE SHOWN. EROSION CONTROL DEVICES, OTHER THAN THOSE SHOWN, MAY BE UTILIZED AS LONG AS THEY ARE EFFECTIVE AND MAINTAINED.



GENERAL NOTES

- THE INTENT OF ALL EROSION CONTROL DEVICES IS TO KEEP ALL SEDIMENT CONFINED TO THE CONSTRUCTION SITE, AND OUT OF ALL UNDERGROUND PIPES, DITCHES, LAKES, AND OTHER DRAINAGE FACILITIES, AND OFF OF STREETS.
- THE POINT OF COMPLIANCE IS GENERALLY THE RIGHT-OF-WAY LINES WITHIN THE LIMITS OF CONSTRUCTION.
- EROSION CONTROL DEVICES WILL BE REQUIRED AT ALL POINTS ALONG THE PROJECT WHERE DISTURBED EARTH CAN DRAIN ONTO PRIVATE PROPERTY.
- INLET PROTECTION DEVICES WILL BE REQUIRED WHEREVER WATER CAN DRAIN OFF THE PROJECT SITE INTO AN INLET, INCLUDING ANY SIDE STREET INLETS.
- EROSION CONTROL DEVICES SHALL BE INSTALLED AT CREEK CROSSINGS SO AS TO PREVENT SEDIMENT FROM ENTERING THEREIN.
- STABILIZED CONSTRUCTION ENTRANCES SHALL BE PROVIDED, AS NEEDED, TO PREVENT MUD FROM TRACKING ONTO STREETS NOT UNDER CONSTRUCTION AND ON STREETS WITHIN THE PROJECT LIMITS IF TRAFFIC IS BEING MAINTAINED THROUGH THE PROJECT.
- ANY MUD TRACKED ONTO STREETS MUST BE REMOVED AT THE END OF EACH WORK DAY.
- THE CONTRACTOR WILL BE REQUIRED TO PLACE EROSION CONTROL DEVICES BACK OF CURB, WHENEVER WATER CAN DRAIN OVER CURB, TO KEEP ERODED SOIL OUT OF THE GUTTERLINES, IN ACCORDANCE WITH THE FOLLOWING:
 - THE DEVICE REQUIRED WILL BE APPROVED EROSION CONTROL MAT LISTED ON THE CITY'S APPROVED MATERIAL LIST. SAID BLANKET SHALL BE PLACED OVER THE APPROPRIATE SEED AND FERTILIZER, AS SPECIFIED IN THE PROJECT SPECIFICATIONS. (SEE SOIL EROSION BMPs - BACK OF CURB SEDIMENT BARRIER DETAILS)
 - THIS DEVICE SHALL BE INSTALLED IMMEDIATELY WHENEVER THE CURB IS BACKFILLED TO WITHIN 3" OF THE TOP OF CURB. (SEE CURB BACKFILL DETAIL) OTHER BMP'S MAY BE REQUIRED AT LOCATIONS WHERE CONCENTRATED FLOW CARRIES SEDIMENT OVER THE CURB.
 - ADDITIONALLY, OTHER EROSION CONTROL DEVICES (HAY BALES, SILT FENCE, ETC.) WILL BE INSTALLED AT LOCATIONS OF CONCENTRATED FLOW RESULTING IN SEDIMENT OVERRUNNING THE MAT.
 - SHOULD THE PROJECT PLANS SPECIFY THAT THE RIGHT-OF-WAY IS TO BE SODDED, THE EXCELSIOR MAT WILL NOT BE REQUIRED SO LONG AS THE SOD IS PLACED WITHIN 48 HOURS AFTER CURB BACKFILL REACHES A HEIGHT OF 3" OR LESS FROM TOP OF CURB. (SEE CURB BACKFILL DETAIL)

LEGEND

- R-O-W LIMITS
- DRAINAGE FLOW PATH
- x x x x x R/W LIMIT WITHIN CONSTRUCTION LIMIT
- STORM WATER INLETS
- IP INLET PROTECTION
- S,H SILT FENCE OR HAY BALE BARRIER
- SP STREAM PROTECTION
- SCE STABILIZED CONSTRUCTION ENTRANCE
- //// BACK OF CURB PROTECTION



CITY OF WICHITA
PUBLIC WORKS & UTILITIES
ENGINEERING DIVISION

REVISION: JUNE 2015		
STREET IMPROVEMENT PROJECTS		
CITY ENGINEER GARY JANZEN, P.E.		
PROJECT NUMBER 0320 PPD	OCA NUMBER 607861	DATE
CITY ENGINEER'S OFFICE CITY HALL - SEVENTH FLOOR 455 NORTH MAIN STREET WICHITA, KANSAS 67202-1620 (316) 268-4501		SHEET 5.4

PHASE 1 – INITIAL EARTHWORK AND UTILITIES (EXCEPT STORM SEWER)



1. DURING THIS PHASE OF SUBDIVISION CONSTRUCTION, THE POINTS OF COMPLIANCE ARE THE PERIMETER BOUNDARIES AND ANY DRAINAGE WAYS OR STORM SEWERS DRAINING THROUGH OR FROM THE SITE. SHOULD LAKES BE CONSTRUCTED WITHIN THE SUBDIVISION THAT WILL DISCHARGE DURING STORMS, THEY ARE ALSO A POINT OF COMPLIANCE.
2. HAY BALES OR SILT FENCE MUST BE CONSTRUCTED ALONG THE PROPERTY LINE WHERE ON SITE WATER CAN DRAIN OFF THE PROPERTY. THESE EROSION CONTROL DEVICES WILL ALSO BE INSTALLED ALONG ANY DRAINAGE DITCH OR LAKE THAT CAN DISCHARGE.
3. SHOULD SILT OR SEDIMENT ENTER THE DITCHES OR STREETS ON THE ADJACENT BOUNDARY STREETS, APPROPRIATE EROSION CONTROL DEVICES WILL BE PLACED WITHIN THE SUBDIVISION TO PREVENT THIS.
4. ANY MUD TRACKED ONTO ADJACENT STREETS WILL BE REMOVED WITHIN 48 HOURS OR BY FRIDAY AT 6:00 PM, WHICHEVER IS EARLIER.
5. CONTRACTORS WORKING WITHIN THE SITE WILL NOT BE REQUIRED TO USE INDIVIDUAL EROSION CONTROL DEVICES AS LONG AS THOSE SPECIFIED ABOVE ARE IN PLACE AND EFFECTIVE. CONTRACTORS WORKING ON THE BOUNDARY LINE STREETS OR ON ADJACENT PROPERTIES TO EXTEND UTILITIES ARE EXPECTED TO USE EROSION CONTROL DEVICES AT THEIR WORK LOCATIONS, AS NEEDED.
6. UTILIZE STABILIZED CONSTRUCTION ENTRANCE AT ENTRANCE AND EXIT ONTO ANY EXISTING PUBLIC STREETS.
7. IF THE INITIAL EARTH WORK AND UTILITIES ARE DONE AS PART OF A PUBLIC IMPROVEMENT PROJECT, THESE EROSION CONTROL DEVICES WILL BE INSTALLED BY THE CONTRACTOR AS SPECIFIED IN THE INDIVIDUAL PROJECT CONTRACTS. THE CONTRACTOR WILL MAINTAIN THE DEVICES UNTIL COMPLETION OF THE CONTRACT, AT WHICH TIME THE DEVELOPER WILL ASSUME MAINTENANCE RESPONSIBILITIES. IF THESE CONTRACTS ARE NOT PUBLIC IMPROVEMENT PROJECTS, THE DEVELOPER WILL BE RESPONSIBLE FOR INSTALLING AND MAINTAINING THESE DEVICES.
8. WITHIN 14 DAYS OF COMPLETION OF EARTHWORK ACTIVITIES IN ANY GIVEN AREA, THAT AREA SHALL BE TEMPORARILY OR PERMANENTLY SEEDED AND MULCHED.

PHASE 3 – STREET CONSTRUCTION

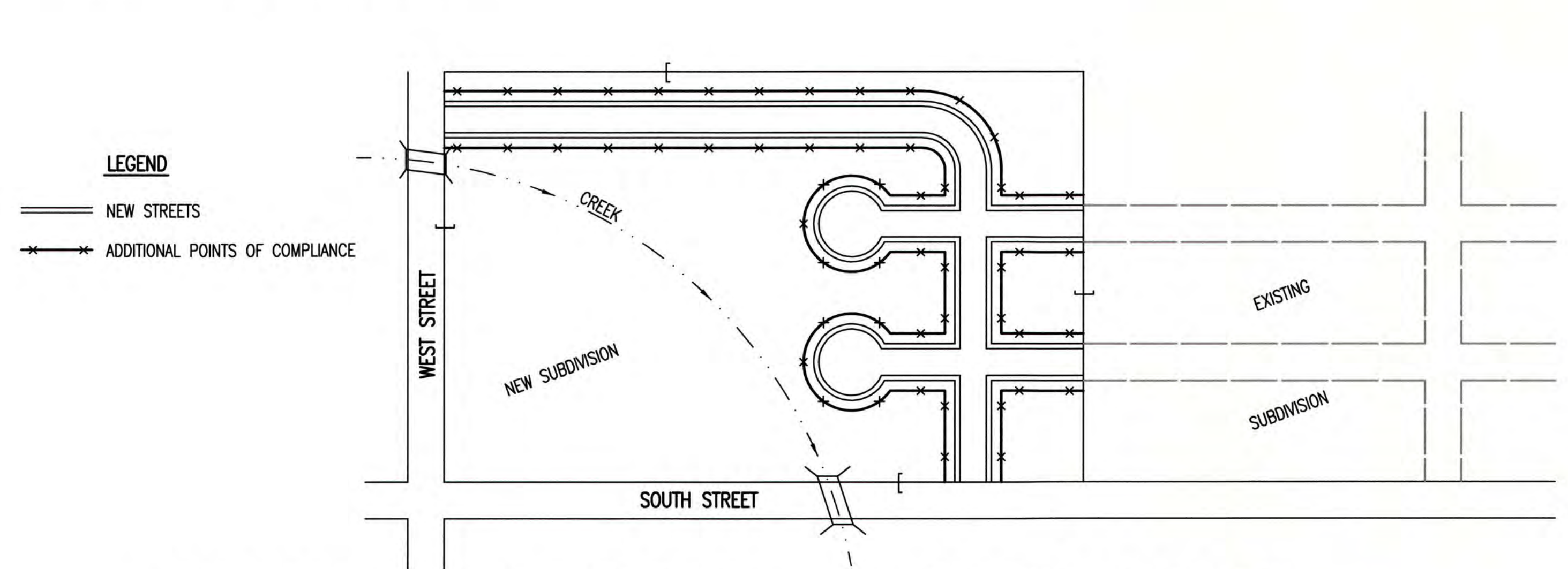

1. DURING THIS PHASE OF SUBDIVISION CONSTRUCTION, NEW STREETS ARE INSTALLED. ALL EROSION CONTROL DEVICES INSTALLED DURING PHASE 1 AND 2 MUST STILL BE MAINTAINED. THE POINT OF COMPLIANCE NOW SHIFTS TO THE BACK OF CURB ALONG EACH STREET.
2. CURB OPENING INLET PROTECTION:
 - A. SUMP AREAS – INLET PROTECTION SHALL BE PROVIDED WHEN STREET SUBGRADE WORK IS COMPLETED.
 - B. NON-SUMP LOCATIONS – PROVIDE INLET PROTECTION AS SOON AS BASE COURSE ASPHALT IS INSTALLED, BEFORE THE SURFACE COURSE LIFT.
3. EROSION CONTROL DEVICES WILL BE REQUIRED BACK OF CURB WHEREVER WATER CAN FLOW OVER THE CURB AND THE CURB HAS BEEN BACKFILLED TO WITHIN 3" OR LESS OF THE TOP OF CURB (SEE CURB BACKFILL DETAIL). FOR CURBS NOT YET ENTIRELY BACKFILLED (3" OR MORE BELOW TOP OF CURB), ADDITIONAL DEVICES WILL BE REQUIRED AT POINTS WHERE WATER BREAKS OVER CURB WHICH COULD RESULT IN THE PLACEMENT OF SEDIMENT IN THE GUTTER.
4. SEE DETAIL SHEET FOR BACK OF CURB PROTECTION.
5. THE BACK OF CURB PROTECTION SPECIFIED ON THIS PLAN MAY HAVE TO BE SUPPLEMENTED WITH HAY BALE OR SILT FENCE EROSION CONTROL DEVICES AT LOCATIONS WHERE CONCENTRATED FLOW RESULTS IN SEDIMENT BEING CARRIED OVER THE EXCELSIOR MATS.
6. THE STREET CONTRACTOR WILL BE RESPONSIBLE FOR INSTALLING BACK OF CURB EROSION CONTROL DEVICES.
7. THE INDIVIDUAL LOT OWNERS WILL BE RESPONSIBLE FOR MAINTAINING THE BACK OF CURB EROSION CONTROL DEVICES IN FRONT OF THEIR LOTS UNTIL SUCH TIME AS ADJACENT DISTURBED EARTH IS STABILIZED WITH GRASS OR SOD.

PHASE 2 – INSTALLATION OF STORM SEWER

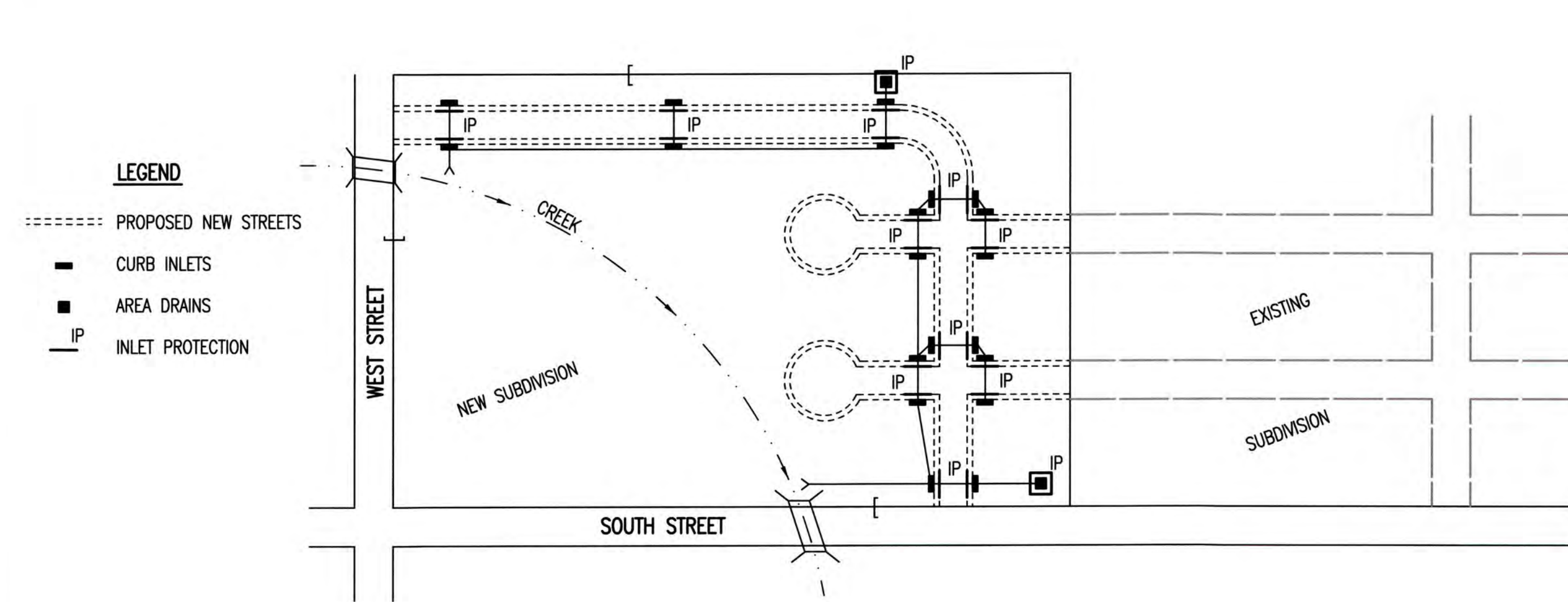

1. DURING THIS PHASE OF SUBDIVISION DEVELOPMENT, ALL EROSION CONTROL DEVICES REQUIRED IN PHASE 1 SHALL REMAIN IN PLACE AND BE MAINTAINED.
2. AS NEW STORM SEWERS, WITH INLETS, ARE INSTALLED, THE STORM SEWERS MUST NOW BE PROTECTED SO ALL NEW INLETS BECOME POINTS OF COMPLIANCE.
3. AREA DRAINS – AS SOON AS WATER CAN FLOW INTO THESE DRAINS, HAY BALE OR SILT FENCE PROTECTION WILL BE INSTALLED AROUND THEM.
4. CURB OPENING INLETS – AS SOON AS WATER CAN FLOW INTO THESE DRAINS, INLET PROTECTION DEVICES MUST BE INSTALLED. IF WATER CANNOT FLOW INTO CURB INLETS UNTIL STREET CONSTRUCTION IS COMPLETE, THEN STREET CONTRACTOR WILL INSTALL INLET PROTECTION. SEE PHASE 3 – STREET CONSTRUCTION.
5. THE STORM SEWER CONTRACTOR WILL BE RESPONSIBLE FOR INSTALLING THESE DEVICES.
6. THE SUBDIVISION DEVELOPER WILL MAINTAIN THESE EROSION CONTROL DEVICES ONCE INSTALLED.
7. ALL DISTURBED GROUND WILL BE FINAL GRADED AND TEMPORARILY OR PERMANENTLY SEEDED WITHIN 14 DAYS IF COMPLETION OF WORK IN ANY GIVEN PART OF THE SUBDIVISION.
8. ONCE ALL DISTURBED GROUND DRAINING TO AN INLET HAS BEEN RESTABILIZED WITH GRASS OR SOD, THE SUBDIVISION DEVELOPER WILL BE RESPONSIBLE FOR PERMANENTLY REMOVING THE INLET PROTECTION.

GENERAL NOTES

1. THE INTENT OF ALL EROSION CONTROL DEVICES IS TO PREVENT ERODED SOIL FROM ENTERING DITCHES, STORM SEWERS, LAKES, STREETS OR ANY OTHER OTHER DRAINAGE FEATURE.
2. THIS SHEET IS INTENDED TO PROVIDE GUIDELINES AS TO WHAT TYPE OF EROSION CONTROL DEVICES WILL BE INSTALLED DURING THE CONSTRUCTION PROCESS. CONTRACTORS ARE EXPECTED TO BID PROJECTS ACCORDINGLY.
3. EROSION CONTROL DEVICES SHALL BE MAINTAINED DURING THE CONSTRUCTION PROCESS TO REMAIN EFFECTIVE. MAINTENANCE SHALL BE AS INDICATED ON SOIL EROSION BMP'S DETAIL SHEETS.
4. PERSONS DESTROYING EROSION CONTROL DEVICES SHALL BE RESPONSIBLE FOR IMMEDIATELY REPAIRING THEM OR INSTALLING SUITABLE REPLACEMENT DEVICES.
5. THE DEVELOPMENT OF ANY SUBDIVISION THAT DISTURBS 1 ACRE OR MORE WILL REQUIRE A FEDERAL/STATE NPDES STORMWATER PERMIT. THE PREPARATION OF A STORMWATER POLLUTION PREVENTION PLAN IS REQUIRED. EROSION CONTROL DEVICES ARE REQUIRED. THE DETAILS SHOWN ON THIS SHEET ARE THE MINIMUM STANDARDS TO BE SHOWN ON POLLUTION PREVENTION PLANS.
6. FOR SUBDIVISIONS SMALLER THAN 1 ACRE, SOIL EROSION DEVICES ARE REQUIRED. ALSO, DEVELOPERS AND CONTRACTORS ARE ENCOURAGED TO DEVELOP POLLUTION PREVENTION PLANS FOR EACH PROJECT PRIOR TO CONSTRUCTION.
7. FAILURE TO USE AND MAINTAIN SOIL EROSION DEVICES IS A VIOLATION OF SECTION 16.32 OF THE CITY CODE AND WILL SUBJECT THE SUBDIVISION DEVELOPER AND CONTRACTORS TO THE PENALTIES PROVIDED THEREIN.
8. THE APPLICATION OF EROSION CONTROL DEVICES SHOWN ON THIS SHEET IS FOR SITUATIONS NORMALLY ENCOUNTERED. FROM TIME TO TIME, SITUATIONS WILL ARISE THAT MAY REQUIRE DEVICES OTHER THAN THAT SHOWN. EROSION CONTROL DEVICES, OTHER THAN THOSE SHOWN, MAY BE UTILIZED SO LONG AS THEY ARE EFFECTIVE AND MAINTAINED.
9. A STABILIZED EARTH SURFACE IS DEFINED AS ONE THAT IS HARD SURFACED WITH CONCRETE, ASPHALT, OR THE LIKE, OR ONE ON WHICH 70% OF THE GRASS HAS GERMINATED ON THE ENTIRE SURFACE.

SEE DETAIL SHEET FOR BACK OF CURB PROTECTION DETAIL

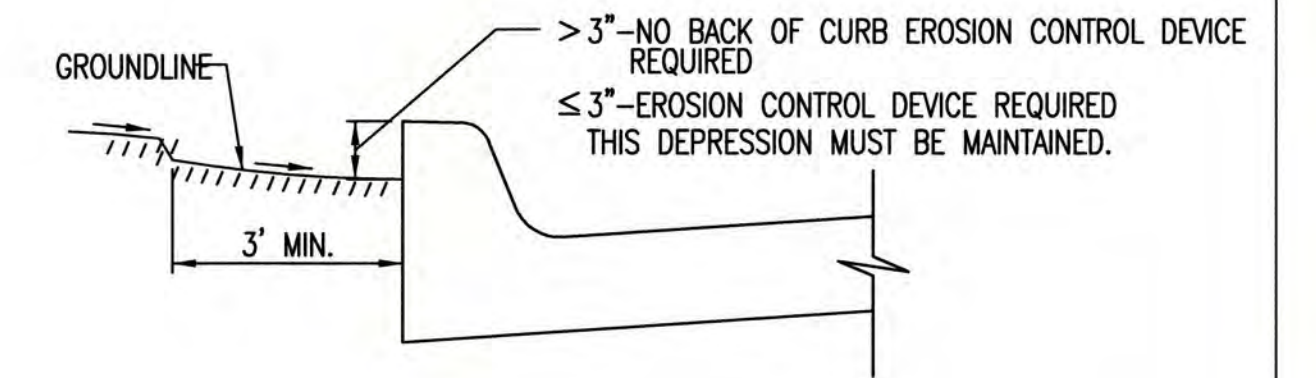

CURB BACKFILL DETAIL (STREET CONSTRUCTION ONLY)

THIS IS A TEMPORARY MEASURE ONLY, WHEN APPROVED BY THE PROJECT ENGINEER. THE DIRT GRADE BEHIND THE CURB SHALL BE BROUGHT TO THE TOP OF CURB, WITH TEMPORARY EROSION CONTROL MAT OR PERMANENT VEGETATION PLACED, PRIOR TO THE COMPLETION OF ALL PROJECTS.

REVISION DATE: MAY 2013



CITY OF WICHITA
PUBLIC WORKS & UTILITIES ENGINEERING DIVISION

SUBDIVISION DEVELOPMENT PROCESS		
CITY ENGINEER GARY JANZEN, P.E.		
PROJECT NUMBER	OCA NUMBER	DATE
CITY ENGINEER'S OFFICE CITY HALL - SEVENTH FLOOR 455 NORTH MAIN STREET WICHITA, KANSAS 67202-1620 (316) 268-4501		SHEET 5.5

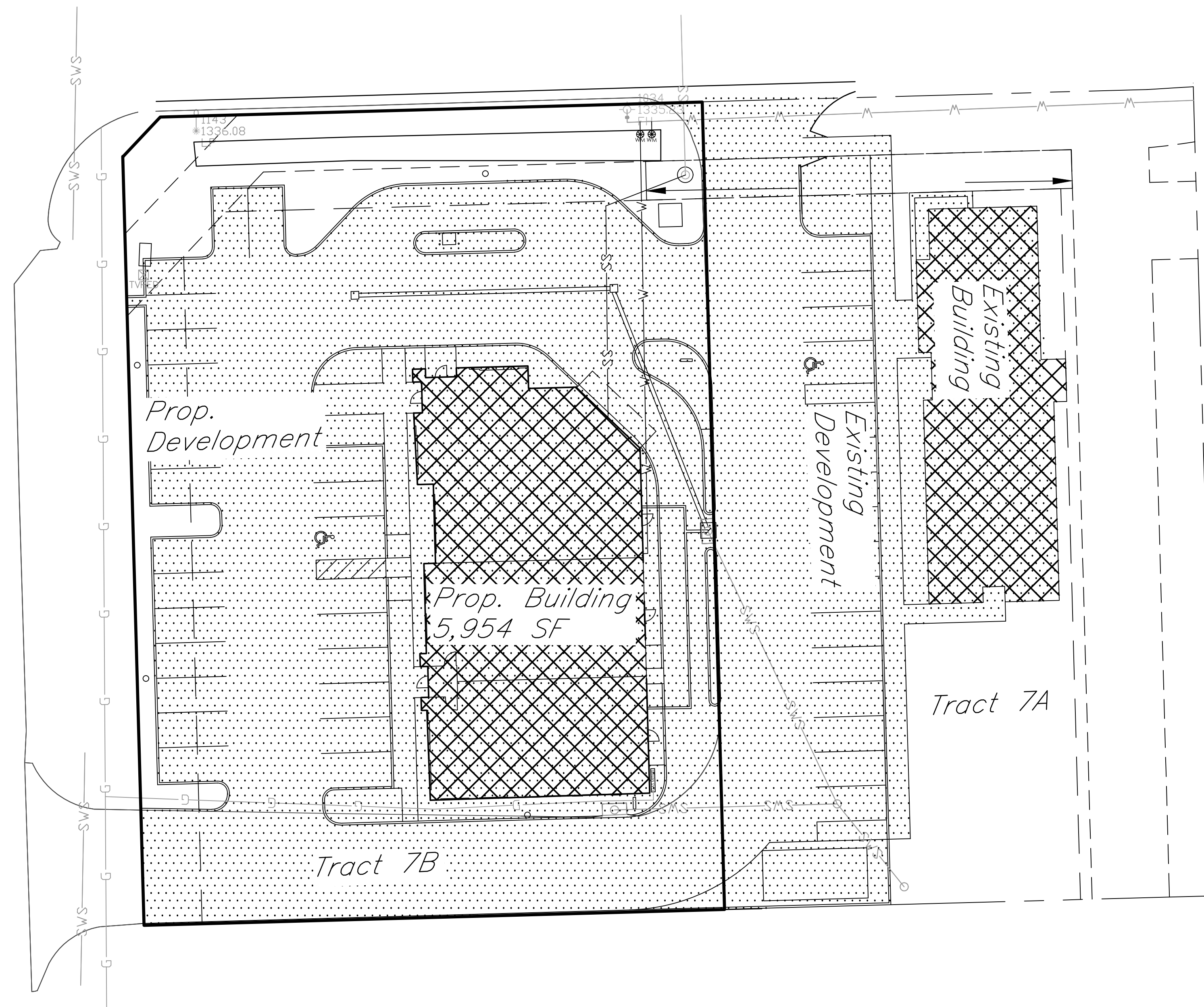

Legal Description:

Lot 7 Block 1 Estancia
Commercial Addition
Except the east 127'
thereof

ERU Calculations:

Ex. Impervious Area =
4,226 sq. ft.

Total Lot Area =
31,267 sq. ft.

Proposed Building Area =
5,954 sq. ft.

Total Impervious Area =
26,684 sq. ft.
(Post Construction)

Net Increase in Impervious
Area = 22,458 sq. ft.

Hatching Legend:

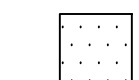
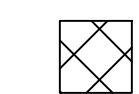
-  Parking, Sidewalks, and
Other Impervious Area
-  Building Area

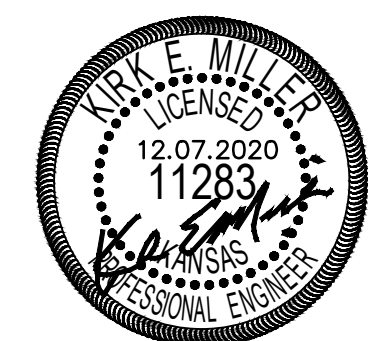

THIS SHEET HAS BEEN
SIGNED, SEALED AND
DATED DIGITALLY



HORIZONTAL SCALE
(IN FEET)
1 inch = 20 ft.

Estancia
ERU Plan
Wichita, Kansas

 117 E. Lewis, Wichita, KS 67202 (316)264-0242	PROJECT NUMBER 654 PPD (133119)			SHEET 6.0
	KEM NO. 20099	FILE	DATE 10/2020	
DESIGN KM	DRAWN PG	REVISED		