

FHWA REGION NO.	STATE	PROJECT NO.	YEAR	SHEET NO.	TOTAL SHEETS
7	KS	87N-0211-01	2000	13	44

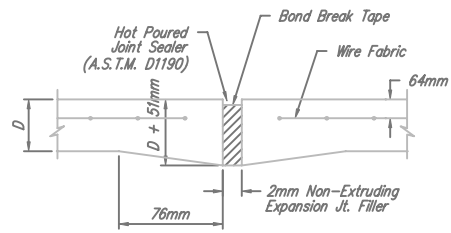

**EXPANSION JOINT**

NOTE: Extra Thickness to be Subsidiary to Price of Square Yards Pavement

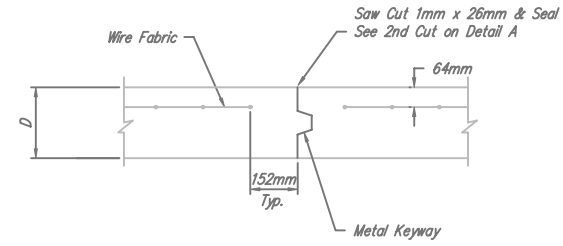

**OPTIONAL CONTRACTION JOINT**

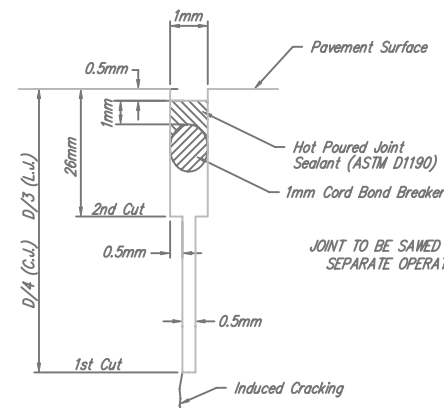

**SAW JOINT DETAIL**

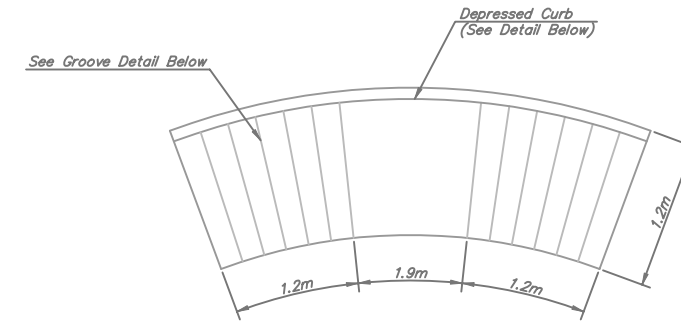

**WHEELCHAIR RAMP DETAIL**

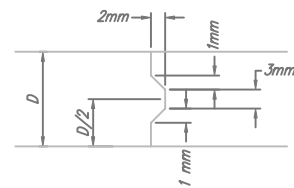

**KEYWAY DETAIL**

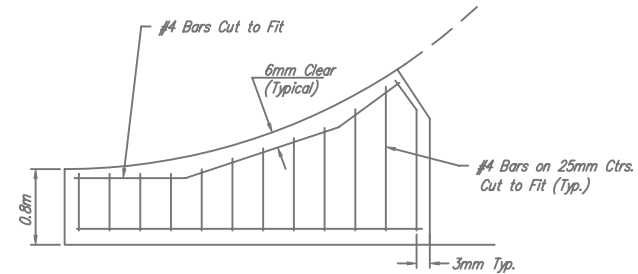

**WING REINFORCING DETAIL**

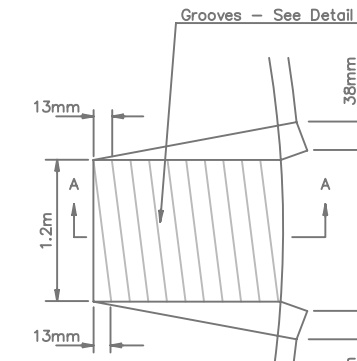

**WHEELCHAIR RAMP PLAN VIEW**

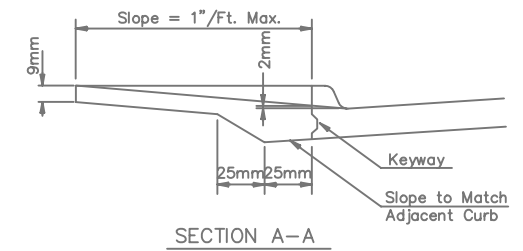

**SECTION A-A**

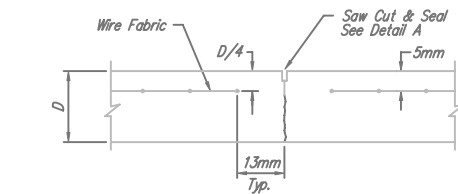

**CONTRACTION JOINT DETAIL (C.J.)**

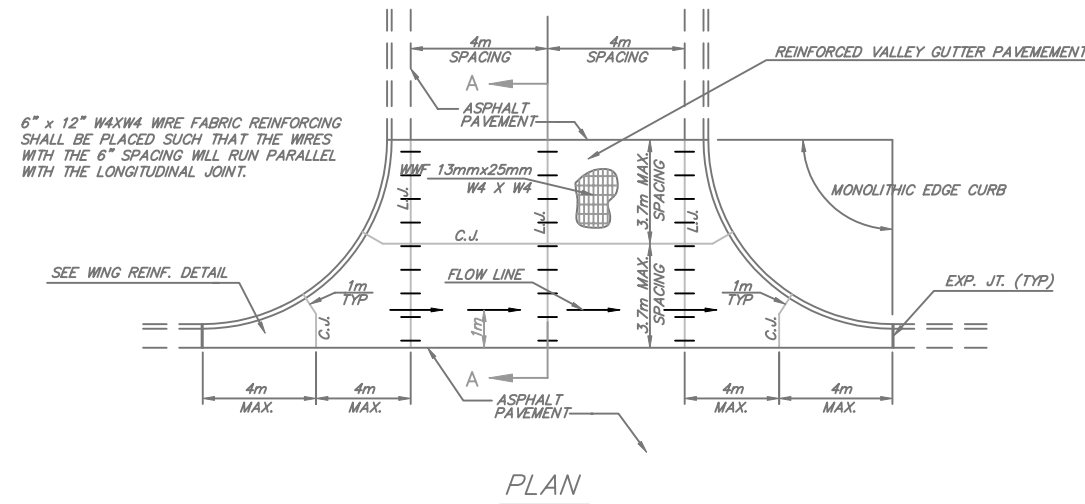

**PLAN**

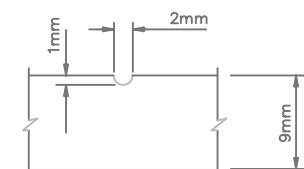

**GROOVE DETAIL**

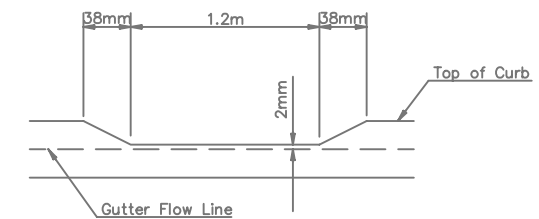

**DEPRESSED CURB DETAIL**

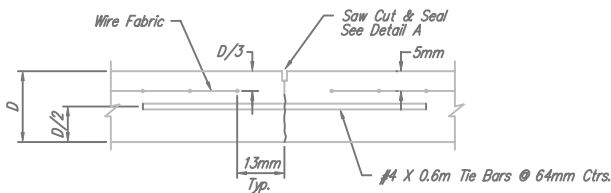

**LONGITUDINAL JOINT DETAIL (L.J.)**

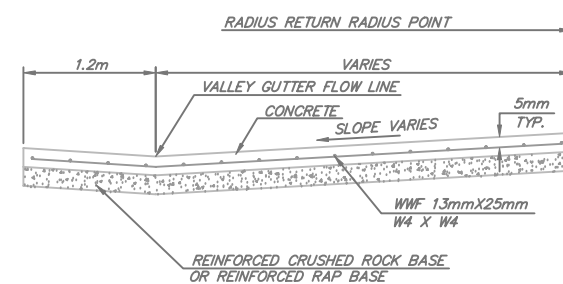

**SECTION A-A**

**REINFORCED VALLEY GUTTER DETAIL**

**STANDARD WHEELCHAIR RAMP DETAIL**

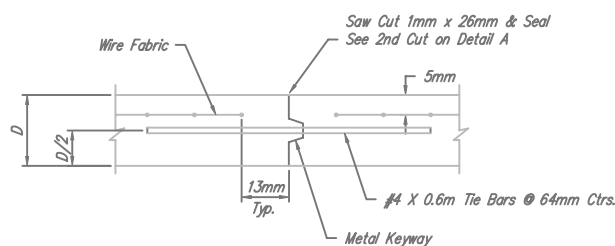

**OPTIONAL LONGITUDINAL JOINT DETAIL (L.J.)**

<p>THE CITY OF WICHITA</p> <p>CITY ENGINEER'S OFFICE CITY HALL - SEVENTH FLOOR 425 NORTH MAIN STREET WICHITA, KANSAS 67202 (316) 268-6801 (316) 268-4114 FAX</p>	<b>VALLEY GUTTER DETAILS</b> <b>WHEELCHAIR RAMP DETAILS</b>	
	M. E. LINDEBAK P.E. - CITY ENGINEER	
	PROJECT NUMBER XXX-XXXXX	INDEX CODE XXXXXX
	DATE MAR 96	SHEET OF