

PHASE 1 – INITIAL EARTHWORK AND UTILITIES (EXCEPT STORM SEWER)

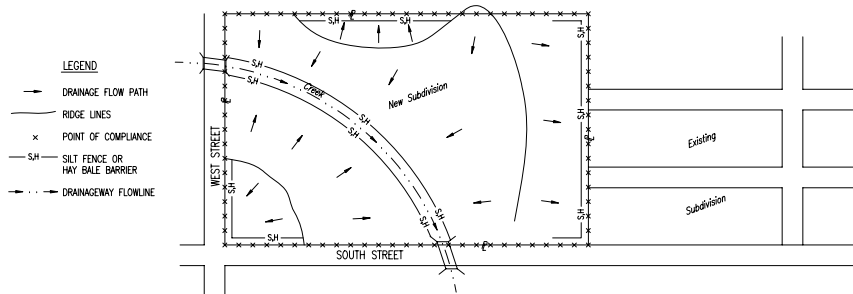

- DURING THIS PHASE OF SUBDIVISION CONSTRUCTION, THE POINTS OF COMPLIANCE ARE THE PERIMETER BOUNDARIES AND ANY DRAINAGE WAYS OR STORM SEWERS DRAINING THROUGH OR FROM THE SITE. SHOULD LAKES BE CONSTRUCTED WITHIN THE SUBDIVISION THAT WILL DISCHARGE DURING STORMS, THEY ARE ALSO A POINT OF COMPLIANCE.
- HAY BALES OR SILT FENCE MUST BE CONSTRUCTED ALONG THE PROPERTY LINE WHERE ON SITE WATER CAN DRAIN OFF THE PROPERTY. THESE EROSION CONTROL DEVICES WILL ALSO BE INSTALLED ALONG ANY DRAINAGE DITCH OR LAKE THAT CAN DISCHARGE.
- SHOULD SILT OR SEDIMENT ENTER THE DITCHES OR STREETS ON THE ADJACENT BOUNDARY STREETS, APPROPRIATE EROSION CONTROL DEVICES WILL BE PLACED WITHIN THE SUBDIVISION TO PREVENT THIS.
- ANY MUD TRACKED ONTO ADJACENT STREETS WILL BE REMOVED WITHIN 48 HOURS OR BY FRIDAY AT 6:00 PM, WHICHEVER IS EARLIER.
- CONTRACTORS WORKING WITHIN THE SITE WILL NOT BE REQUIRED TO USE INDIVIDUAL EROSION CONTROL DEVICES AS LONG AS THOSE SPECIFIED ABOVE ARE IN PLACE AND EFFECTIVE. CONTRACTORS WORKING ON THE BOUNDARY LINE STREETS OR ON ADJACENT PROPERTIES TO EXTEND UTILITIES ARE EXPECTED TO USE EROSION CONTROL DEVICES AT THEIR WORK LOCATIONS, AS NEEDED.
- UTILIZE STABILIZED CONSTRUCTION ENTRANCE AT ENTRANCE AND EXIT ONTO ANY EXISTING PUBLIC STREETS.
- IF THE INITIAL EARTH WORK AND UTILITIES ARE DONE AS PART OF A PUBLIC IMPROVEMENT PROJECT, THESE EROSION CONTROL DEVICES WILL BE INSTALLED BY THE CONTRACTOR AS SPECIFIED IN THE INDIVIDUAL PROJECT CONTRACTS. THE CONTRACTOR WILL MAINTAIN THE DEVICES UNTIL COMPLETION OF THE CONTRACT, AT WHICH TIME THE DEVELOPER WILL ASSUME MAINTENANCE RESPONSIBILITIES. IF THESE CONTRACTS ARE NOT PUBLIC IMPROVEMENT PROJECTS, THE DEVELOPER WILL BE RESPONSIBLE FOR INSTALLING AND MAINTAINING THESE DEVICES.
- WITHIN 14 DAYS OF COMPLETION OF EARTHWORK ACTIVITIES IN ANY GIVEN AREA, THAT AREA SHALL BE TEMPORARILY OR PERMANENTLY SEEDED OR MULCHED.

PHASE 3 – STREET CONSTRUCTION

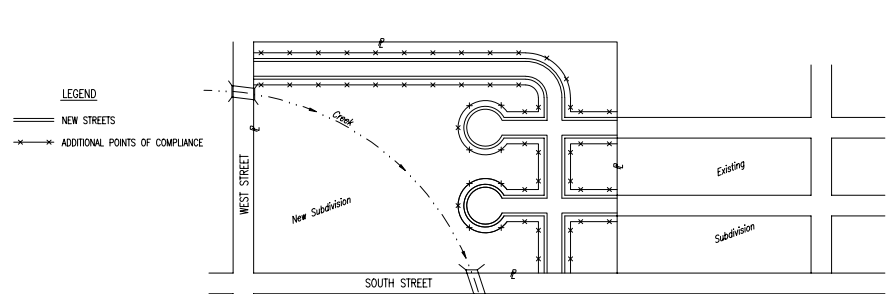

- DURING THIS PHASE OF SUBDIVISION CONSTRUCTION, NEW STREETS ARE INSTALLED. ALL EROSION CONTROL DEVICES INSTALLED DURING PHASE 1 AND 2 MUST STILL BE MAINTAINED. THE POINT OF COMPLIANCE NOW SHIFTS TO THE BACK OF CURB ALONG EACH STREET.
- CURB OPENING INLET PROTECTION:
 - SUMP AREAS – INLET PROTECTION SHALL BE PROVIDED WHEN STREET SUBGRADE WORK IS COMPLETED.
 - NON-SUMP LOCATIONS – PROVIDE INLET PROTECTION AS SOON AS BASE COURSE ASPHALT IS INSTALLED, BEFORE THE SURFACE COURSE LIFT.
- EROSION CONTROL DEVICES WILL BE REQUIRED BACK OF CURB WHENEVER WATER CAN FLOW OVER THE CURB AND THE CURB HAS BEEN BACKFILLED TO WITHIN 3" OR LESS OF THE TOP OF CURB (SEE CURB BACKFILL DETAIL). FOR CURBS NOT YET ENTIRELY BACKFILLED (3" OR MORE BELOW TOP OF CURB), ADDITIONAL DEVICES WILL BE REQUIRED AT POINTS WHERE WATER BREAKS OVER CURB WHICH COULD RESULT IN THE PLACEMENT OF SEDIMENT IN THE GUTTER.
- SEE DETAIL SHEET FOR BACK OF CURB PROTECTION.
- THE BACK OF CURB PROTECTION SPECIFIED ON THIS PLAN MAY HAVE TO BE SUPPLEMENTED WITH HAY BALE OR SILT FENCE EROSION CONTROL DEVICES AT LOCATIONS WHERE CONCENTRATED FLOW RESULTS IN SEDIMENT BEING CARRIED OVER THE EXCESSOR MATS.
- THE STREET CONTRACTOR WILL BE RESPONSIBLE FOR INSTALLING BACK OF CURB EROSION CONTROL DEVICES.
- THE INDIVIDUAL LOT OWNERS WILL BE RESPONSIBLE FOR MAINTAINING THE BACK OF CURB EROSION CONTROL DEVICES IN FRONT OF THEIR LOTS UNTIL SUCH TIME AS ADJACENT DISTURBED EARTH IS STABILIZED WITH GRASS OR SOO.

PHASE 2 – INSTALLATION OF STORM SEWER

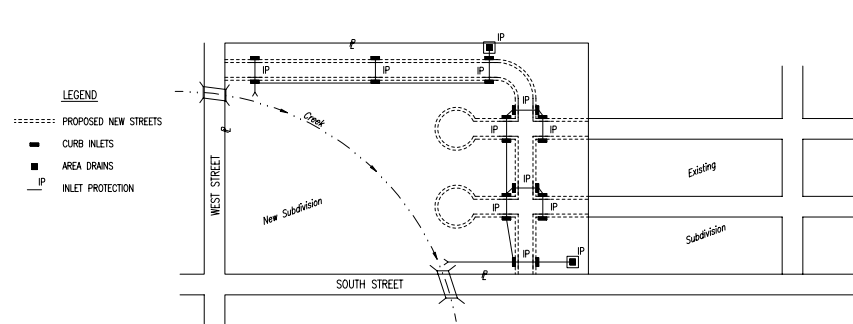

- DURING THIS PHASE OF SUBDIVISION DEVELOPMENT, ALL EROSION CONTROL DEVICES REQUIRED IN PHASE 1 SHALL REMAIN IN PLACE AND BE MAINTAINED.
- AS NEW STORM SEWERS WITH INLETS ARE INSTALLED, THE STORM SEWERS MUST NOW BE PROTECTED SO ALL NEW INLETS BECOME POINTS OF COMPLIANCE.
- AREA DRAINS – AS SOON AS WATER CAN FLOW INTO THESE DRAINS, HAY BALE OR SILT FENCE PROTECTION WILL BE INSTALLED AROUND THEM.
- CURB OPENING INLETS – AS SOON AS WATER CAN FLOW INTO THESE DRAINS, INLET PROTECTION DEVICES MUST BE INSTALLED. IF WATER CANNOT FLOW INTO CURB INLETS UNTIL STREET CONSTRUCTION IS COMPLETE, THEN STREET CONTRACTOR WILL INSTALL INLET PROTECTION. SEE PHASE 3 – STREET CONSTRUCTION.
- THE STORM SEWER CONTRACTOR WILL BE RESPONSIBLE FOR INSTALLING THESE DEVICES.
- THE SUBDIVISION DEVELOPER WILL MAINTAIN THESE EROSION CONTROL DEVICES ONCE INSTALLED.
- ALL DISTURBED GROUND WILL BE FINAL GRADED AND TEMPORARILY OR PERMANENTLY SEEDED WITHIN 14 DAYS OF COMPLETION OF WORK IN ANY GIVEN PART OF THE SUBDIVISION.
- ONCE ALL DISTURBED GROUND DRAINING TO AN INLET HAS BEEN RESTABILIZED WITH GRASS OR SOO, THE SUBDIVISION DEVELOPER WILL BE RESPONSIBLE FOR PERMANENTLY REMOVING THE INLET PROTECTION.

GENERAL NOTES:

- THE INTENT OF ALL EROSION CONTROL DEVICES IS TO PREVENT ERODED SOIL FROM ENTERING DITCHES, STORM SEWERS, LAKES, STREETS OR ANY OTHER OTHER DRAINAGE FEATURE.
- THIS SHEET IS INTENDED TO PROVIDE GUIDELINES AS TO WHAT TYPE OF EROSION CONTROL DEVICES WILL BE INSTALLED DURING THE CONSTRUCTION PROCESS. CONTRACTORS ARE EXPECTED TO BID PROJECTS ACCORDINGLY.
- EROSION CONTROL DEVICES SHALL BE MAINTAINED DURING THE CONSTRUCTION PROCESS TO REMAIN EFFECTIVE. MAINTENANCE SHALL BE AS INDICATED ON SOIL EROSION BMP'S DETAIL SHEETS.
- PERSONS DESTROYING EROSION CONTROL DEVICES SHALL BE RESPONSIBLE FOR IMMEDIATELY REPAIRING THEM OR INSTALLING SUITABLE REPLACEMENT DEVICES.
- THE DEVELOPMENT OF ANY SUBDIVISION THAT DISTURBS 1 ACRE OR MORE WILL REQUIRE A FEDERAL/STATE NPDES STORMWATER PERMIT. THE PREPARATION OF A STORMWATER POLLUTION PREVENTION PLAN IS REQUIRED. EROSION CONTROL DEVICES ARE REQUIRED. THE DETAILS SHOWN ON THIS SHEET ARE THE MINIMUM STANDARDS TO BE SHOWN ON POLLUTION PREVENTION PLANS.
- FOR SUBDIVISIONS SMALLER THAN 1 ACRE, SOIL EROSION DEVICES ARE REQUIRED. ALSO, DEVELOPERS AND CONTRACTORS ARE ENCOURAGED TO DEVELOP POLLUTION PREVENTION PLANS FOR EACH PROJECT PRIOR TO CONSTRUCTION.
- FAILURE TO USE AND MAINTAIN SOIL EROSION DEVICES IS A VIOLATION OF SECTION 16.32 OF THE CITY CODE AND WILL SUBJECT THE SUBDIVISION DEVELOPER AND CONTRACTORS TO THE PENALTIES PROVIDED THEREIN.
- THE APPLICATION OF EROSION CONTROL DEVICES SHOWN ON THIS SHEET IS FOR SITUATIONS NORMALLY ENCOUNTERED. FROM TIME TO TIME, SITUATIONS WILL ARISE THAT MAY REQUIRE DEVICES OTHER THAN THAT SHOWN. EROSION CONTROL DEVICES, OTHER THAN THOSE SHOWN, MAY BE UTILIZED SO LONG AS THEY ARE EFFECTIVE AND MAINTAINED.
- A STABILIZED EARTH SURFACE IS DEFINED AS ONE THAT IS HARD SURFACED WITH CONCRETE, ASPHALT, OR THE LIKE, OR ONE ON WHICH 70% OF THE GRASS HAS GERMINATED ON THE ENTIRE SURFACE.

SEE DETAIL SHEET FOR BACK OF CURB PROTECTION DETAIL

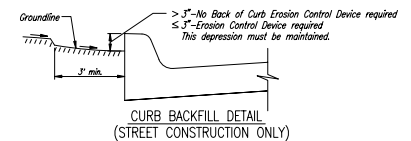

SOIL EROSION BMPs

SUBDIVISION DEVELOPMENT PROCESS

JIM ARMOUR, P.E.
CITY ENGINEER

PROJECT NUMBER	OGA NO.
DATE	
JAN. 2007	SHEET ___ OF ___

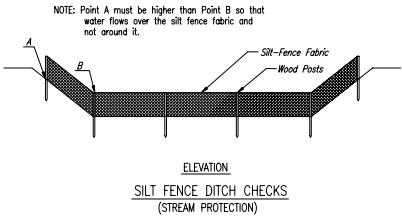

Material Specification:
Silt fence fabric should conform to the AASHTO M288 96 silt fence specification. The posts used to support the silt fence fabric should be a hardwood material with the following minimum dimensions: 2" square (nominal) by 4' long. Silt fence fabric should be attached to the wooden posts with staples, wire, zip ties, or nails.

Placement:
Place silt fence in ditches where it is unlikely that it will be overtopped. Water should flow through a silt fence ditch check, not over it. Silt fence ditch checks often fail when overtopped. Silt fence ditch checks should be placed perpendicular to the flowline of the ditch. The silt fence should extend far enough so that the ground level at the ends of the fence is higher than the top of the low point of the fence. This prevents water from flowing around the check. Silt fence ditch checks should not be placed in ditches where high flows are expected. Rock checks should be used instead for slopes of 6% or less. Silt fence should be placed in ditches with slopes of 6% or less. For slopes steeper than 6%, rock checks should be used.

The following table provides check spacing for a given ditch grade:

Ditch Check Spacing (%)	Ditch grade Check Spacing (feet)
0.5	200
1.0	200
2.0	100
3.0	65
4.0	50
5.0	40
6.0	30

Proper installation method:
Excavate a trench perpendicular to the ditch flowline that is at least 12" deep by 6" wide. Extend the trench in a straight line along the entire length of the proposed ditch check. Place the soil on the upstream side of the trench for later use. Roll out a continuous length of silt fence fabric on the downstream side of the trench. Place the edge of the fabric in the trench starting at the top upstream edge of the trench. Line two sides of the trench with the fabric as shown on detail. Backfill over the fabric in the trench with the excavated soil and compact. After filling the trench, approximately 24" to 36" of silt fence fabric should remain exposed. Lay the exposed silt fence on the upstream side of the trench to clear an area for driving in the posts. Just downstream of the trench, drive posts into the ground to a depth of at least 24". Place posts no more than 4' apart. Attach the silt fence to the anchored post with staples, wire, zip ties, or nails.

List of common placement/installation mistakes to avoid:
Water should flow through a silt fence ditch check—not over it. Place silt fence in ditches where it is unlikely that it will be overtopped. Silt fence installations quickly deteriorate when water overtops them. Do not place silt fence posts on the upstream side of the silt fence fabric. In this configuration, the force of the water is not restricted by the posts, but only by the staples (wire, zip ties, nails, etc.). The silt fence will rip and fail. Do not place a silt fence ditch check directly in front of a culvert outlet. It will not stand up to the concentrated flow. Do not place silt fence ditch checks in ditches that will likely experience high flows. They will not stand up to concentrated flow. Follow prescribed ditch check spacing guidelines. If spacing guidelines are exceeded, erosion will occur between the ditch checks. Do not allow water to flow around the ditch check. Make sure that the ditch check is long enough so that the ground level at the ends of the fence is higher than the low point on top of the fence. Do not place silt fence ditch checks in channels with shallow soils underlain by rock. If the check is not anchored sufficiently, it will wash out.

Inspection and Maintenance:
Silt fence ditch checks should be inspected every 7 days and within 24 hours of a rainfall of 1/2" or more. The following is a list of questions that should be addressed during each inspection:
Does water flow around the ditch check?
Does water flow under the ditch check?
Does the silt fence sag excessively?
Has the silt fence torn or become detached from the posts?
Does sediment need to be removed from behind the ditch check?

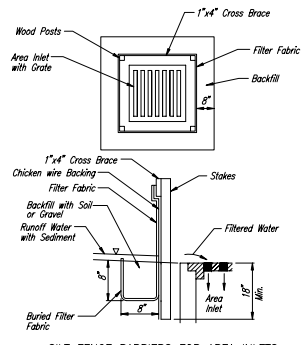
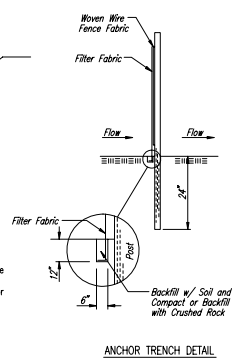

SILT FENCE BARRIERS FOR AREA INLETS (INLET PROTECTION)

Material Specification:
Silt fence fabric should conform to the AASHTO M288 96 silt fence specification. The wire or polymeric mesh backing used to help support the silt fence fabric should conform to the AASHTO M288 96 silt fence specification. The posts used to support the silt fence fabric should be a hardwood material with the following minimum dimensions: 2" square (nominal) by 4' long. The material used to frame the tops of the posts should be 1" by 4" boards. Silt fence fabric and support backing should be attached to the wooden posts and frame with staples, wire, zip ties, or nails.

Placement:
Place a silt fence drop inlet barrier in a location where it is unlikely to be overtopped. Water should flow through silt fence, not over it. Silt fence barriers for area inlets often fail when repeatedly overtopped. When used as a barrier for area inlets, silt fence fabric and posts must be supported at the top by a wooden frame. When a silt fence barrier for area inlets is located near an inlet that has steep approach slopes, the storage capacity behind the barrier is drastically reduced. Timely removal of sediment must occur for a barrier to operate properly in this location.

Proper installation method:
Excavate a trench around the perimeter of the area inlet that is at least 8" deep by 8" wide. Drive posts to a depth of at least 18" around the perimeter of the area inlet. The distance between posts should be 4' or less. If the distance between two adjacent corner posts is more than 4', add another post(s) between them. Connect the tops of all the posts with a wooden frame made of 1" by 4" boards. Use nails or screws for fastening. Attach the wire or polymeric-mesh backing to the outside of the post/frame structure with staples, wire, zip ties, or nails. Roll out a continuous length of silt fence fabric long enough to wrap around the perimeter of the area inlet. Add more length for overlapping the fabric joint. Place the edge of the fabric in the trench, starting at the outside edge of the trench. Line all three sides of the trench with the fabric. Backfill over the fabric in the trench with the excavated soil and compact. After filling the trench, approximately 24" to 36" of silt fence fabric should remain exposed. Attach the silt fence to the outside of the post/frame structure with staples, wire, zip ties, or nails. The joint should be overtopped to the next post.

Note: When a silt fence barrier for area inlet is placed in a shallow median ditch, make sure that the top of the barrier is not higher than the paved road. In this configuration, water may spread onto the roadway causing a hazardous condition.

List of common placement/installation mistakes to avoid:
Water should flow through a silt fence barrier for area inlet—not over it. Place a silt fence barrier for area inlet in a location where it is unlikely to be overtopped. Silt fence barrier for area inlets often fail when repeatedly overtopped. Do not place posts on the outside of the silt fence barrier for area inlet. In this configuration, the force of the water is not resisted by the posts, but only by the staples (wire, zip ties, nails, etc.). The silt fence will rip and fail. Do not install silt fence barrier for area inlets without framing the top of the posts. The corner posts around area inlets are stressed in two directions whereas a normal silt fence is only stressed in one direction. This added stress requires more support.

Inspection and Maintenance:
Silt fence barrier for area inlets should be inspected every 7 days and within 24 hours of a rainfall of 1/2" or more. The following is a list of questions that should be addressed during each inspection:
Does water flow under the silt fence?
Does the silt fence sag excessively?
Has the silt fence torn or become detached from the posts?
Does sediment need to be removed from behind the area inlet barrier?

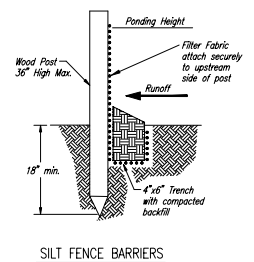

SILT FENCE BARRIERS

Material Specification:
Silt fence fabric should conform to the AASHTO M288 96 silt fence specification. The posts used to support the silt fence fabric should be a hardwood material with the following minimum dimensions: 2" square (nominal) by 4' long. Silt fence fabric should be attached to the wooden posts with staples, wire, zip ties, or nails.

Placement:
A slope barrier should be used at the toe of a slope when a ditch does not exist. The slope barrier should be placed on nearly level ground 5' to 10' away from the toe of a slope. The barrier is placed away from the toe of the slope to provide adequate storage for settling out sediment. When practicable, silt fence slope barriers should be placed along contours to avoid a concentration of flow. Silt fence slope barriers can also be placed along right-of-way fence lines to keep sediment from crossing into adjacent property. When placed in this manner, the slope barrier will not likely follow contours.

Proper installation method:
Excavate a trench the length of the planned slope barrier that is 6" deep by 4" wide. Make sure that the trench is excavated along a single contour. When practicable, slope barriers should be placed along contours to avoid a concentration of flow. Place the soil on the upslope side of the trench for later use. Roll out a continuous length of silt fence fabric on the downslope side of the trench. Place the edge of the fabric in the trench starting at the top upslope edge. Line all three sides of the trench with the fabric. Backfill over the fabric in the trench with the excavated soil and compact. After filling the trench, approximately 24" to 36" of silt-fence fabric should remain exposed. Lay the exposed silt fence upslope of the trench to clear an area for driving in the posts. Just downslope of the trench, drive posts into the ground to a depth of at least 18". Place posts no more than 4' apart. Attach the silt fence to the anchored post with staples, wire, zip ties, or nails.

List of common placement/installation mistakes to avoid:
When practicable, do not place silt fence slope barriers across contours. Slope barriers should be placed along contours to avoid a concentration of flow. When the flow concentrates, it overtops the barrier and the silt fence slope barrier quickly deteriorates. Do not place silt-fence posts on the upslope side of the silt fence fabric. In this configuration, the force of the water is not restricted by the posts, but only by the staples (wire, zip ties, nails, etc.). The silt fence will rip and fail. Do not place silt fence slope barriers in areas with shallow soils underlain by rock. If the barrier is not sufficiently anchored, it will wash out. Silt fence slope barriers must be dug into the ground—silt fence at ground level does not work because water will flow underneath.

Inspection and Maintenance:
Silt fence slope barriers should be inspected every 7 days and within 24 hours of a rainfall of 1/2" or more. The following is a list of questions that should be addressed during each inspection:
Are there any points along the slope barrier where water is concentrating?
Does water flow under the slope barrier?
Do the silt fences sag excessively?
Has the silt fence torn or become detached from the posts?
Does sediment need to be removed from behind the slope barrier?

	SILT FENCE BARRIERS SILT FENCE DITCH CHECK AND BARRIER DETAILS	
	JIM ARMOUR, P.E. CITY ENGINEER	
	PROJECT NUMBER	DCA NO.
	DATE JAN. 2007	SHEET _ OF _

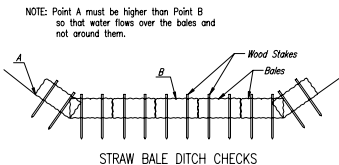

NOTE: Point A must be higher than Point B so that water flows over the bales and not around them.

Material Specification:
 Bale ditch checks may be constructed of wheat straw, oat straw, prairie hay, or bromegrass hay that is free of weeds declared noxious by the Kansas State Board of Agriculture. The stakes used to anchor the bales should be a hardwood material with the following minimum dimensions: 2" square (nominal) by 4' long.
 Optional: The downstream scour apron should be constructed of a double-netted straw erosion-control blanket at least 6' wide.
 Optional: The metal landscape staples used to anchor the erosion-control blanket should be at least 6" long.

Placement:
 Bale ditch checks should be placed perpendicular to the flowline of the ditch. The ditch check should extend far enough so that the ground level at the ends of the check is higher than the top of the lowest center bale. This prevents water from flowing around the check.
 Straw bale ditch checks should not be placed in ditches where high flows are expected. Rock checks should be used instead.
 Bales should be placed in ditches with slopes of 6% or less. For slopes steeper than 6%, rock checks should be used.
 The following table provides check spacing for a given ditch grade:

Ditch grade (%)	Check Spacing (feet)
0.5	200
1.0	200
2.0	100
3.0	65
4.0	50
5.0	40
6.0	30

Proper installation method:
 Excavate a trench perpendicular to the ditch flowline that is 4" deep and a bale's width wide. Extend the trench in a straight line along the entire length of the proposed ditch check. Place the soil on the upstream side of the trench-it will be used later.
 Optional: On the downstream side of the trench, roll out a length of erosion-control blanket (scour apron) equal to the length of the trench. Place the upstream edge of the erosion-control blanket along the bottom upstream edge of the trench. The erosion control blanket should be anchored in the trench with one row of 6" landscape staples placed on 16" centers. The remainder of the erosion-control blanket (the portion that is not lying in the trench) will serve as the downstream scour apron. This section of the blanket should be anchored to the ground with 6" landscape staples placed around the perimeter of the blanket on 16" centers. The remainder of the blanket should be anchored using two evenly spaced rows of 6" landscape staples on 16" centers placed perpendicular to the flowline of the ditch.
 Place the bales in the trench, making sure that they are butted tightly. Two stakes should be driven through each bale along the centerline of the ditch check, approximately 6" to 8" in from the bale ends. Stakes should be driven at least 12" into the ground.
 Once all the bales have been installed and anchored, place the excavated soil against the upstream side of the check and compact it. The compacted soil should be no more than 3" to 4" deep and extend upstream no more than 24".

List of common placement/installation mistakes to avoid:
 Do not place a bale ditch check directly in front of a culvert outlet. It will not stand up to the concentrated flow.
 Do not place bale ditch checks in ditches that will likely experience high flows. They will not stand up to concentrated flow.
 Follow prescribed ditch-check spacing guidelines. If spacing guidelines are exceeded, erosion will occur between the ditch checks.
 Do not allow water to flow around the ditch check. Make sure that the ditch check is long enough so that the ground level at the ends of the check is higher than the top of the lowest center bale.
 Do not place bale ditch checks in channels with shallow soils underlain by rock. If the check is not anchored sufficiently, it will wash out.
 Bale ditch checks must be dug into the ground. Bales at ground level do not work because they allow water to flow under the check.

Inspection and Maintenance:
 Bale ditch checks should be inspected every 7 days and within 24 hours of a rainfall of 1/2" or more. The following is a list of questions that should be addressed during each inspection:
 Does water flow around the ditch check?
 Does water flow under the ditch check?
 Does water flow through spaces between abutting bales?
 Are any bales and/or scour aprons (optional) dislodged?
 Are bales decomposing due to age and/or water damage?
 Does sediment need to be removed from behind the ditch check?

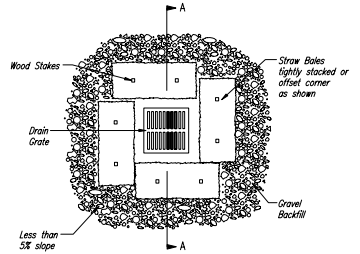
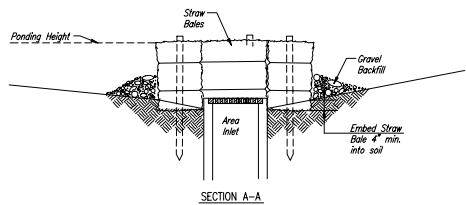

STRAW BALE BARRIERS FOR AREA INLETS (INLET PROTECTION)

Material Specification:
 Bale area inlet barriers should be constructed of wheat straw, oat straw, prairie hay, or bromegrass hay that is free of weeds declared noxious by the Kansas State Board of Agriculture.
 The stakes used to anchor the bales should be a hardwood material with the following minimum dimensions: 2" square (nominal) by 4' long.
 Twine should be used to bind bales. The use of wire binding is prohibited because it does not biodegrade readily.

Placement:
 Bale area inlet barriers should be placed directly around the perimeter of a drop inlet. When a bale area inlet barrier is located near an inlet that has steep approach slopes, the storage capacity behind the barrier is drastically reduced. Timely removal of sediment must occur for a barrier to operate properly in this location.

Proper Installation Method:
 Excavate a trench around the perimeter of the area inlet that is at least 4" deep by a bale's width wide.
 Place the bales in the trench, making sure that they are butted tightly. Some bales may need to be shortened to fit into the trench around the area inlet. Two stakes should be driven through each bale, approximately 6" to 8" in from the bale ends.
 Stakes should be driven at least 12" into the ground.
 Once all the bales have been installed and anchored, place the excavated soil against the receiving side of the barrier and compact it. The compacted soil should be no more than 3" to 4" deep.
 Note: When a bale area inlet barrier is placed in a shallow median ditch, make sure that the top of the barrier is not higher than the paved road. In this configuration, water may spread onto the roadway causing a hazardous condition.

List of common placement installation mistakes to avoid:
 Bales should be placed directly against the perimeter of the area inlet. This allows overtopping water to flow directly into the inlet instead of onto nearby soil causing scour.
 Bale area inlet barriers must be dug into the ground. Bales at ground level do not work because they allow water to flow under the barrier.

Inspection and Maintenance:
 Bale area inlet barriers should be inspected every 7 days and within 24 hours of a rainfall of 1/2" or more. The following is a list of questions that should be addressed during each inspection:
 Does water flow under the area inlet barrier?
 Does water flow through spaces between abutting bales?
 Are any bales dislodged?
 Are bales decomposing due to age and/or water damage?
 Does sediment need to be removed from behind the area inlet barrier?

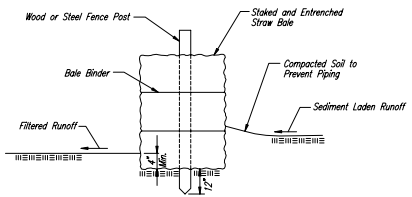

STRAW BALE BARRIERS

Material Specification:
 Bale slope barriers may be constructed of wheat straw, oat straw, prairie hay, or bromegrass hay that is free of weeds declared noxious by the Kansas State Board of Agriculture. The stakes used to anchor the bales should be a hardwood material with the following minimum dimensions: 2" square (nominal) by 4' long.
 Twine should be used to bind bales. The use of wire binding is prohibited because it does not biodegrade readily.

Placement:
 A slope barrier should be used at the toe of a slope when a ditch does not exist. The slope barrier should be placed on a nearly level ground 5' to 10' away from the toe of a slope. The barrier is placed away from the toe of the slope to provide adequate storage for setting out sediment.
 When practicable, bale slope barriers should be placed along contours to avoid a concentration of flow.
 Bale slope barriers can also be placed along right-of-way fence lines to keep sediment from crossing onto adjacent property. When placed in this manner, the slope barrier will not likely follow contours.

Proper installation method:
 Excavate a trench the length of the planned slope barrier that is 4" deep and a bale's width wide. Make sure that the trench is excavated along a single contour. When practicable, slope barriers should be placed along contours to avoid a concentration of flow. Place the soil on the upslope side of the trench for later use.
 Place the bales in the trench, making sure that they are butted tightly. Two stakes should be driven through each bale along the centerline of the ditch check, approximately 6" to 8" in from the bale ends. Stakes should be driven at least 12" into the ground.
 Once all the bales have been installed and anchored, place the excavated soil against the upslope side of the check and compact it. The compacted soil should be no more than 3" to 4" deep.

List of common placement/installation mistakes to avoid:
 When practical, do not place bale slope barriers across contours. Slope barriers should be placed along contours to avoid a concentration of flow. Concentrated flow over a slope barrier creates a scour hole on the downslope side of the barrier. The scour hole eventually undermines the bales and the barrier fails.
 Do not place bale slope barriers in areas with shallow soils underlain by rock. If the barrier is not anchored sufficiently, it will wash out.
 Bale slope barriers must be dug into the ground. Bales at ground level do not work because they allow water to flow under the barrier.

Inspection and Maintenance:
 Bale slope barriers should be inspected every 7 days and within 24 hours of a rainfall of 1/2" or more. The following is a list of questions that should be addressed during each inspection:
 Are there any points along the slope barrier where water is concentrating?
 Does water flow under the slope barrier?
 Does water flow through spaces between abutting bales?
 Are any bales dislodged?
 Are bales decomposing due to age and/or water damage?
 Does sediment need to be removed from behind the slope barrier?

	SOIL EROSION BMPs STRAW BALE DITCH CHECK AND BARRIER DETAILS	
	JIM ARMOUR, P.E. CITY ENGINEER	
	PROJECT NUMBER	DCA NO.
	DATE JAN. 2007	SHEET <u> </u> OF <u> </u>

GENERAL NOTES:

1. THIS SHEET IS INTENDED TO PROVIDE GUIDELINES AS TO WHAT TYPES OF EROSION CONTROL DEVICES WILL BE INSTALLED DURING THE CONSTRUCTION PROCESS. CONTRACTORS ARE EXPECTED TO BID PROJECTS ACCORDINGLY.
2. EROSION CONTROL DEVICES MUST BE MAINTAINED BY THE CONTRACTOR THROUGHOUT THE CONSTRUCTION PROCESS AND UNTIL THE DISTURBED EARTH IS RESTABILIZED.
3. IF THE PROJECT WILL DISTURB 1 ACRE OR MORE, A FEDERAL/STATE NPDES STORMWATER PERMIT IS REQUIRED. A DETAILED STORMWATER POLLUTION PREVENTION PLAN IS REQUIRED. THE EROSION CONTROL DEVICES SHOWN ON THIS SHEET ARE CONSIDERED TO BE THE MINIMUM TO BE SHOWN IN THE POLLUTION PREVENTION PLAN.
4. FOR PROJECTS DISTURBING LESS THAN 1 ACRE, CONTRACTORS ARE ENCOURAGED TO PREPARE STORMWATER POLLUTION PREVENTION PLANS PRIOR TO CONSTRUCTION. EROSION CONTROL DEVICES MUST BE USED ON ALL PROJECTS.
5. FAILURE TO USE AND MAINTAIN EROSION CONTROL DEVICES IS A VIOLATION OF SECTION 16.32 OF THE CITY CODE AND WILL SUBJECT THE CONTRACTOR TO THE PENALTIES PROVIDED FOR THEREIN.
6. THE APPLICATION OF EROSION CONTROL DEVICES SHOWN ON THIS SHEET IS FOR SITUATIONS NORMALLY ENCOUNTERED. FROM TIME TO TIME, SITUATIONS WILL ARISE THAT MAY REQUIRE A DIFFERENT DEVICE OTHER THAN THOSE SHOWN. EROSION CONTROL DEVICES, OTHER THAN THOSE SHOWN, MAY BE UTILIZED AS LONG AS THEY ARE EFFECTIVE AND MAINTAINED.

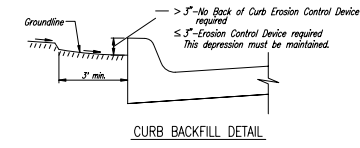
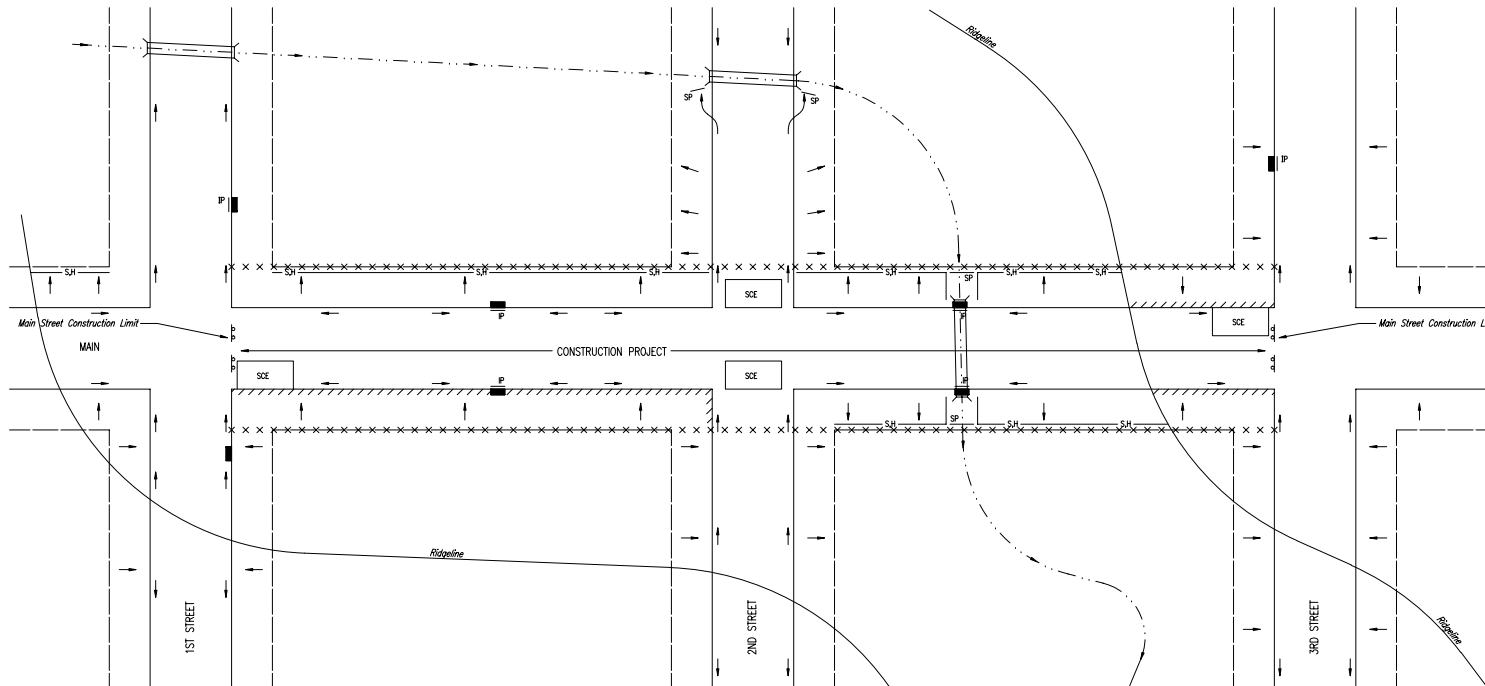

NOTES:

1. THE INTENT OF ALL EROSION CONTROL DEVICES IS TO KEEP ALL SEDIMENT CONFINED TO THE CONSTRUCTION SITE, AND OUT OF ALL UNDERGROUND PIPES, DITCHES, LAKES, AND OTHER DRAINAGE FACILITIES, AND OFF OF STREETS.
2. THE POINT OF COMPLIANCE IS GENERALLY THE RIGHT-OF-WAY LINES WITHIN THE LIMITS OF CONSTRUCTION.
3. EROSION CONTROL DEVICES WILL BE REQUIRED AT ALL POINTS ALONG THE PROJECT WHERE DISTURBED EARTH CAN DRAIN ONTO PRIVATE PROPERTY.
4. INLET PROTECTION DEVICES WILL BE REQUIRED WHEREVER WATER CAN DRAIN OFF THE PROJECT SITE INTO AN INLET, INCLUDING ANY SIDE STREET INLETS.
5. EROSION CONTROL DEVICES SHALL BE INSTALLED AT CREEK CROSSINGS SO AS TO PREVENT SEDIMENT FROM ENTERING THEREIN.
6. STABILIZED CONSTRUCTION ENTRANCES SHALL BE PROVIDED, AS NEEDED, TO PREVENT MUD FROM TRACKING ONTO STREETS NOT UNDER CONSTRUCTION AND ON STREETS WITHIN THE PROJECT LIMITS IF TRAFFIC IS BEING MAINTAINED THROUGH THE PROJECT.
7. ANY MUD TRACKED ONTO STREETS MUST BE REMOVED AT THE END OF EACH WORK DAY.
8. THE CONTRACTOR WILL BE REQUIRED TO PLACE EROSION CONTROL DEVICES BACK OF CURB, WHENEVER WATER CAN DRAIN OVER CURBS, TO KEEP ERODED SOIL OUT OF THE GUTTERLINES, IN ACCORDANCE WITH THE FOLLOWING:
 - A. THE DEVICE REQUIRED WILL BE CURLEX I OR II EXCELSIOR BLANKET, OR EQUAL. SAID BLANKET SHALL BE PLACED OVER THE APPROPRIATE SEED AND FERTILIZER, AS SPECIFIED IN THE PROJECT SPECIFICATIONS. (SEE SOIL EROSION BMPs - BACK OF CURB SEDIMENT BARRIER DETAILS)
 - B. THIS DEVICE SHALL BE INSTALLED IMMEDIATELY WHENEVER THE CURB IS BACKFILLED TO WITHIN 3" OF THE TOP OF CURB. (SEE CURB BACKFILL DETAIL)
 - C. ADDITIONALLY, OTHER EROSION CONTROL DEVICES (HAY BALES, SILT FENCE, ETC.) WILL BE INSTALLED AT LOCATIONS WHERE CONCENTRATED FLOW CARRIES SEDIMENT OVER THE CURB.
 - D. SHOULD THE PROJECT PLANS SPECIFY THAT THE RIGHT-OF-WAY IS TO BE SODDED, THE EXCELSIOR MAT WILL NOT BE REQUIRED SO LONG AS THE SOD IS PLACED WITHIN 48 HOURS AFTER CURB BACKFILL REACHES A HEIGHT OF 3" OR LESS FROM TOP OF CURB. (SEE CURB BACKFILL DETAIL)

LEGEND

--- R-O-W LIMITS
→ DRAINAGE FLOW PATH
x x x x x R/W LIMIT WITHIN CONSTRUCTION LIMIT
SWI STORM WATER INLETS
IP INLET PROTECTION
SP STREAM PROTECTION
SCE STABILIZED CONSTRUCTION ENTRANCE
BCP BACK OF CURB PROTECTION

	SOIL EROSION BMPs
	STREET IMPROVEMENT PROJECTS
	JIM ARMOUR, P.E. CITY ENGINEER
	PROJECT NUMBER: _____ OCA NO.: _____
DATE: JAN. 2007	SHEET ___ OF ___

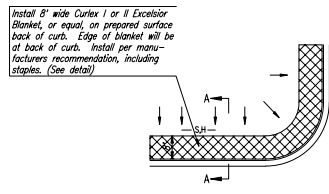
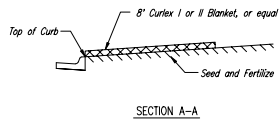
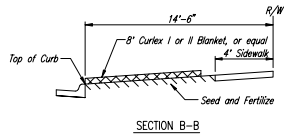

SOUTH STREET

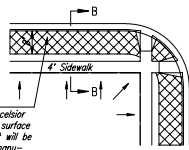

Install 8" wide Curlex I or II Excelsior Blanket, or equal, on prepared surface back of curb. Edge of blanket will be at back of curb. Install per manufacturer's recommendation, including staples. (See detail).

- NOTES:
- EXCELSIOR MAT TO BE INSTALLED WHEN SOD IS NOT SPECIFIED ON PROJECT.
 - EXCELSIOR BLANKET TO BE INSTALLED OVER SEED AND FERTILIZER, AS SPECIFIED IN THE PROJECT SPECIFICATIONS.
 - AFTER INSTALLATION OF EXCELSIOR BLANKET, AT LOCATIONS WHERE CONCENTRATED FLOW CARRIES SEDIMENT OVER THE CURB AND INTO THE GUTTER, SUPPLEMENTAL EROSION CONTROL DEVICES WILL BE INSTALLED BY THE CONTRACTOR AS NEEDED, TO FIX THE PROBLEM.

BACK OF CURB PROTECTION DETAIL

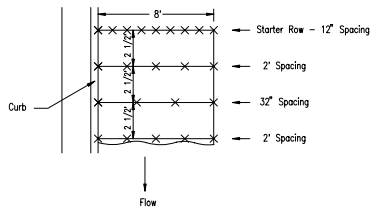

NOTES: Use 6" seam overlap

DETAILS FOR CURLEX I OR II BLANKETS

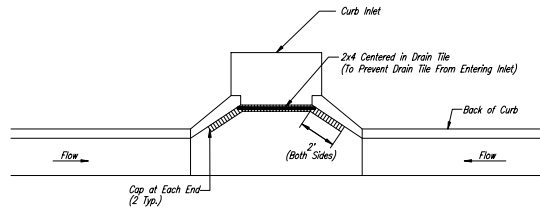

Note: Place 4" perforated PVC pipe, filled with 1/2"-1" dia. gravel, in front of curb inlet as shown.

2x4 LENGTH	INLET TYPE	INLET OPENING
5'-6"	1-A	5'-0"
10'-6"	1-A	10'-0"
15'-6"	1-A	15'-0"

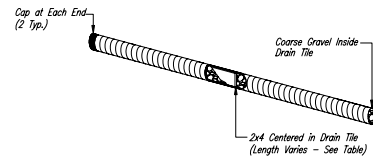

CURB INLET PROTECTION
4" PERFORATED PIPE W/ GRAVEL

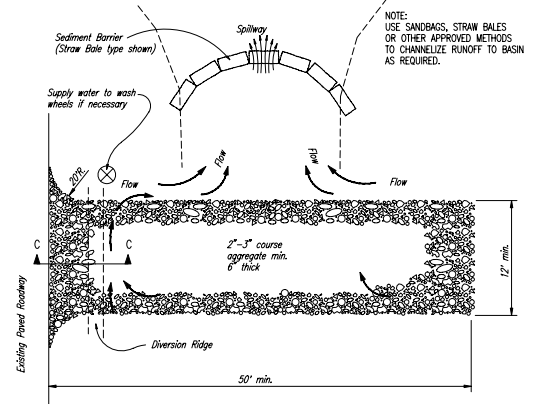
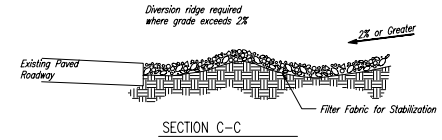

STABILIZED CONSTRUCTION ENTRANCE

NOTES:

- THE ENTRANCE SHALL BE MAINTAINED IN A CONDITION THAT WILL PREVENT TRACKING OR FLOWING OF SEDIMENT ONTO PUBLIC RIGHTS-OF-WAY. THIS MAY REQUIRE TOP DRESSING, REPAIR AND/OR CLEANOUT OF ANY MEASURES USED TO TRAP SEDIMENT.
- WHEN NECESSARY, WHEELS SHALL BE CLEANED PRIOR TO ENTRANCE ONTO PUBLIC RIGHT-OF-WAY.
- WHEN WASHING IS REQUIRED, IT SHALL BE DONE ON AN AREA STABILIZED WITH CRUSHED STONE THAT DRAINS INTO AN APPROVED SEDIMENT TRAP OR SEDIMENT BASIN, AS SHOWN ABOVE.
- DRIVE ENTRANCES ONTO RESIDENTIAL LOTS WILL NOT BE REQUIRED TO HAVE THE SEDIMENT BARRIER SHOWN, BUT WHEEL WASHING MAY BE REQUIRED IF STABILIZED ENTRANCE IS NOT SUFFICIENT TO KEEP MUD FROM BEING TRACKED ONTO ADJACENT STREET. ENTRANCE SHALL EXTEND FROM BACK OF CURB TO DWELLING.

	SOIL EROSION BMP	
	BACK OF CURB PROTECTION, CURB INLET PROTECTION AND CONSTRUCTION ENTRANCES	
	JIM ARMOUR, P.E. CITY ENGINEER	
	PROJECT NUMBER	PCA NO.
DATE	SHEET _ OF _	
JAN. 2007		