

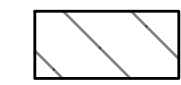



**LEGEND**

-  Phase I
-  Channelizer
-  Type III Barricade
-  Type III Barricade w/ Sign
-  Single Post/Skid Mounted Sign

Note:  
 †Type III Barricades and signs are to only be placed during construction through private drive or side street.

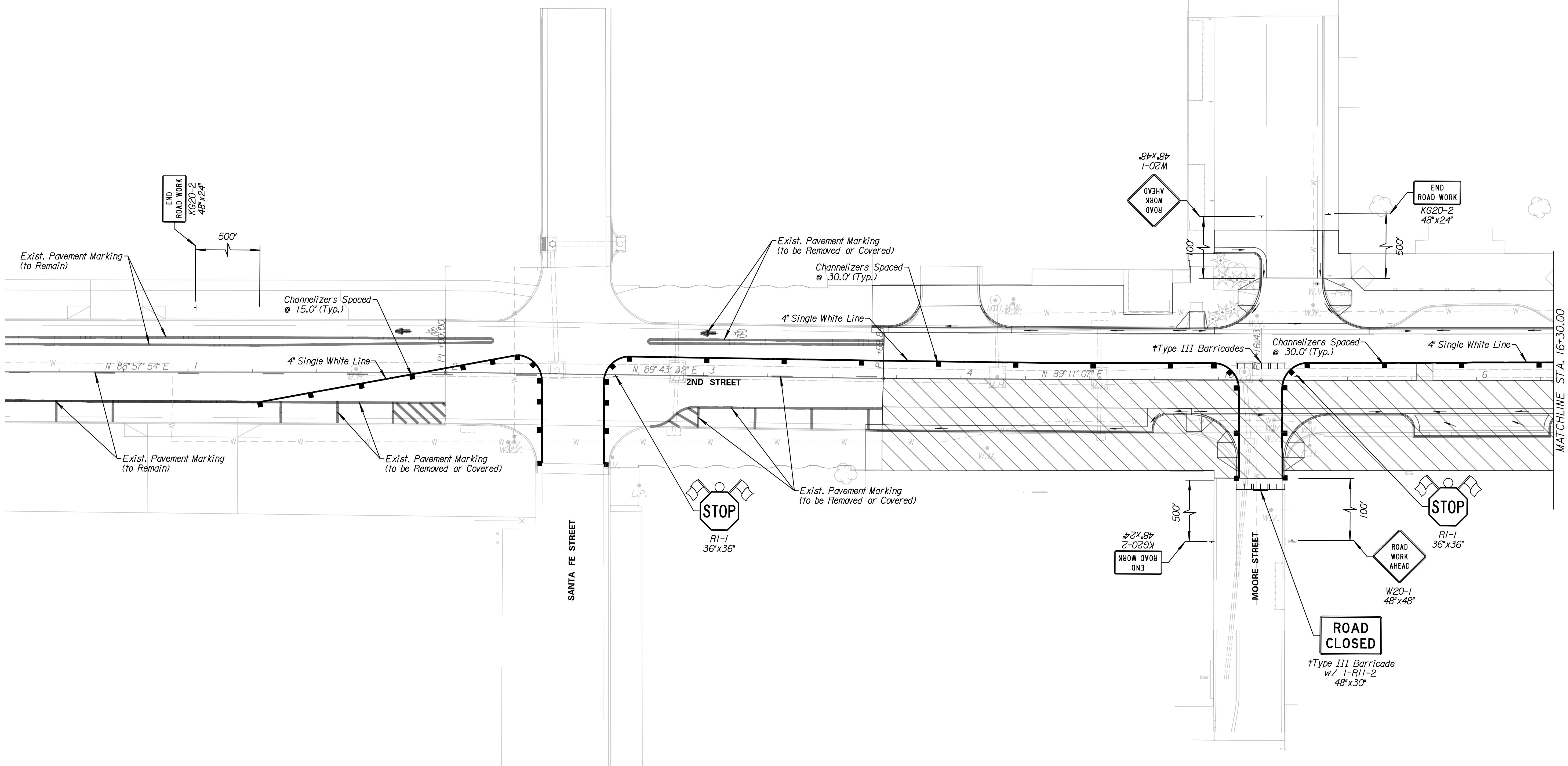
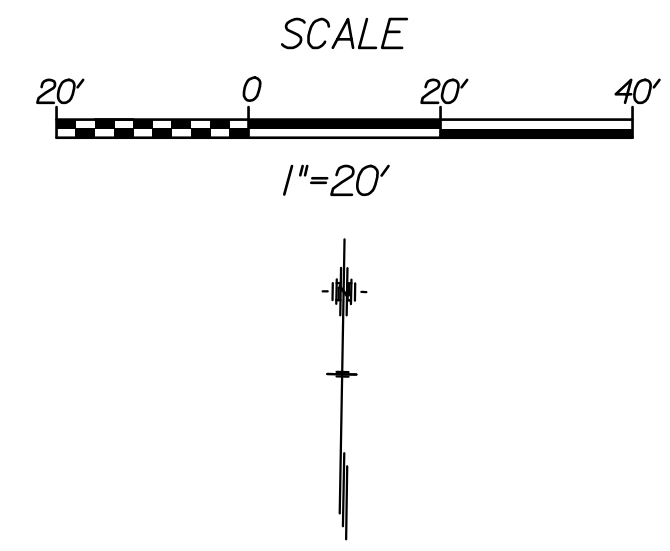

**Tran Systems**  
 245 NORTH WACO  
 SUITE 222  
 WICHITA, KANSAS 67202  
 PHONE: 316-303-3000  
 FAX: 316-303-0166

**CONSULTANTS:**  
  
 LK ARCHITECTURE, INC.  
 345 RIVERVIEW  
 SUITE 200  
 WICHITA, KANSAS 67208  
 PHONE: 316-268-0230

**2ND STREET IMPROVEMENTS  
 SANTA FE TO WASHINGTON IN OLD TOWN**  
 WICHITA, KANSAS  

REVISIONS:	MARK	DATE	DESCRIPTION

PROJ NO: 472-85284  
 SCALE: 1"=20'  
 DATE: 7/11/2018  
 DESIGNED BY: MCG  
 DRAWN BY: MCG  
 CHECKED BY: TAU

**SHEET TITLE:**  
 2ND STREET IMPROVEMENTS  
 TRAFFIC CONTROL  
 PHASE 1

SHEET NO.  
 57  
 SHEET 57 OF 103

7/11/2018 11:45:15 PM - c:\transtransystems\paw\_b\alltransystems\paw\_b\taummed\0494377C-CPP-1M02-101.dgn