





LEGEND

-  Phase 2
-  Channelizer
-  Type III Barricade
-  Type III Barricade w/ Sign
-  Single Post/Skid Mounted Sign

Note:
 †Type III Barricades and signs are to only be placed during construction through private drive or side street.

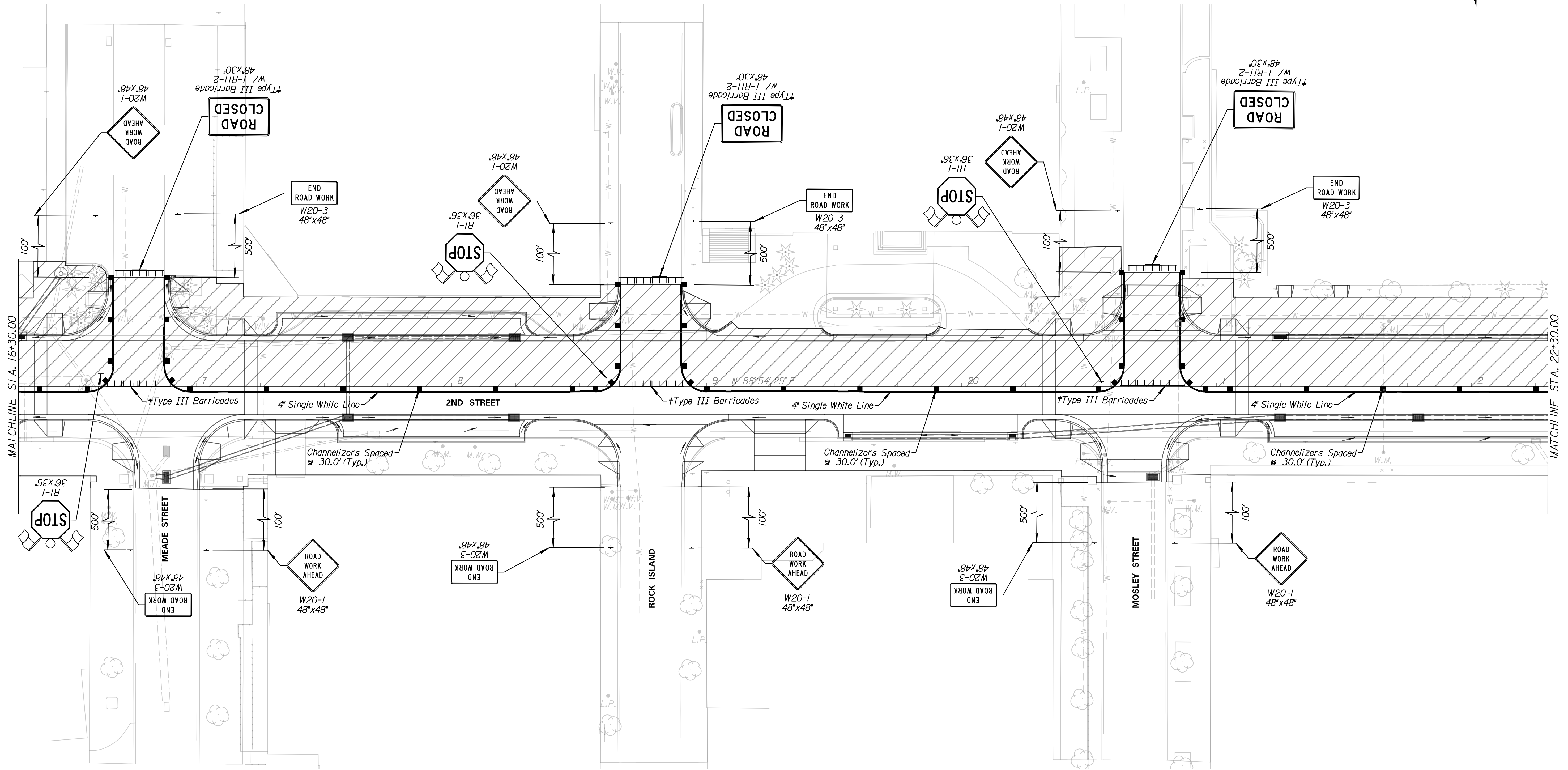
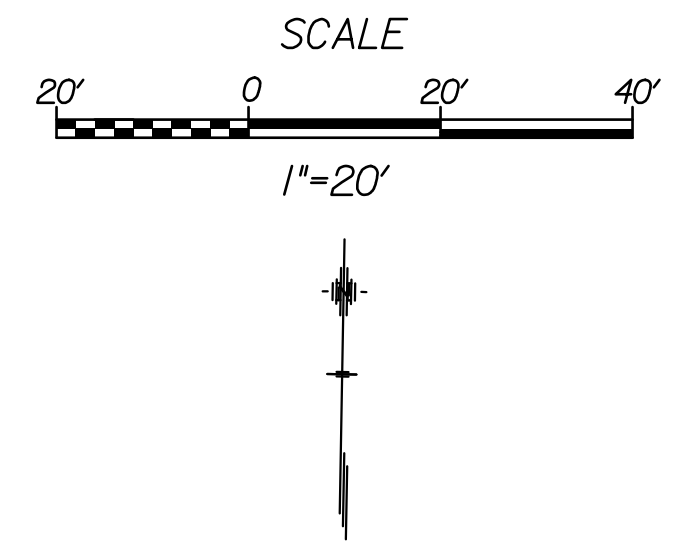

Tran Systems
 245 NORTH WACO
 SUITE 222
 WICHITA, KANSAS 67202
 PHONE: 316-303-3000
 FAX: 316-303-0166

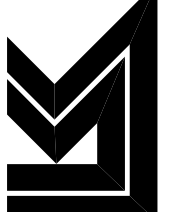
CONSULTANTS:

 LK ARCHITECTURE, INC.
 345 RIVERVIEW
 SUITE 200
 WICHITA, KANSAS 67208
 PHONE: 316-268-0230

2ND STREET IMPROVEMENTS
 SANTA FE TO WASHINGTON IN OLD TOWN
 WICHITA, KANSAS

REVISIONS:	MARK	DATE	DESCRIPTION

PROJ NO: 472-85284
 SCALE: 1"=20'
 DATE: 7/11/2018
 DESIGNED BY: MCG
 DRAWN BY: MCG
 CHECKED BY: TAU

SHEET TITLE:
**2ND STREET IMPROVEMENTS
 TRAFFIC CONTROL
 PHASE 2**

SHEET NO.
62
 SHEET 62 OF 103

tauummel 7/11/2018 11:16:44 PM c:\tran\systems\paw_bocall\transys\paw\taumummel\0494377c-cpp-m02-108.dgn