







LEGEND

-  Phase 2
-  Channelizer
-  Type III Barricade
-  Type III Barricade w/ Sign
-  Single Post/Skid Mounted Sign

Note:  
 †Type III Barricades and signs are to only be placed during construction through private drive or side street.

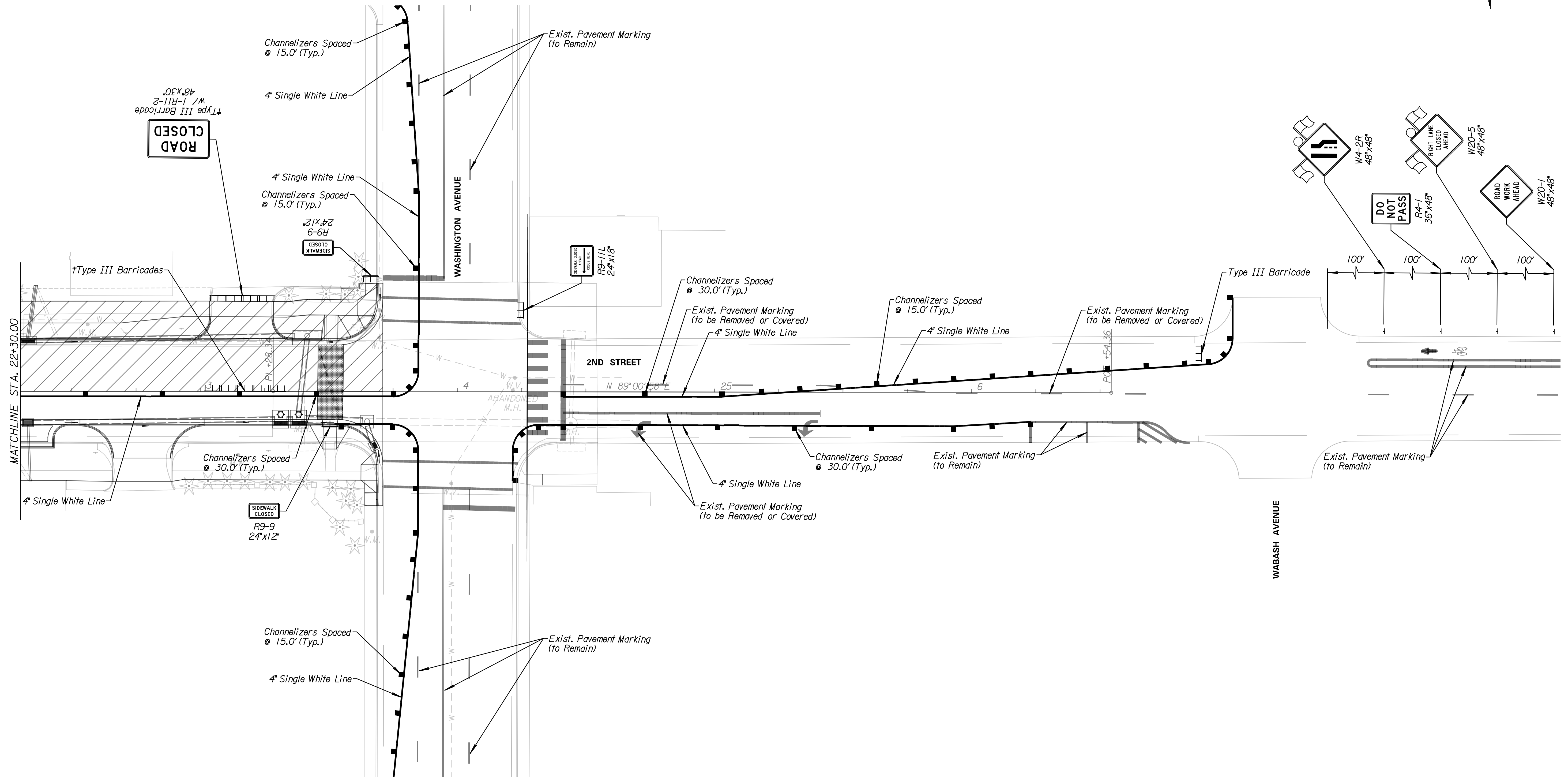
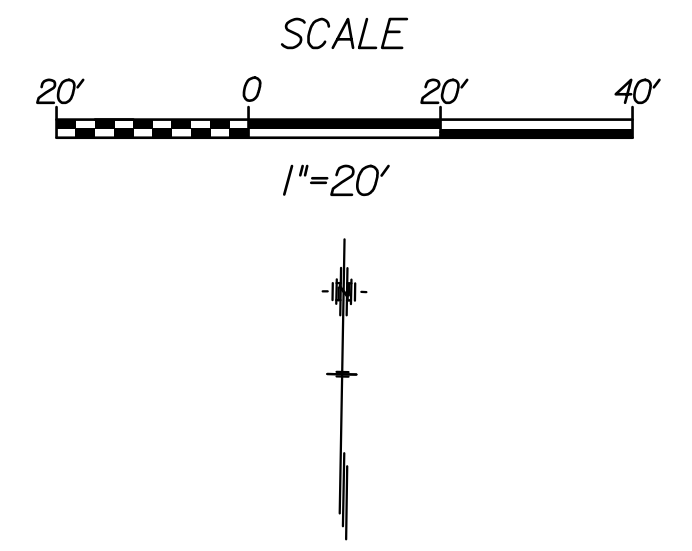

**Tran Systems**  
 245 NORTH WACO  
 SUITE 222  
 WICHITA, KANSAS 67202  
 PHONE: 316-303-3000  
 FAX: 316-303-0166

CONSULTANTS:  
  
 LK ARCHITECTURE, INC.  
 345 RIVERVIEW  
 SUITE 200  
 WICHITA, KANSAS 67208  
 PHONE: 316-268-0230

2ND STREET IMPROVEMENTS  
 SANTA FE TO WASHINGTON IN OLD TOWN  
 WICHITA, KANSAS  

REVISIONS:	MARK	DATE	DESCRIPTION

PROJ NO: 472-85284  
 SCALE: 1"=20'  
 DATE: 7/11/2018  
 DESIGNED BY: MCG  
 DRAWN BY: MCG  
 CHECKED BY: TAU

SHEET TITLE:  
**2ND STREET IMPROVEMENTS  
 TRAFFIC CONTROL  
 PHASE 2**

SHEET NO.  
**63**  
 SHEET 63 OF 103

7/11/2018 11:45:00 PM - c:\transtransystems\paw\_borall\transys\paw\taummettd0484377c-cpp-mm2-107.dgn