

Combined Curb & Gutter (6")

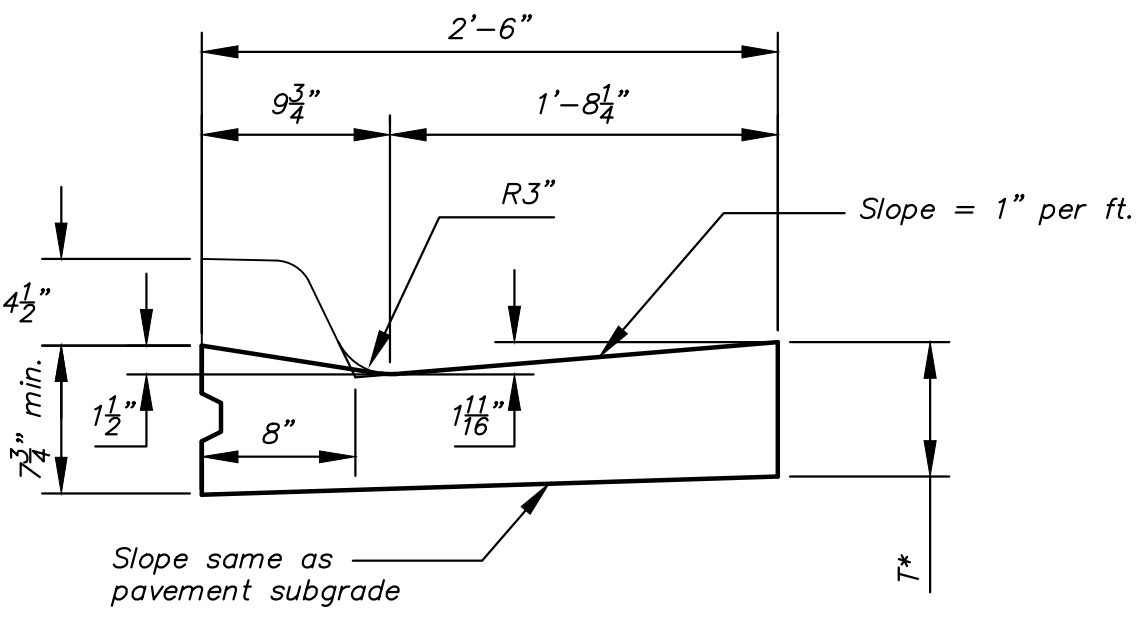

Combined Curb & Gutter (1 1/2")

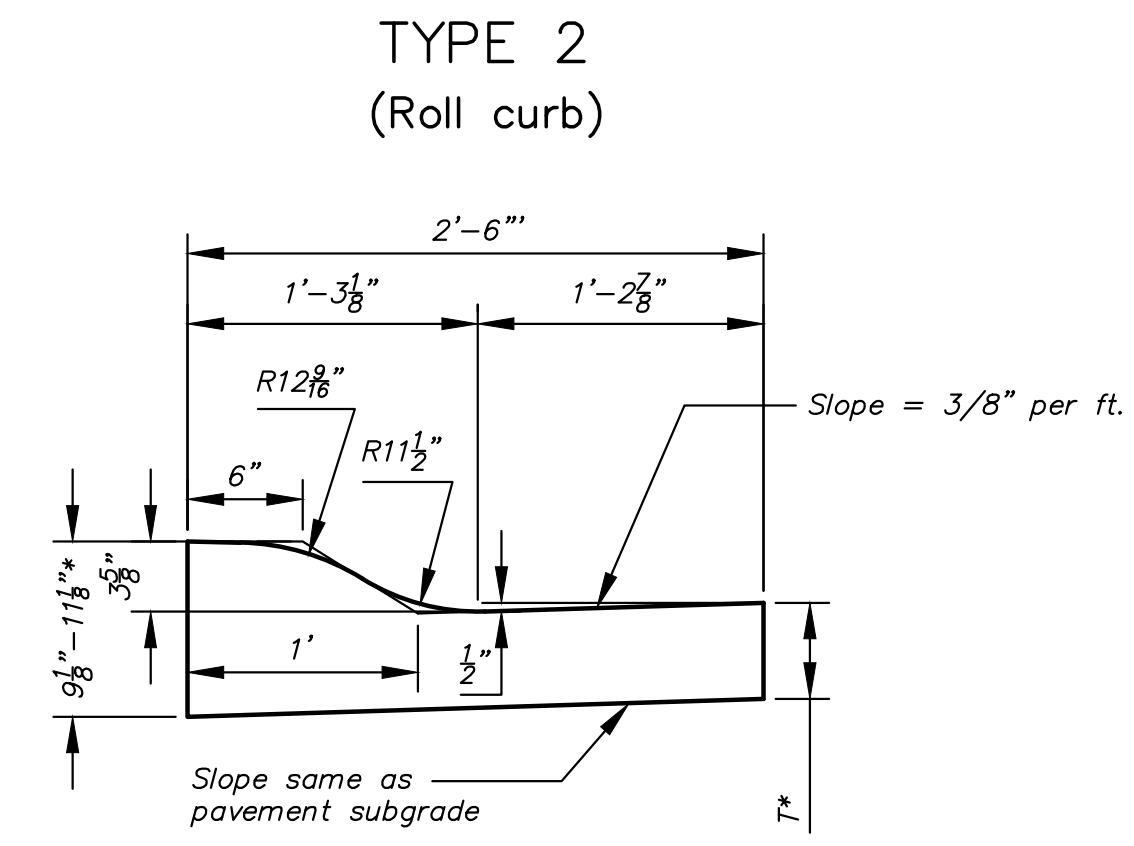

Combined Curb & Gutter (3 5/8")

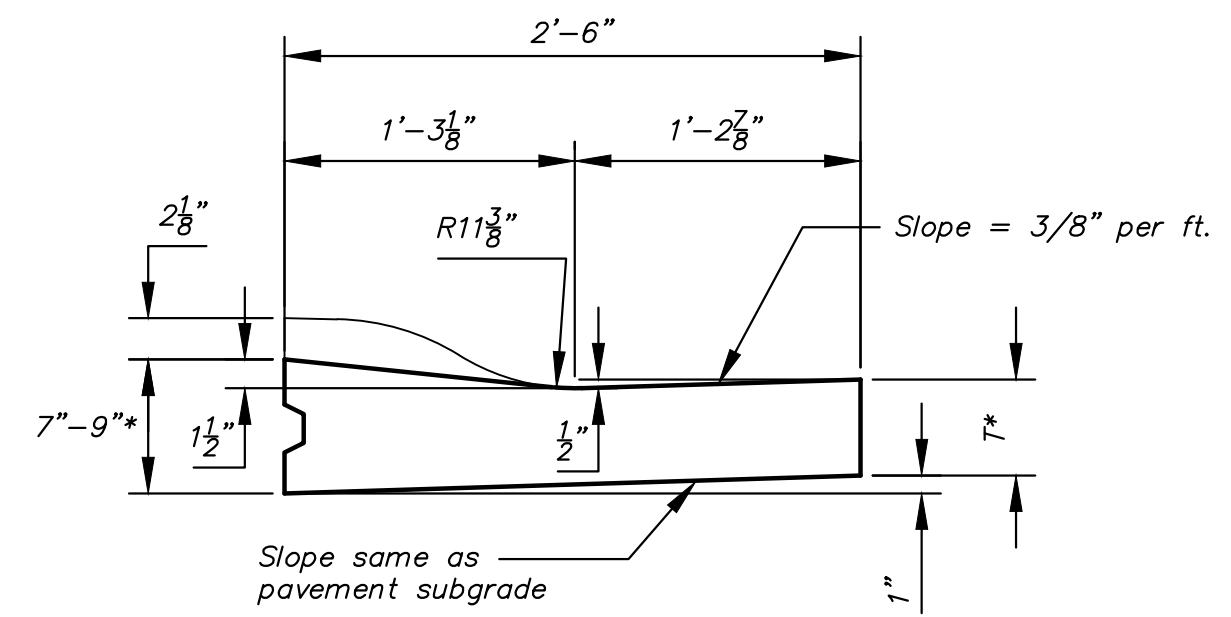

Combined Curb & Gutter (1 1/2")

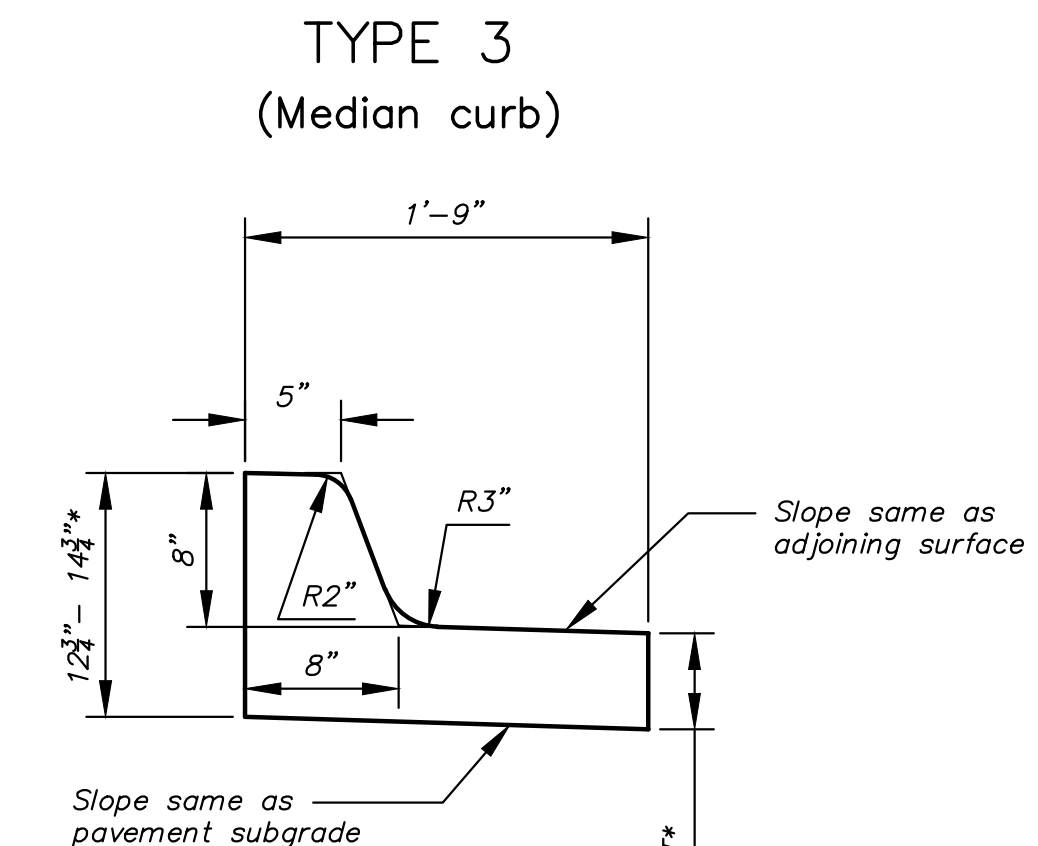

Combined Curb & Gutter (8")

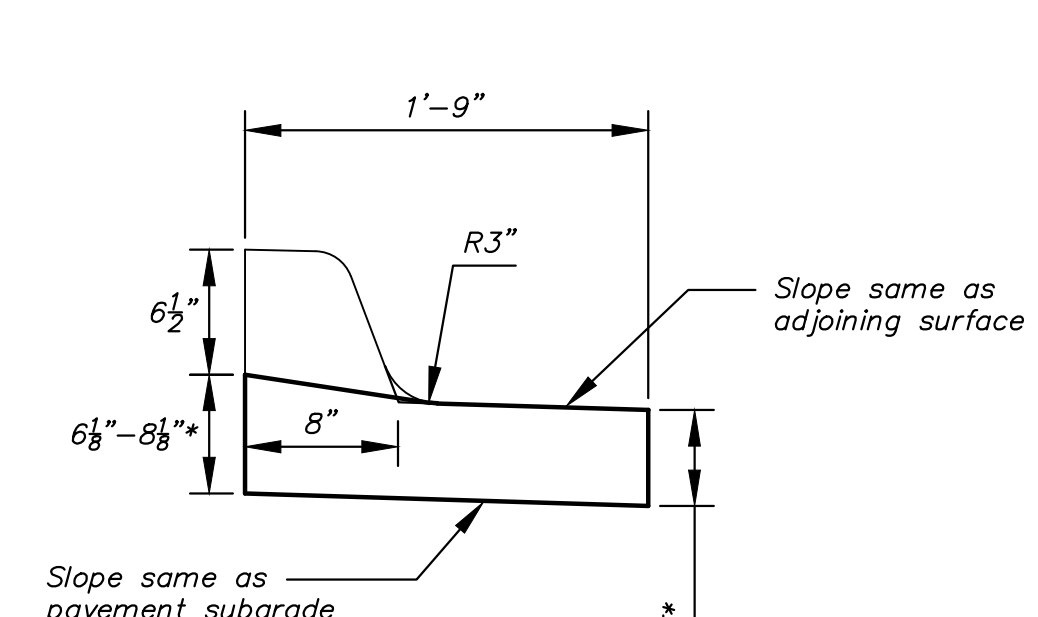

Combined Curb & Gutter (1 1/2")

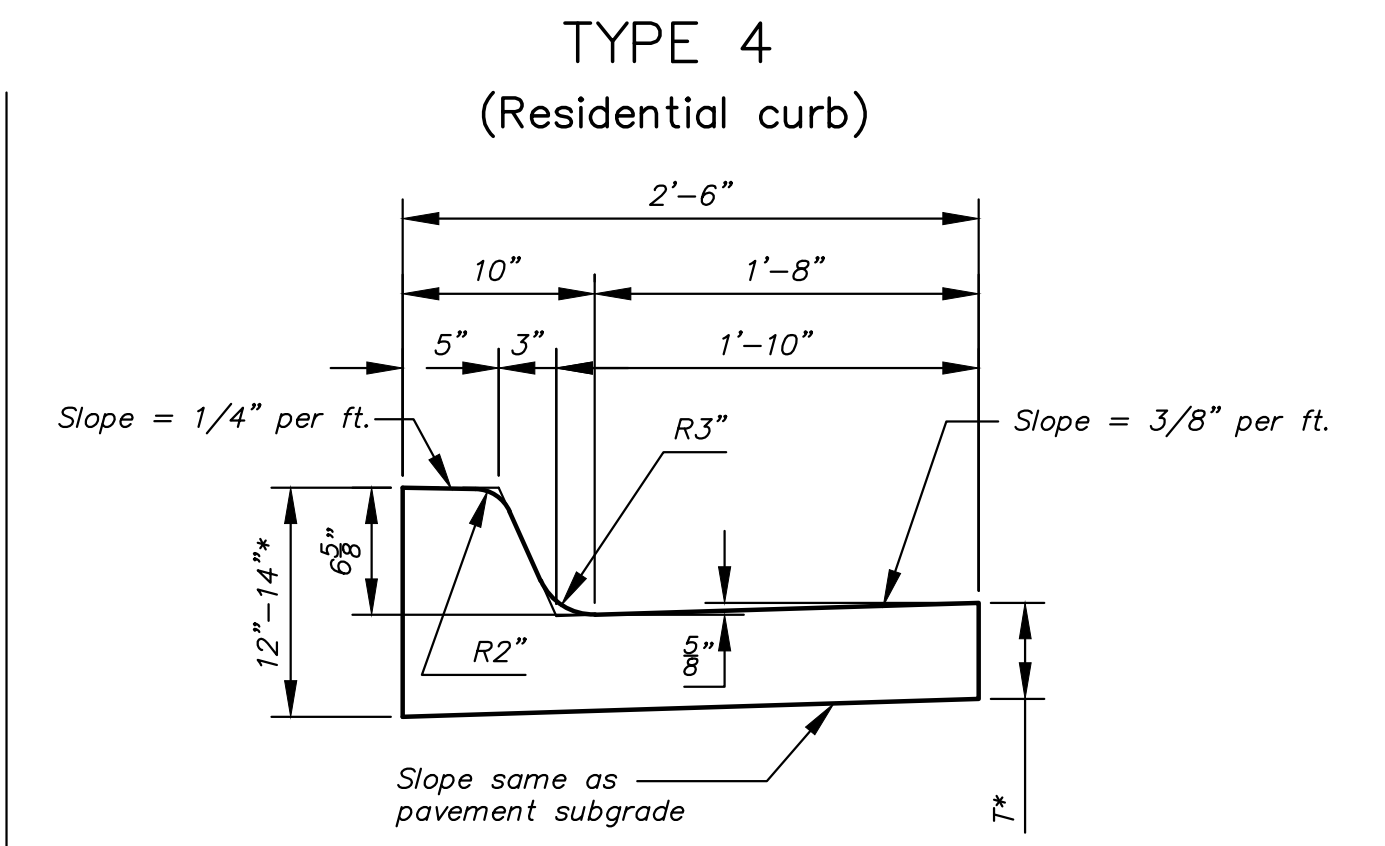

Combined Curb & Gutter (6 5/8")

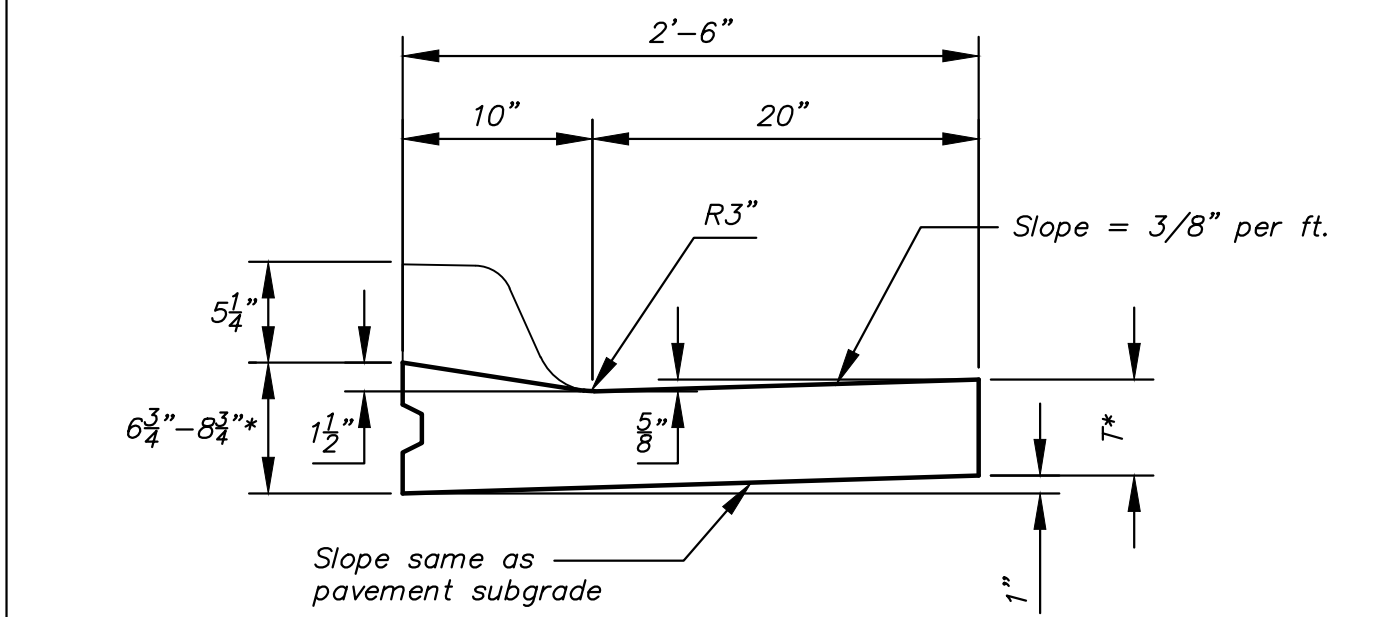

Combined Curb & Gutter (1 1/2")

T* = Thickness of curb to adjust with pavement thickness

GENERAL NOTES

- Expansion (isolation) joints shall be constructed a maximum of 300' apart and at all Pls, PCs, cul-de-sac quadrants, and ends of returns.
- Contraction joints shall be constructed a minimum of 12' apart.
- Joint sealer shall be required at all joints on arterial and industrial streets and at intersections on residential streets.

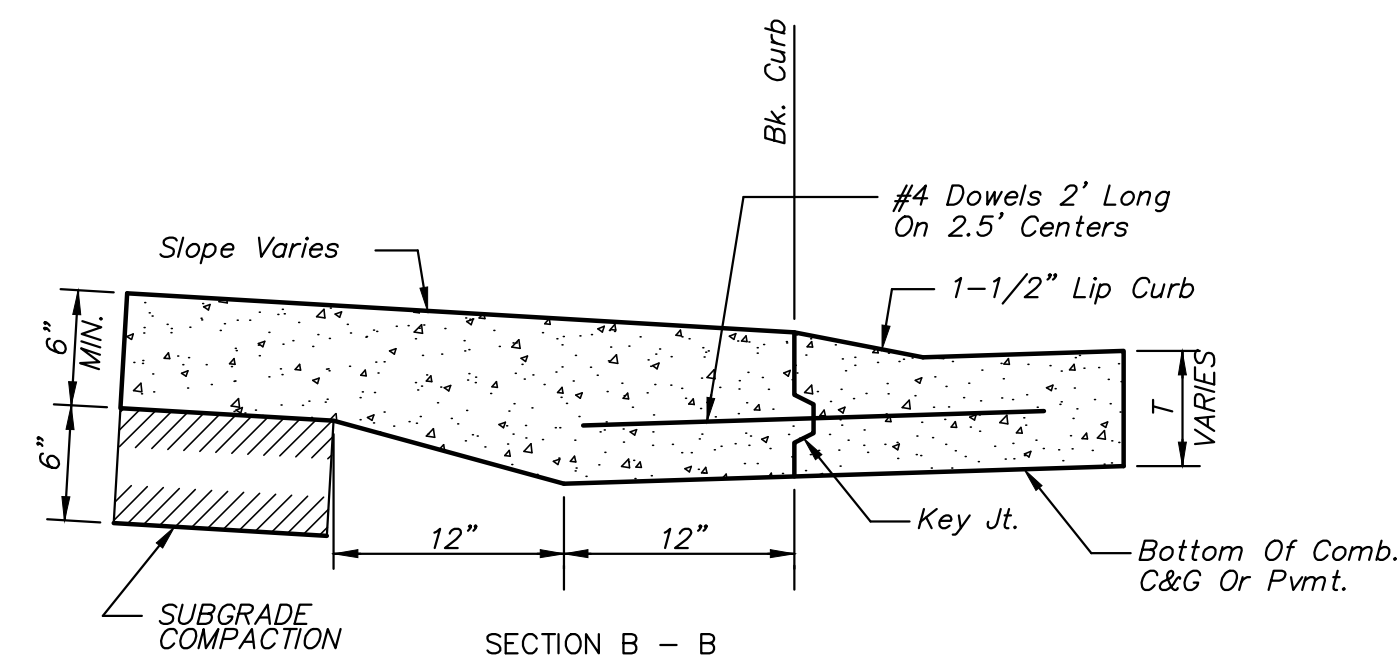

BACK OF CURB DETAIL

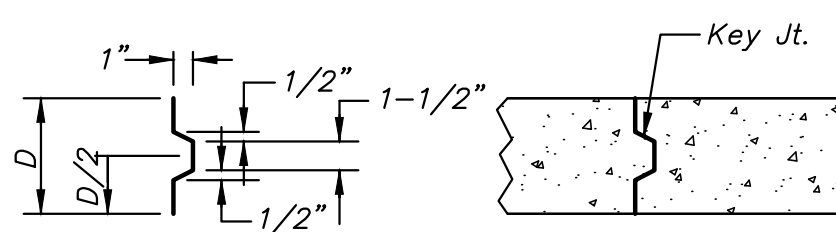

ALT. LONGITUDINAL CONSTRUCTION JOINT

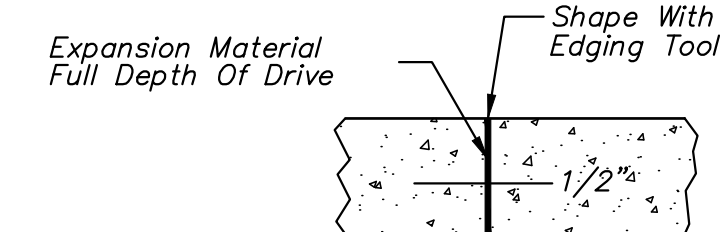

EXPANSION JOINT (E.J.)

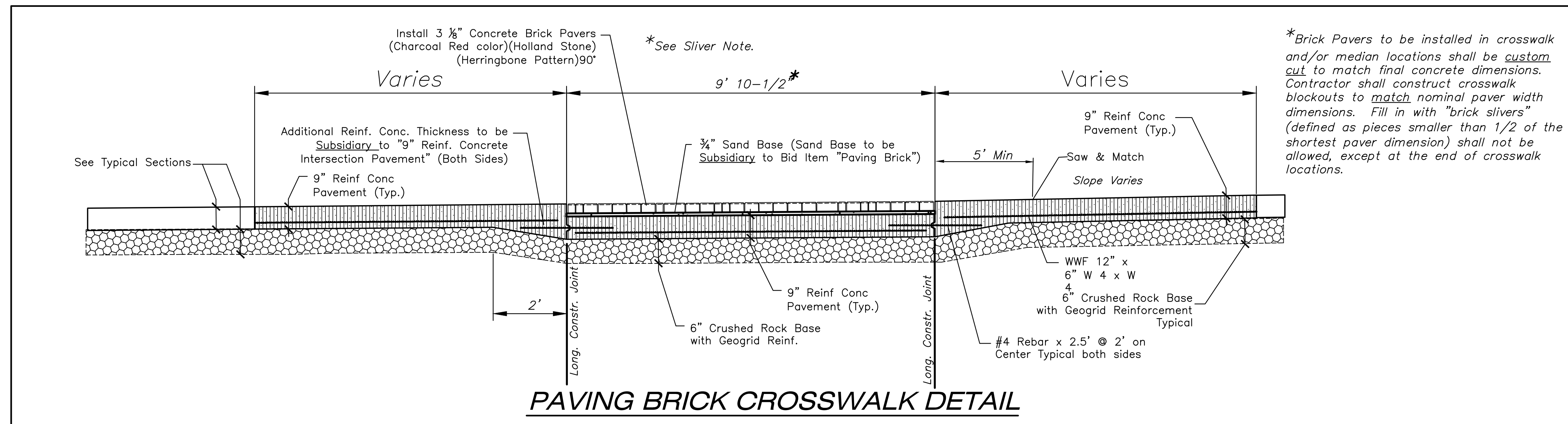

PAVING BRICK CROSSWALK DETAIL



<p>REVISD: OCTOBER 2015</p> <p>CURB & GUTTER & PAVING BRICK CROSSWALK DETAILS</p> <p>CITY ENGINEER GARY JANZEN, P.E.</p>		
PROJECT NUMBER 472-85245	OCA NUMBER 766434	DATE
CITY ENGINEER'S OFFICE CITY HALL - SEVENTH FLOOR 455 NORTH MAIN STREET WICHITA, KANSAS 67202-1620 (316) 268-4501		SHEET 05 OF 32

j:\Projects\2014\1401010462_Premier_Estancia\05-Civil\CAD\Draw\RESIDENTIAL\PH3\14462-ED-04-PH3A.dwg