

Combined Curb & Gutter (6")

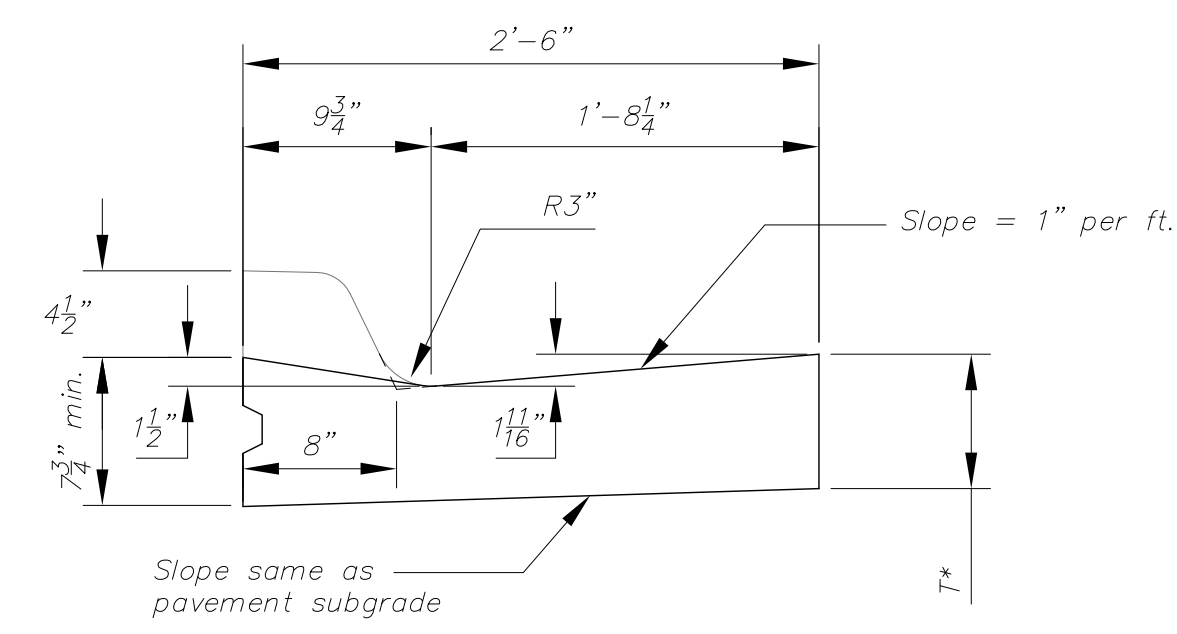

Combined Curb & Gutter (1 1/2")

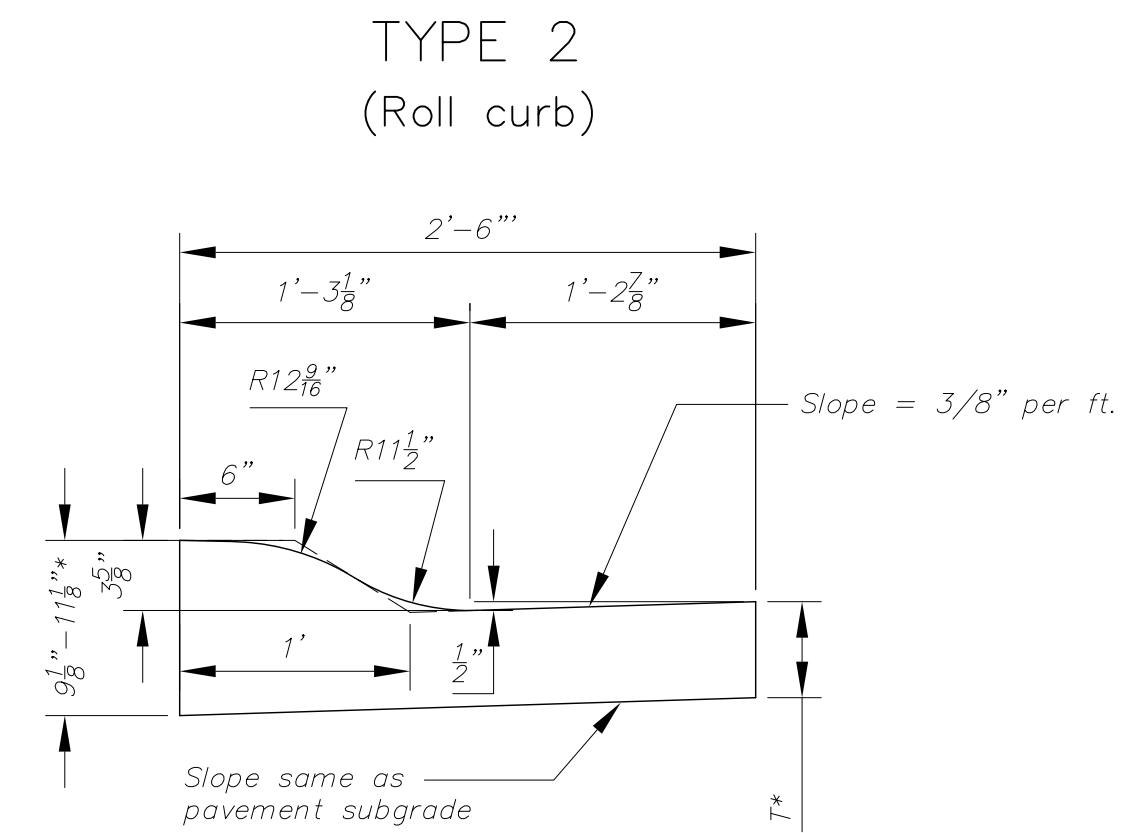

Combined Curb & Gutter (3 5/8")

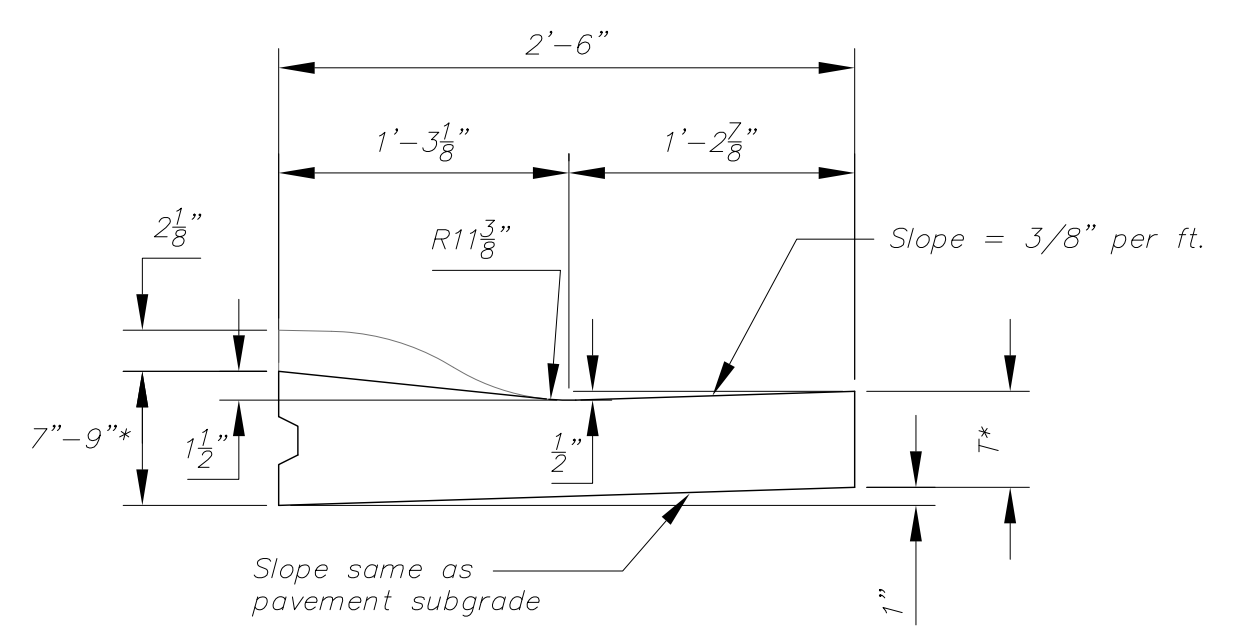

Combined Curb & Gutter (1 1/2")

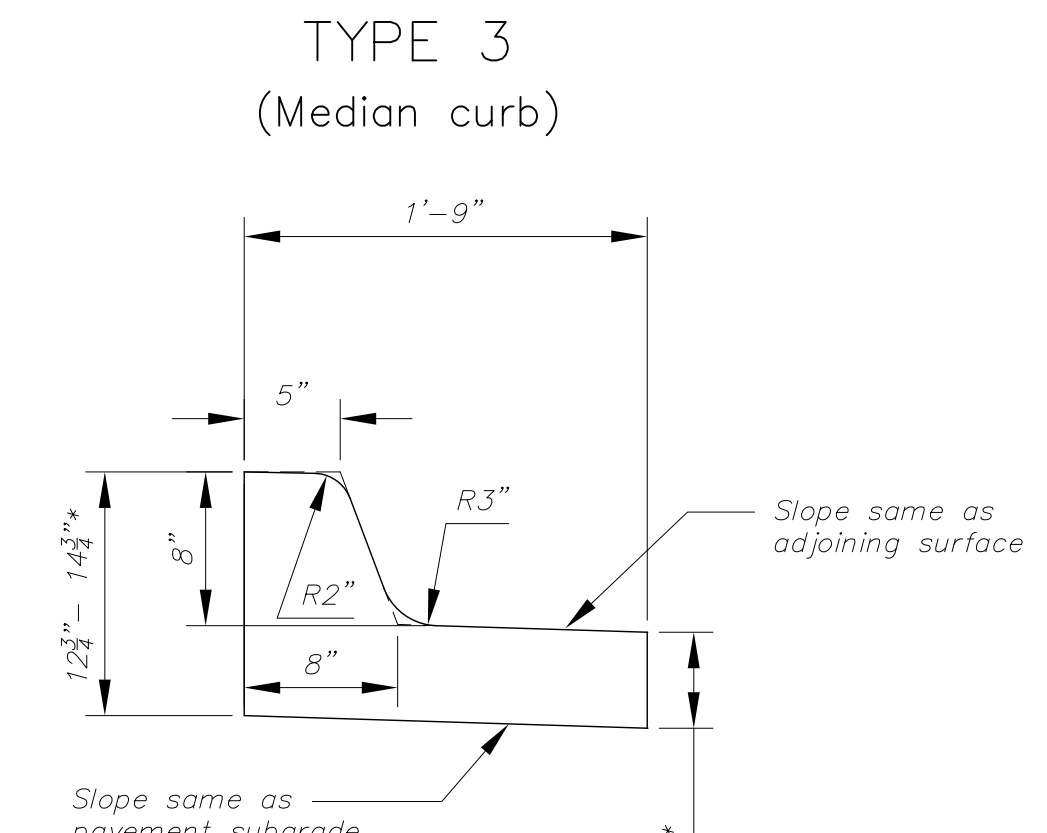

Combined Curb & Gutter (8")

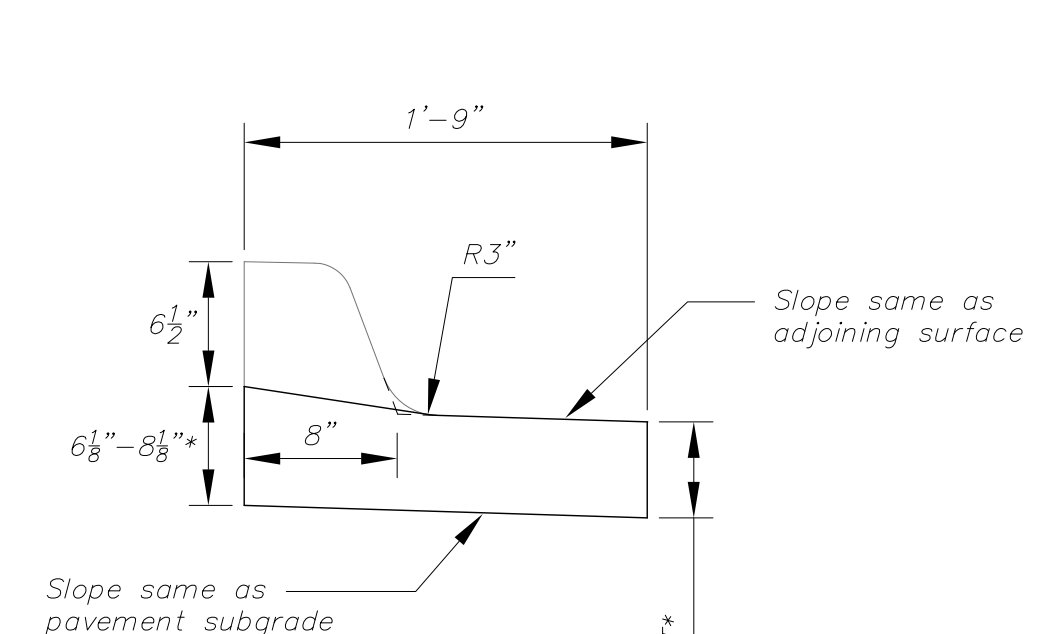

Combined Curb & Gutter (1 1/2")

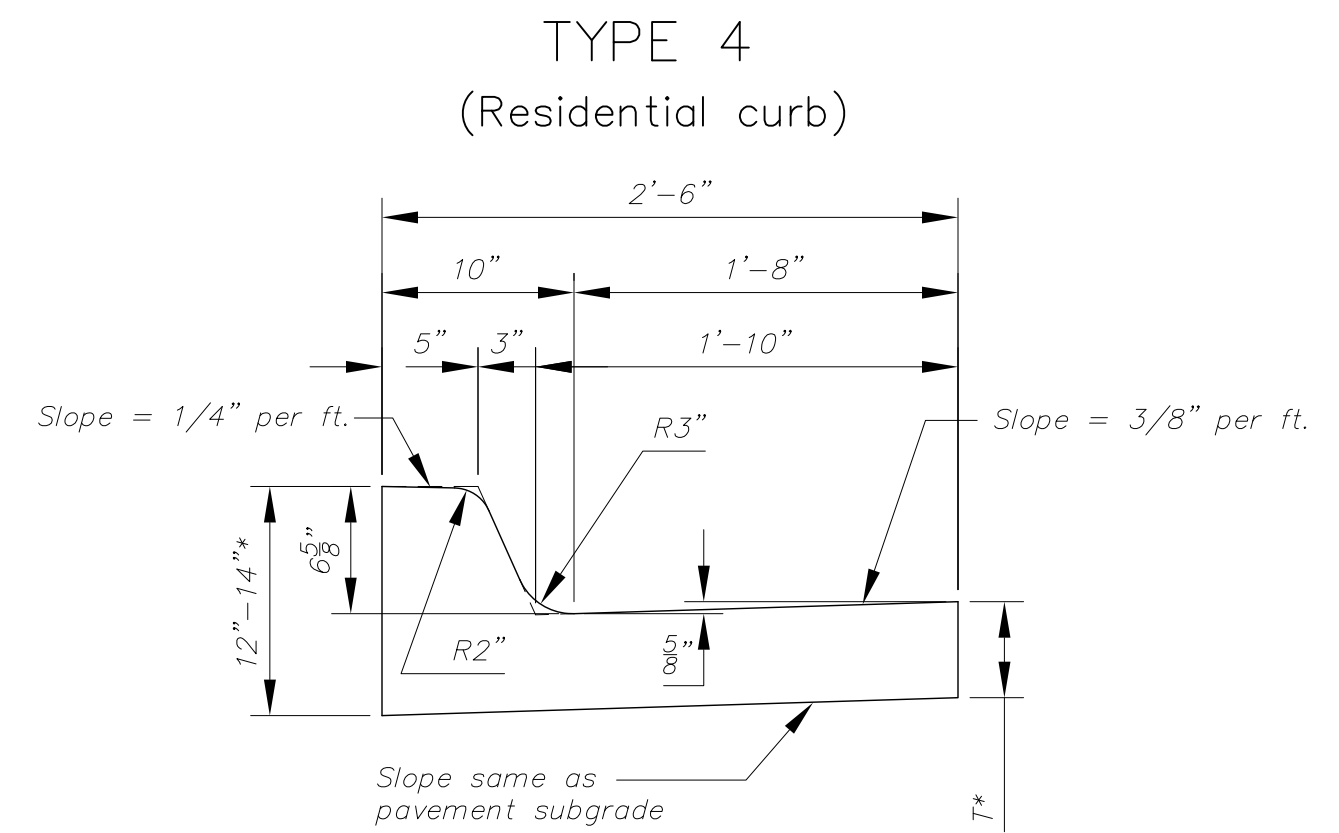

Combined Curb & Gutter (6 5/8")

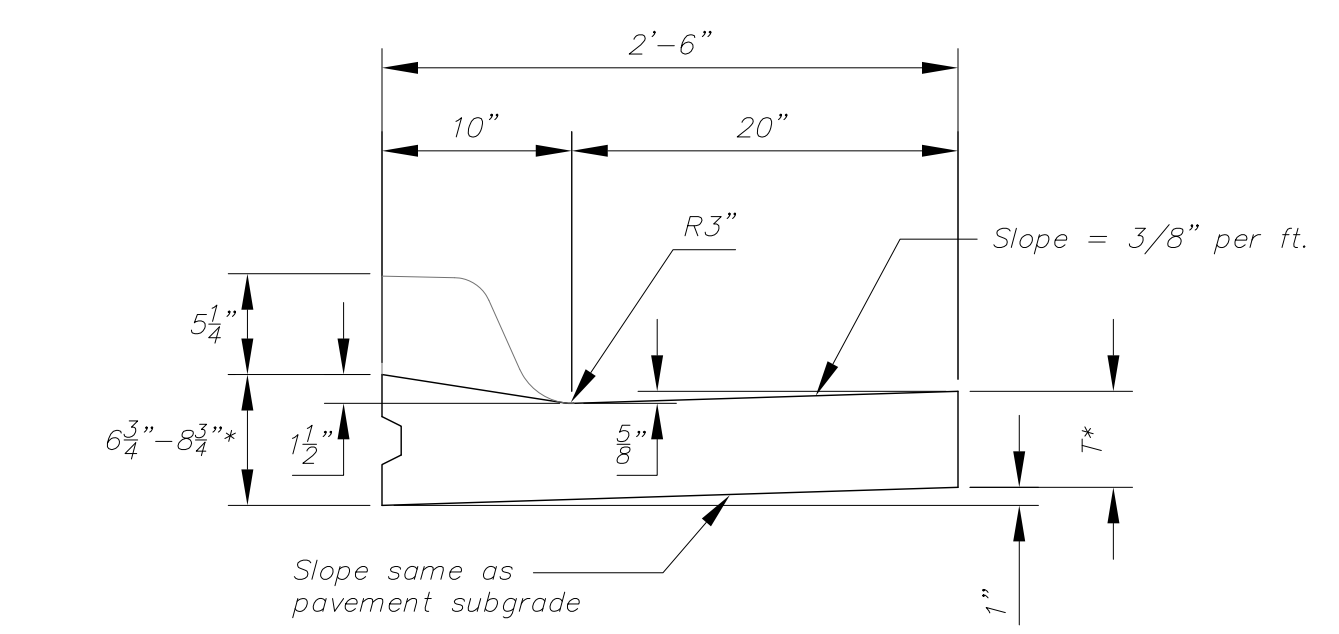

Combined Curb & Gutter (1 1/2")

T* = Thickness of curb to adjust with pavement thickness

GENERAL NOTES

- Expansion (isolation) joints shall be constructed a maximum of 300' apart and at all Pls, PCs, cul-de-sac quadrants, and ends of returns.
- Contraction joints shall be constructed a minimum of 12' apart.
- Joint sealer shall be required at all joints on arterial and industrial streets and at intersections on residential streets.

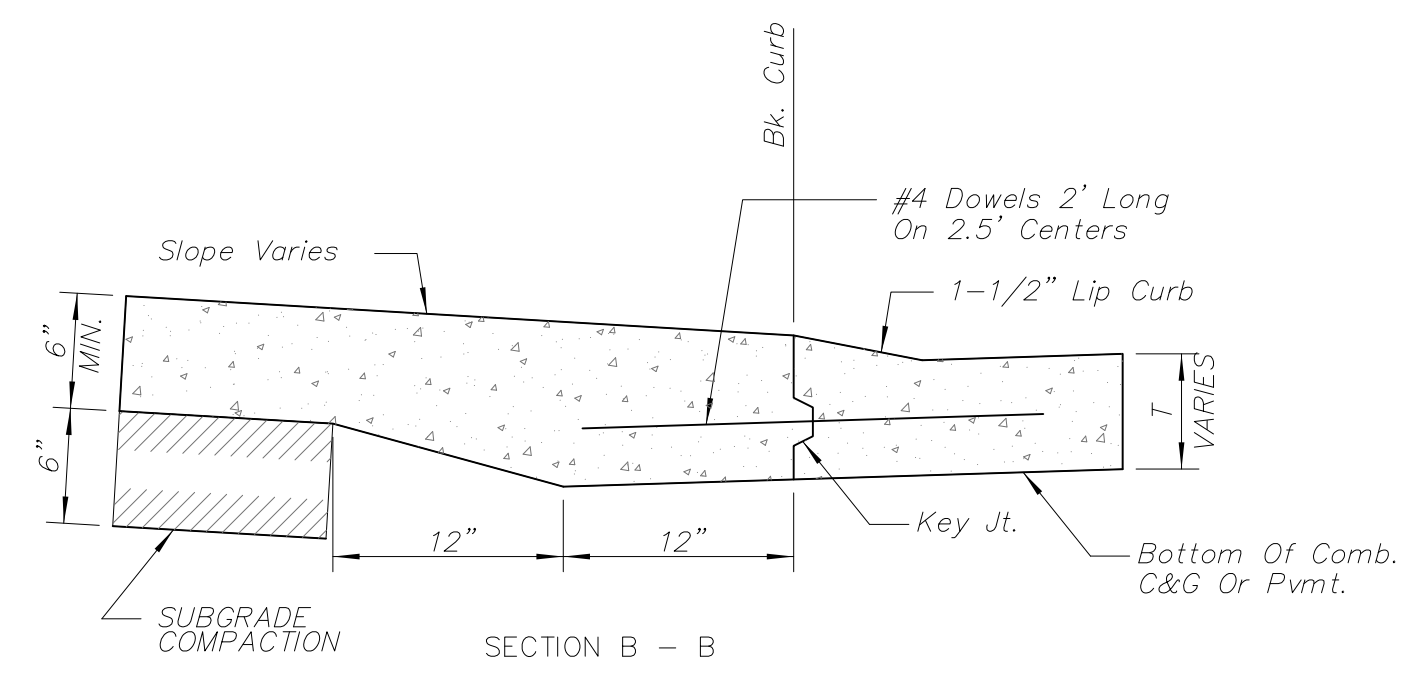

SECTION B - B
BACK OF CURB DETAIL

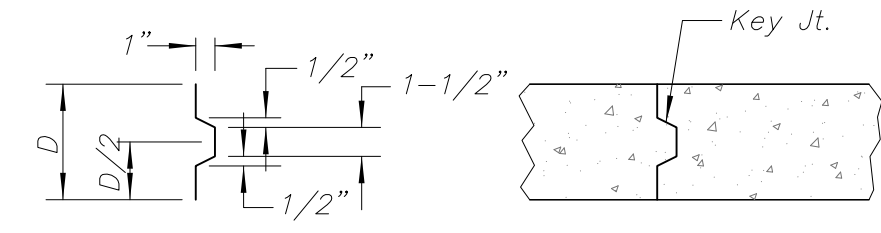

ALT. LONGITUDINAL CONSTRUCTION JOINT



EXPANSION JOINT (E.J.)

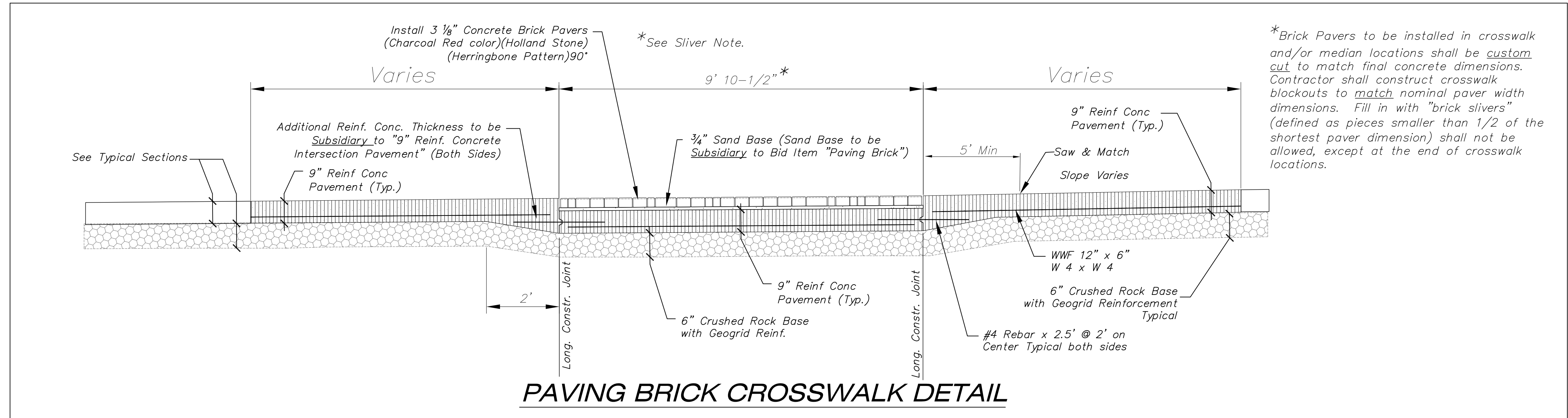

PAVING BRICK CROSSWALK DETAIL

CITY OF WICHITA
PUBLIC WORKS & UTILITIES
ENGINEERING DIVISION

<p>REVISD: OCTOBER 2015</p> <p>CURB & GUTTER & PAVING BRICK CROSSWALK DETAILS</p> <p>CITY ENGINEER GARY JANZEN, P.E.</p>		
PROJECT NUMBER	OCA NUMBER	DATE
<p>CITY ENGINEER'S OFFICE CITY HALL - SEVENTH FLOOR 455 NORTH MAIN STREET WICHITA, KANSAS 67202-1620 (316) 268-4501</p>		<p>SHEET 3 of 21</p>