

STANDARD WHEELCHAIR RAMP CONSTRUCTION DETAIL FOR STREETS WITH COMBINED CURB & GUTTER (TYPE A)

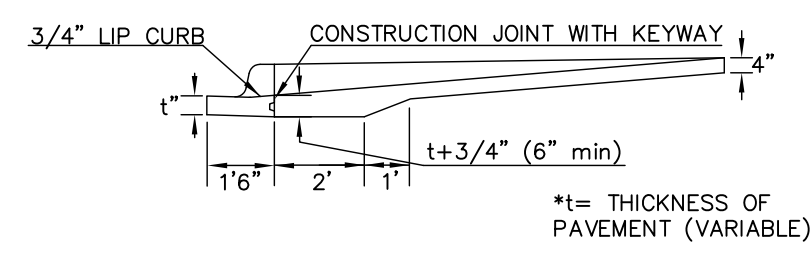

SECTION A-A

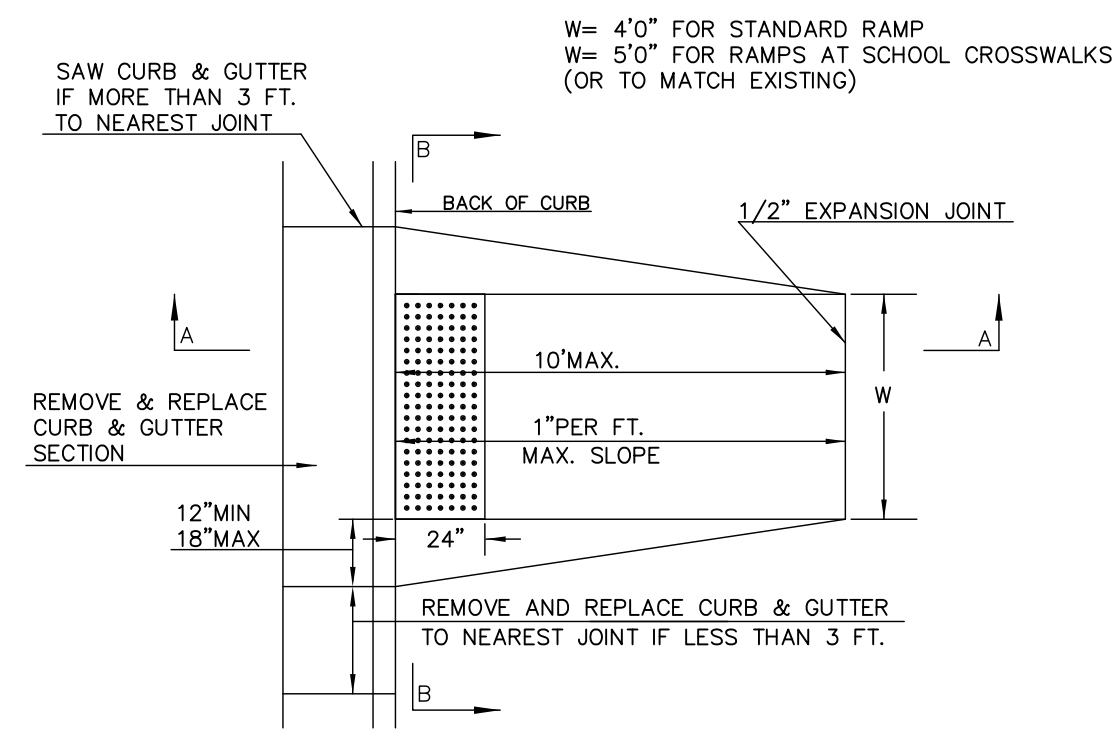
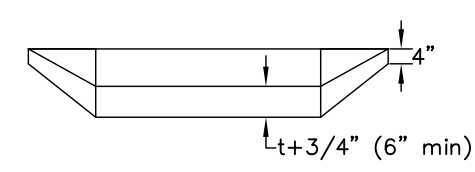

SECTION B-B

STANDARD WHEELCHAIR RAMP CONSTRUCTION DETAIL FOR CONCRETE STREETS WITH MONOLITHIC CURB (TYPE A)

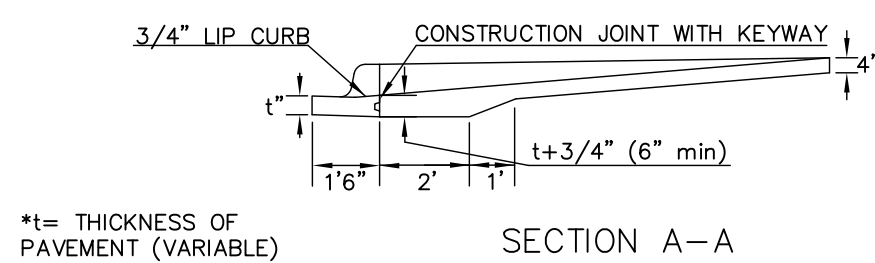
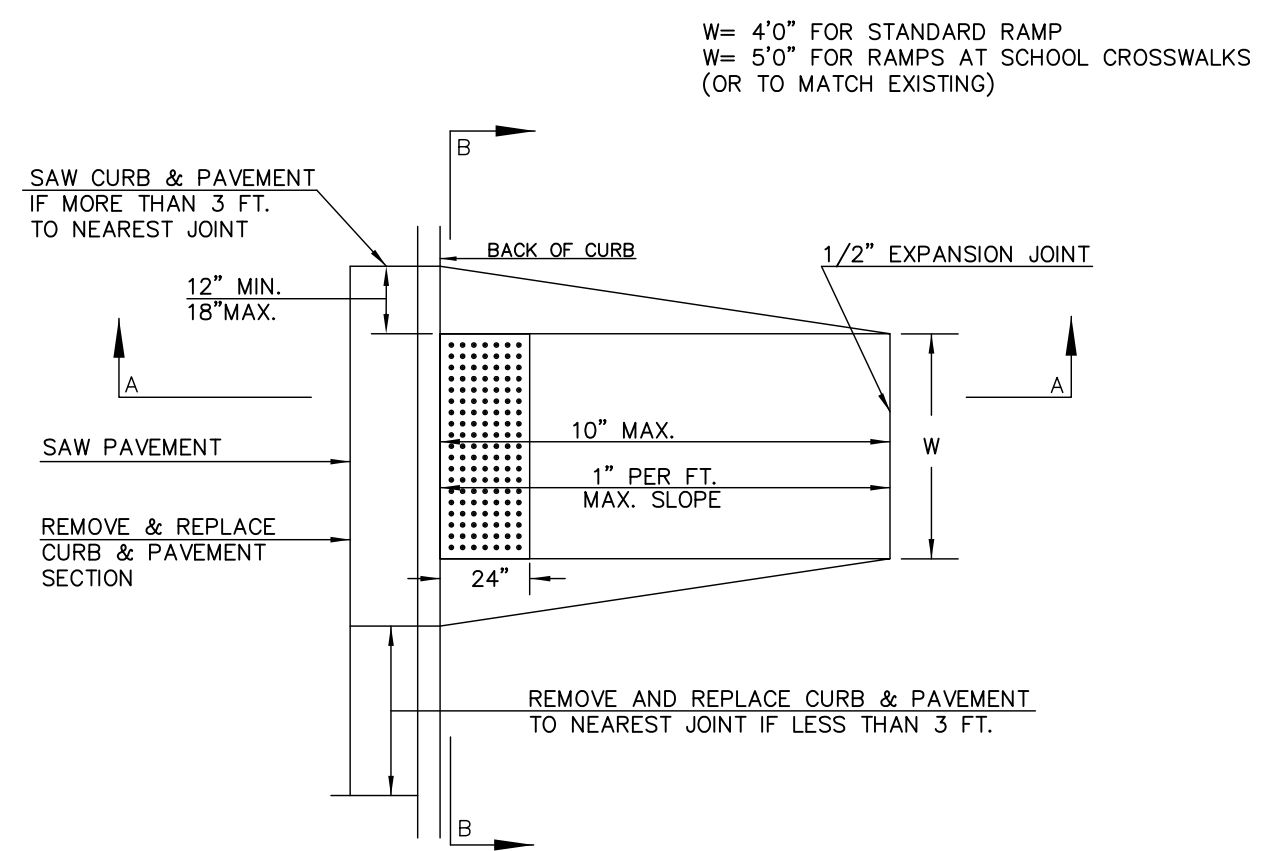

SECTION A-A

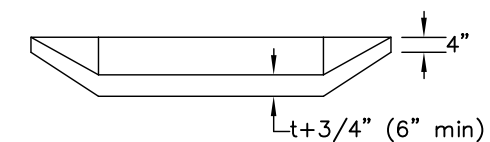

SECTION B-B

STANDARD WHEELCHAIR RAMP CONSTRUCTION DETAIL FOR STREETS WITH COMBINED CURB & GUTTER AND FULL WALK (TYPE B)

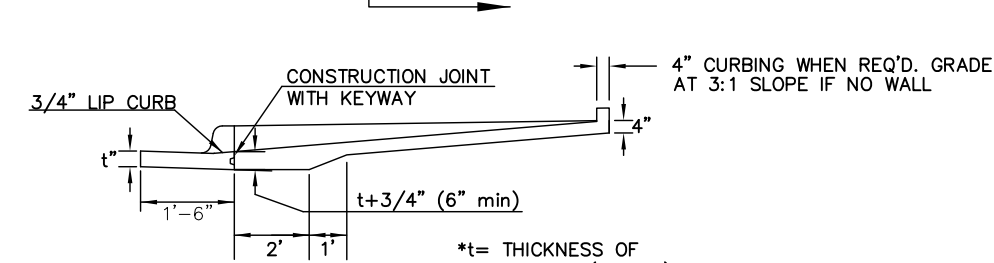
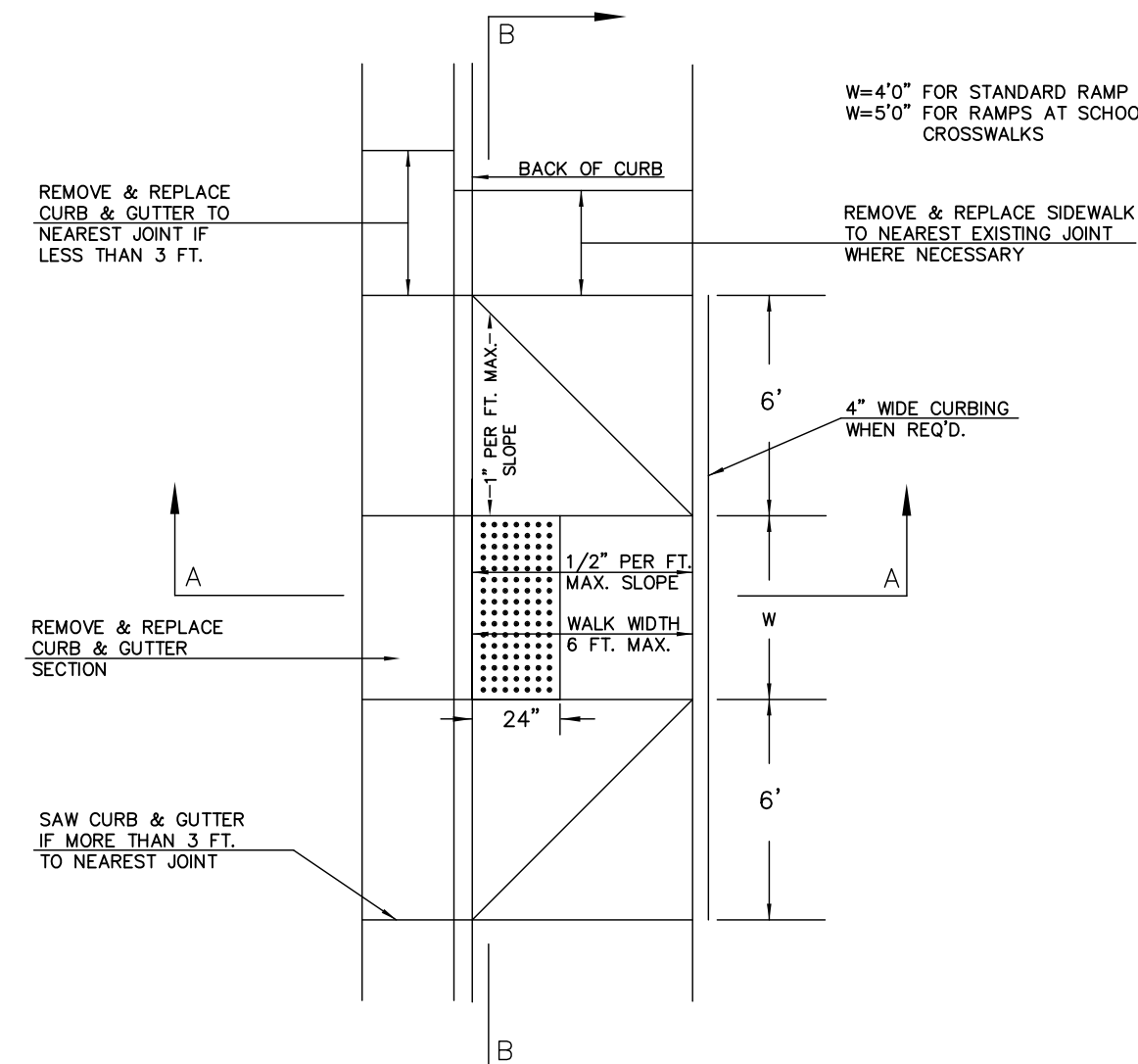

SECTION A-A

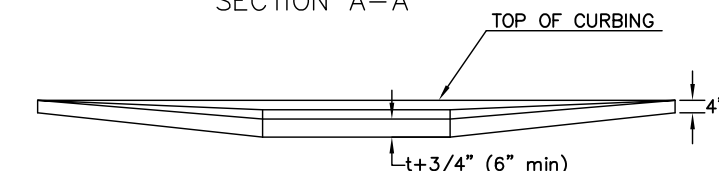

SECTION B-B

STANDARD WHEELCHAIR RAMP CONSTRUCTION DETAIL FOR STREETS WITH MONOLITHIC CURB AND FULL WALK (TYPE B)

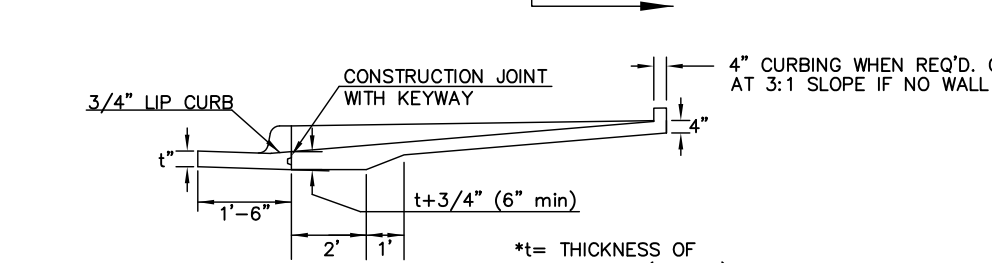
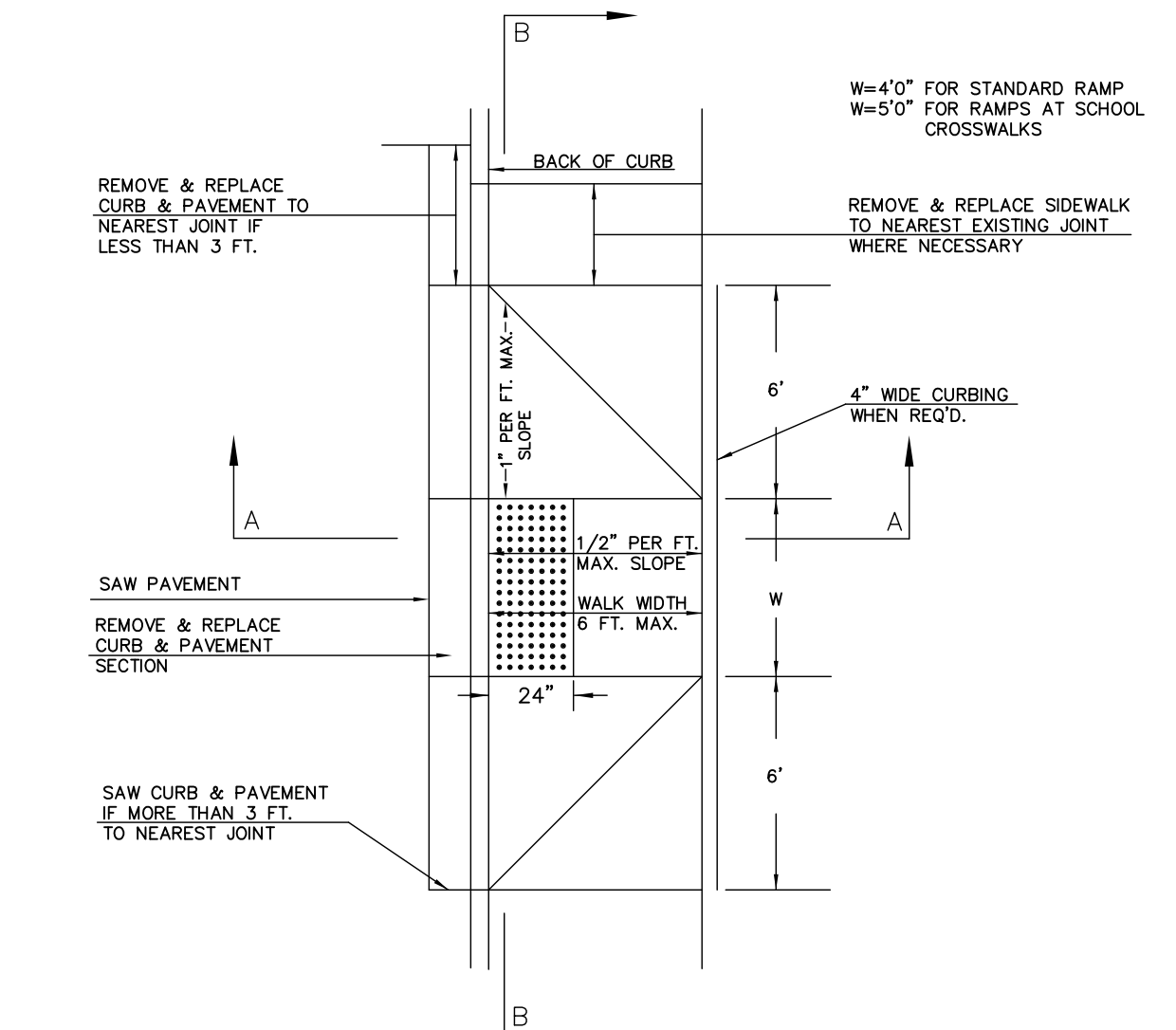

SECTION A-A

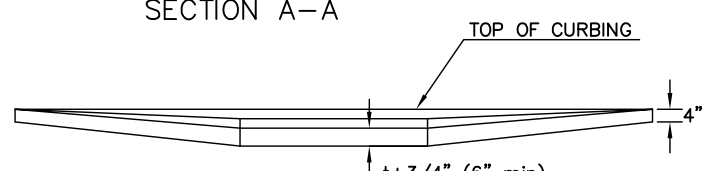

SECTION B-B

STANDARD WHEELCHAIR RAMP CONSTRUCTION DETAIL FOR STREET WITH COMBINED CURB AND GUTTER ON RADIUS WITH 6± FROM BACK OF CURB TO PROPERTY CORNER (TYPE C)

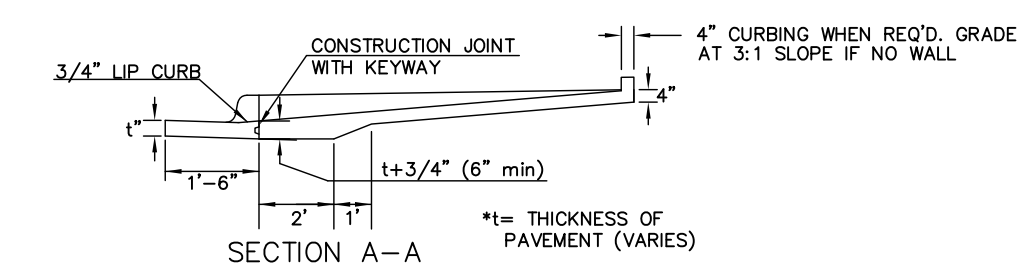
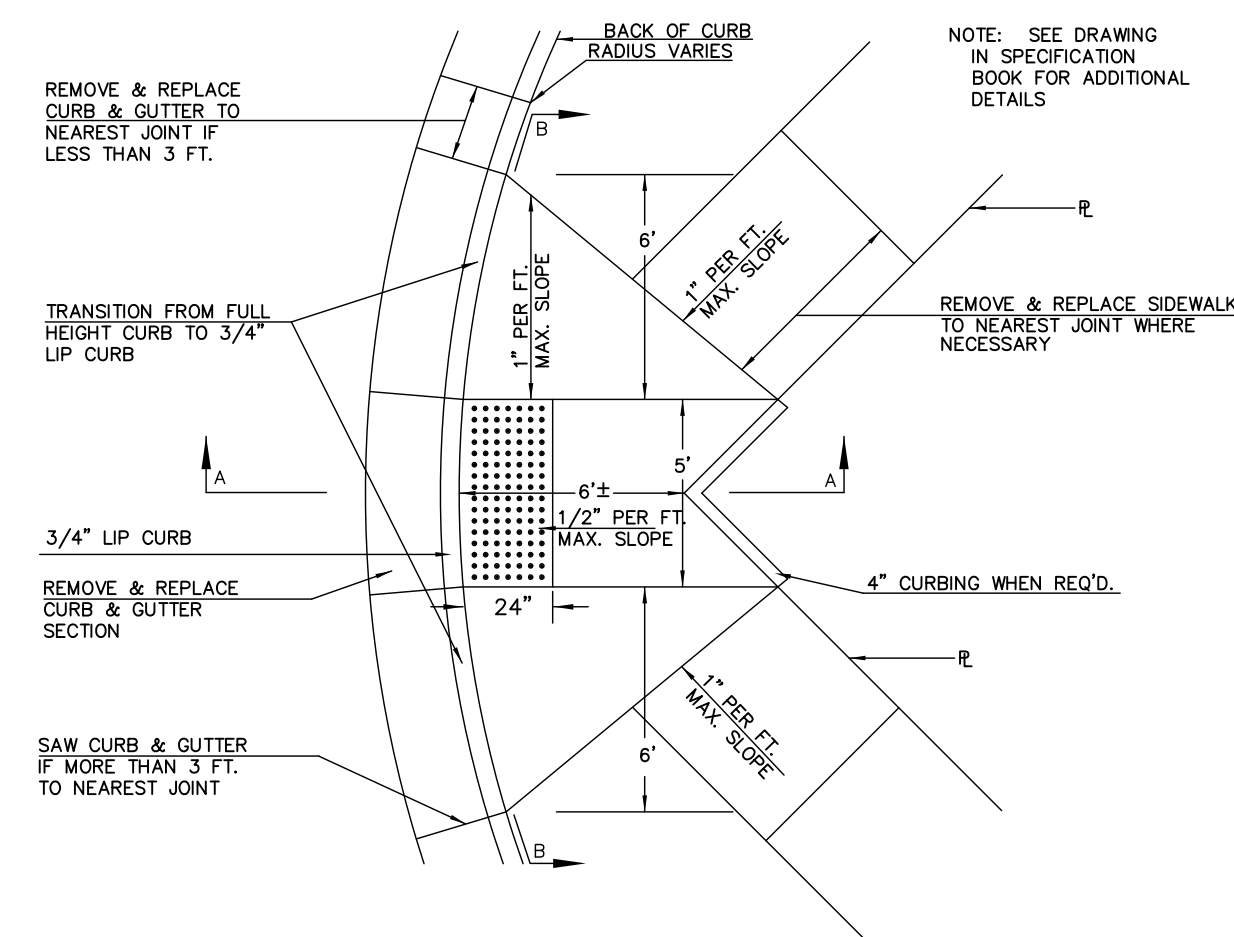

SECTION A-A

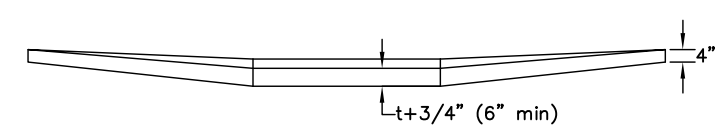

SECTION B-B

STANDARD WHEELCHAIR RAMP CONSTRUCTION DETAIL FOR STREET WITH MONOLITHIC CURB ON RADIUS WITH 6± FROM BACK OF CURB TO PROPERTY CORNER (TYPE C)

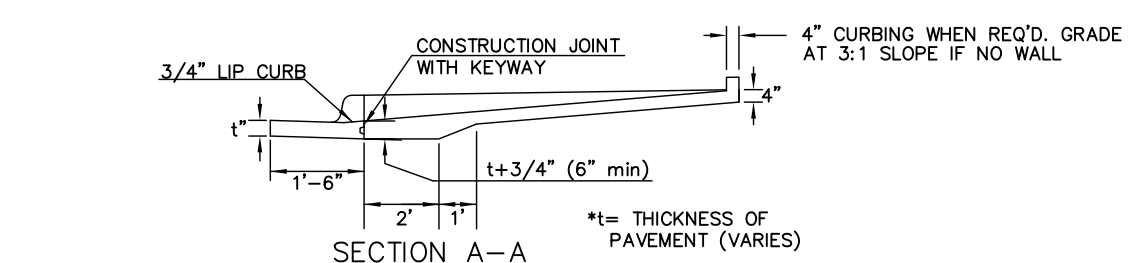
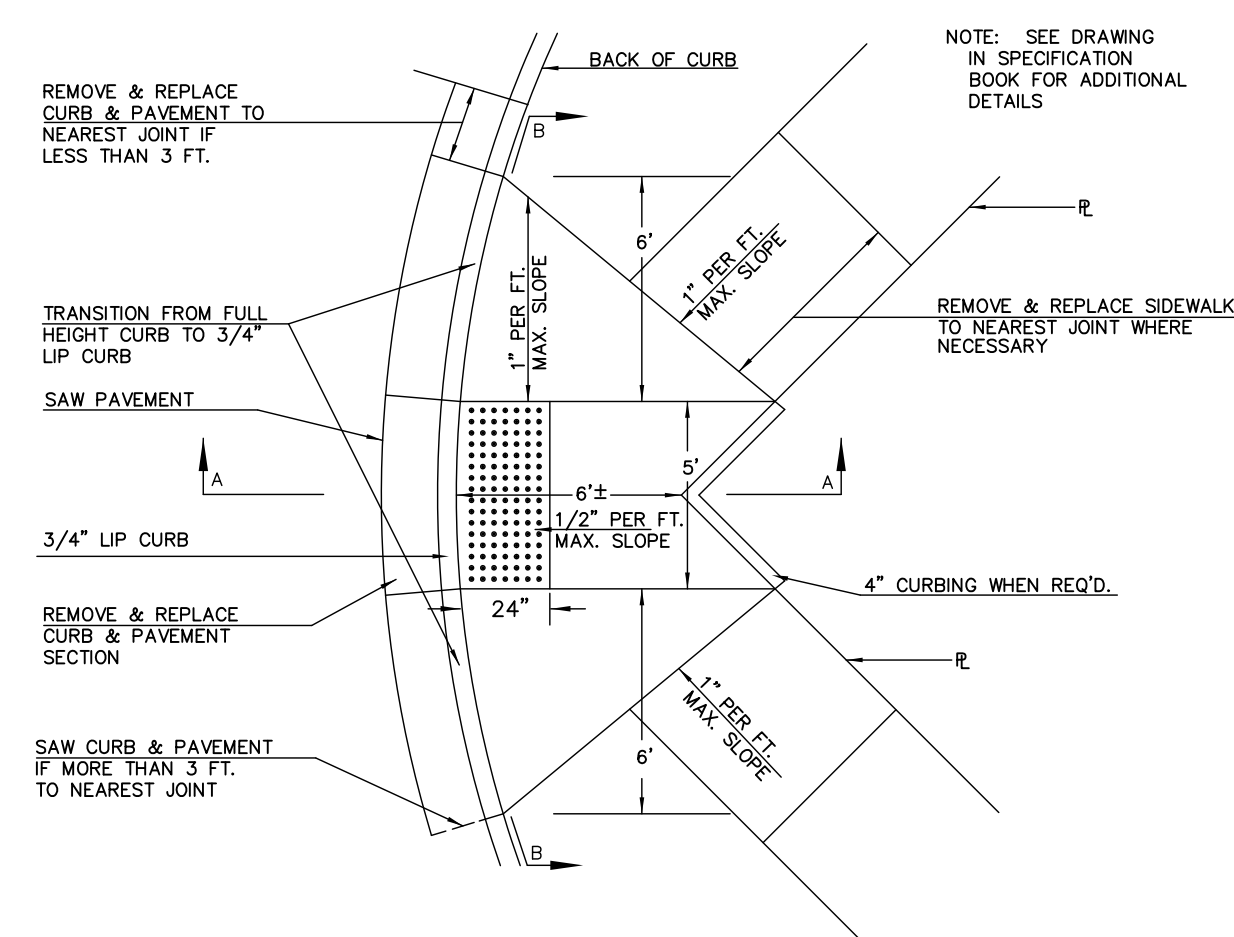

SECTION A-A

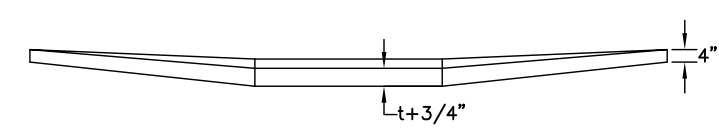

SECTION B-B

STANDARD WHEELCHAIR RAMP CONSTRUCTION DETAIL FOR STREETS WITH COMBINED CURB & GUTTER WITH ONE FULL SIDEWALK (TYPE D)

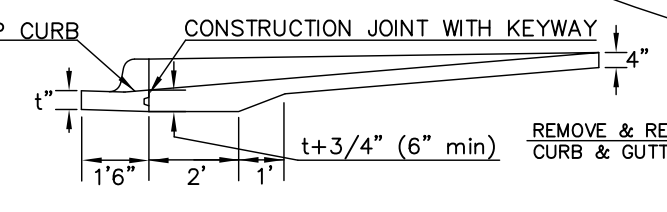
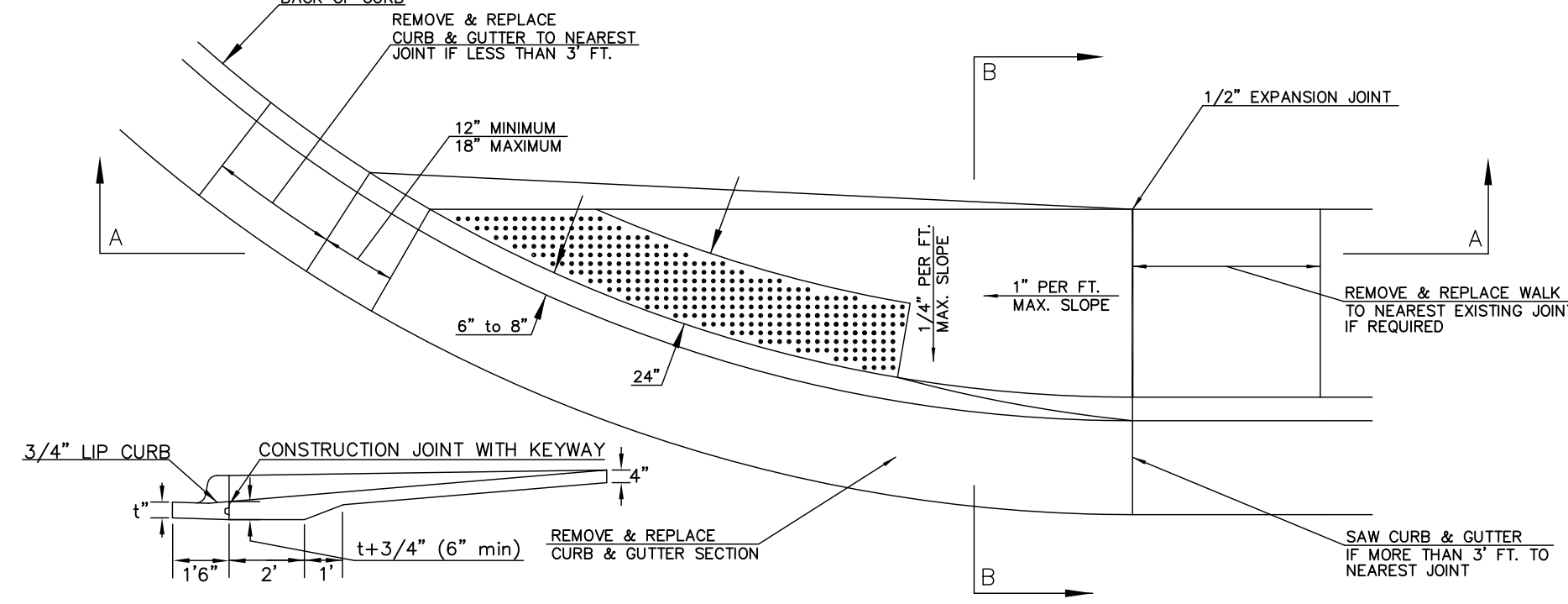

SECTION A-A

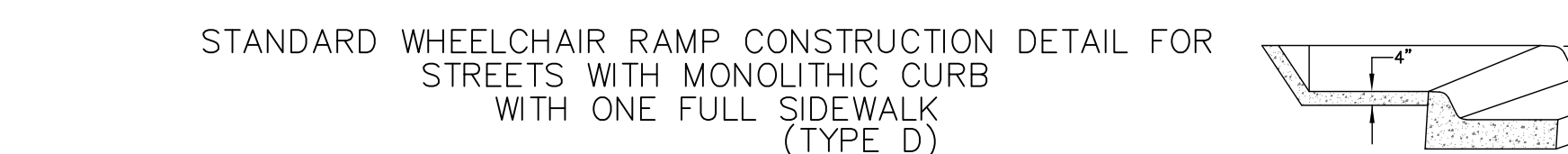

SECTION B-B

STANDARD WHEELCHAIR RAMP CONSTRUCTION DETAIL FOR STREETS WITH MONOLITHIC CURB WITH ONE FULL SIDEWALK (TYPE D)

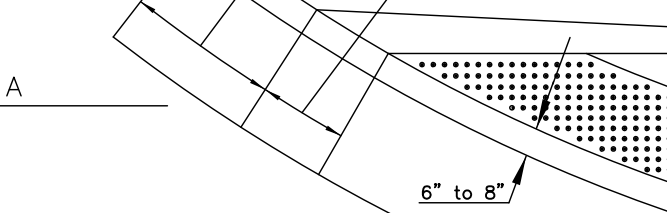
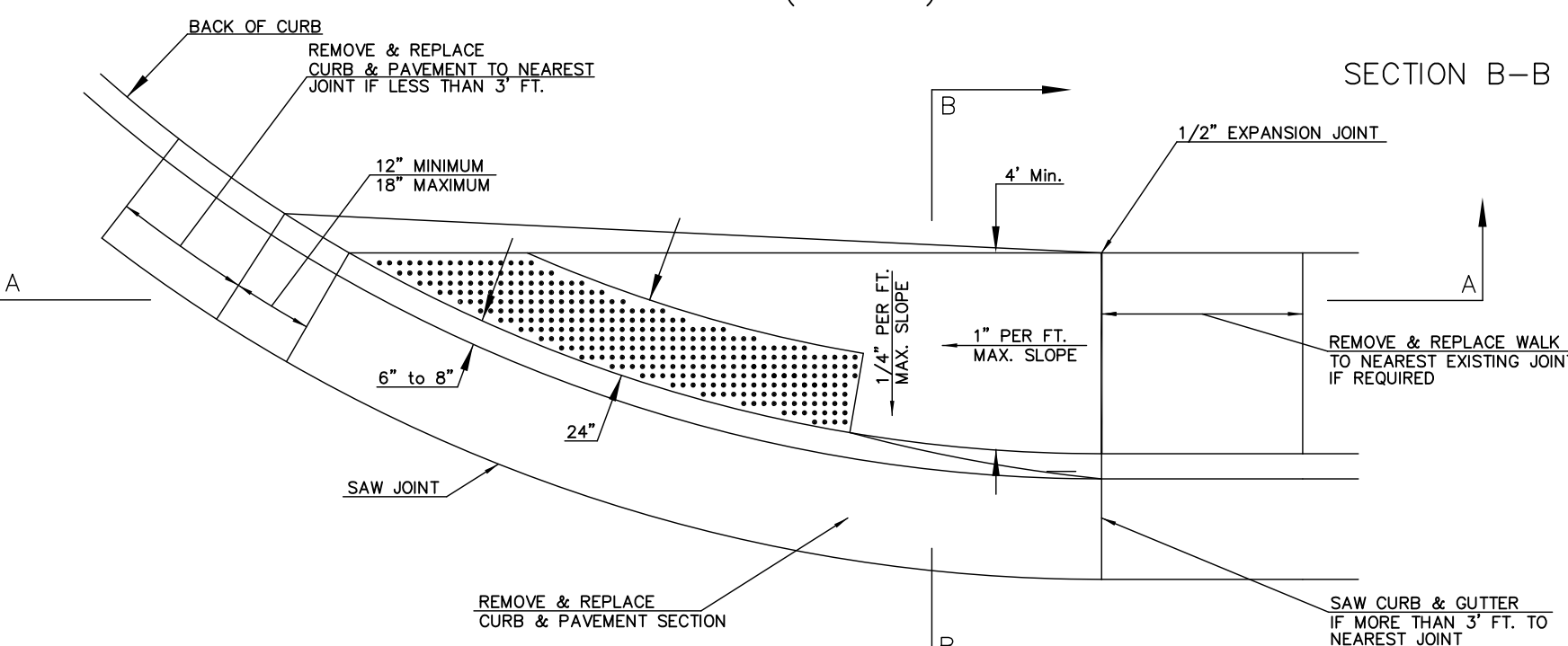

SECTION A-A

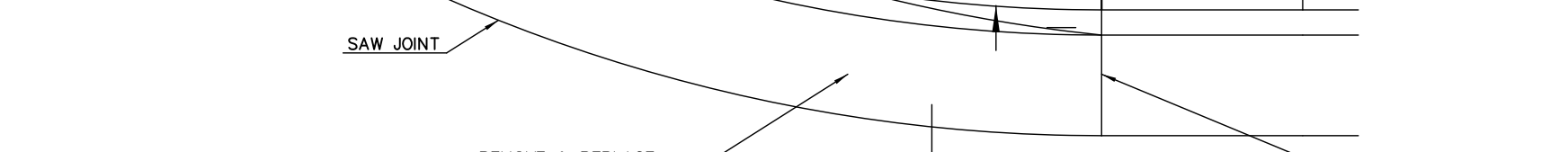

SECTION B-B

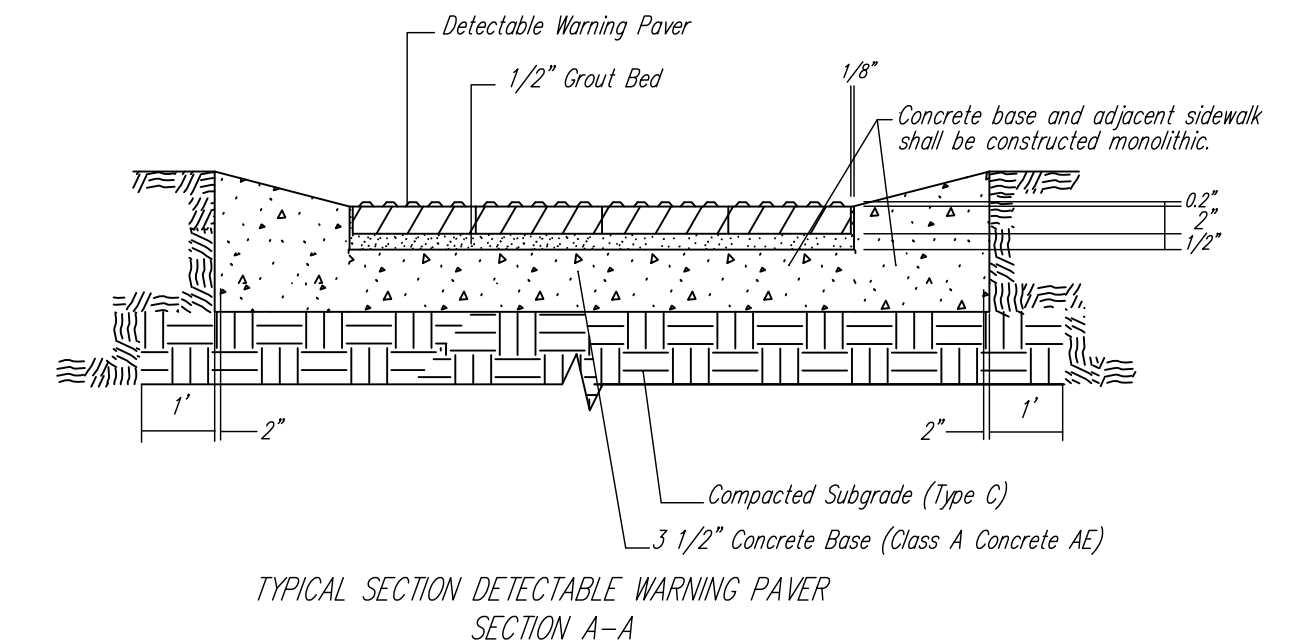

NOTE: HANOVER DETECTABLE WARNING PAVERS (OR AN APPROVED ALTERNATE) SHALL BE USED IN ALL WHEELCHAIR RAMPS. THE 11 3/4" RED 15' PAVER SHALL BE USED IN ALL APPLICATIONS.
HANOVER ARCHITECTURAL PRODUCTS
240 BENDER ROAD
HANOVER, PA 17331
1-717-637-0500
www.hanoverpavers.com

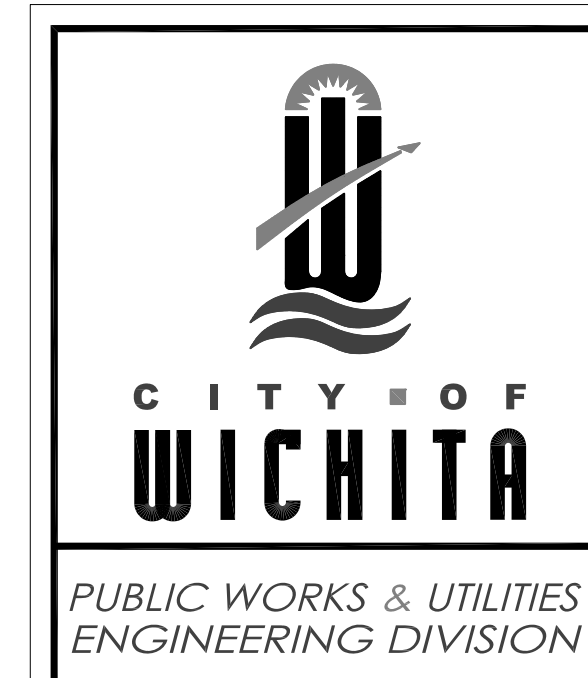
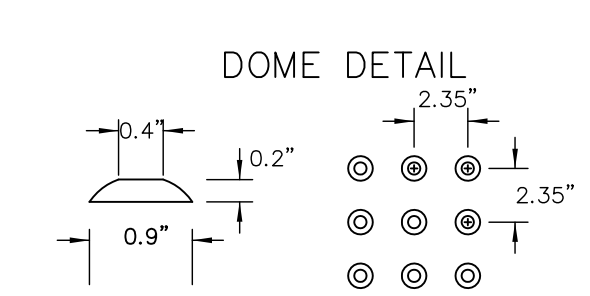

WHEELCHAIR RAMP DETAILS WITH DETECTABLE WARNING		
CITY ENGINEER GARY JANZEN, P.E.		
PROJECT NUMBER	OCA NUMBER	DATE 08/2013
CITY ENGINEER'S OFFICE CITY HALL - SEVENTH FLOOR 455 NORTH MAIN STREET WICHITA, KANSAS 67202-1620 (316) 268-4501		SHEET 9 of 17