

EXPANSION JOINT

NOTE: Extra Thickness to be Subsidiary to Price of Square Yards Pavement

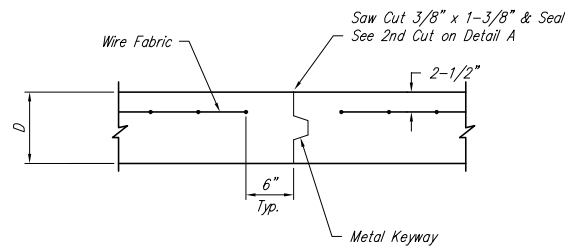

OPTIONAL CONTRACTION JOINT

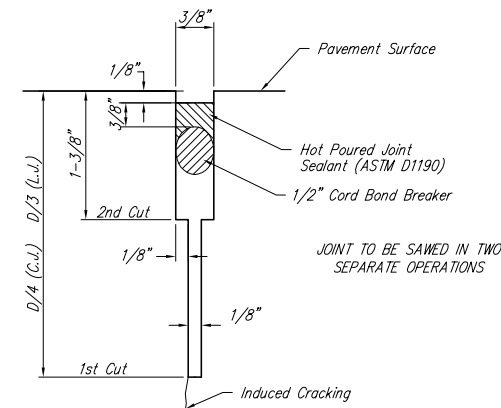

SAW JOINT DETAIL

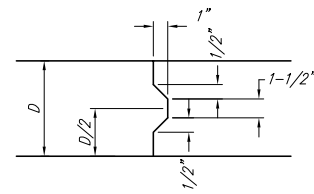

KEYWAY DETAIL

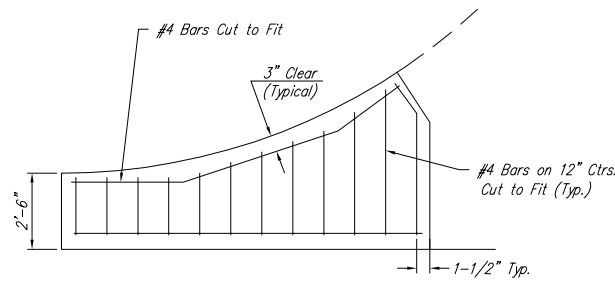

WING REINFORCING DETAIL

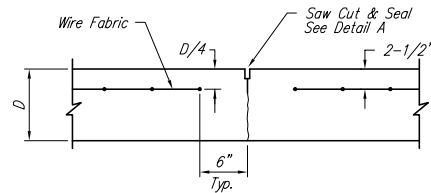

CONTRACTION JOINT DETAIL (C.J.)

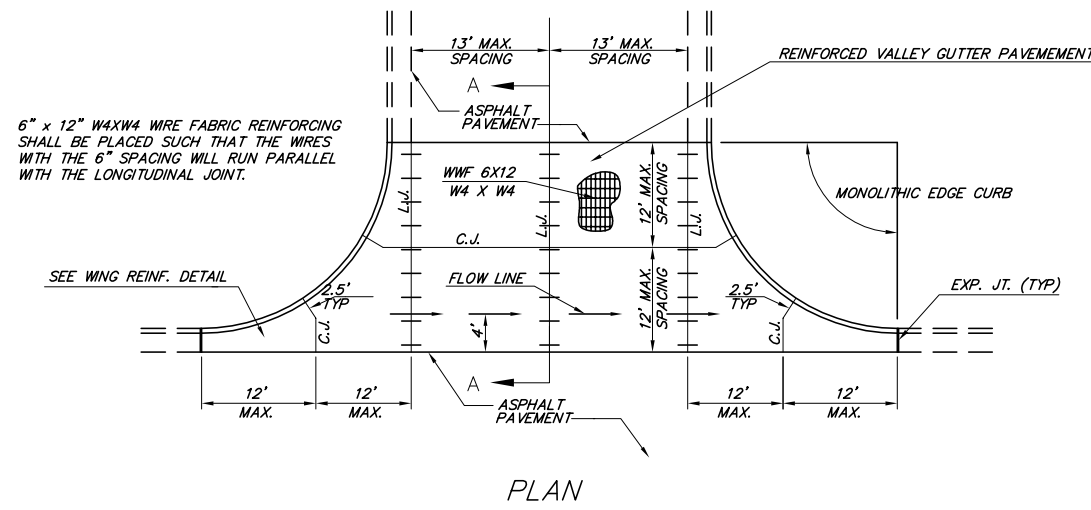

PLAN

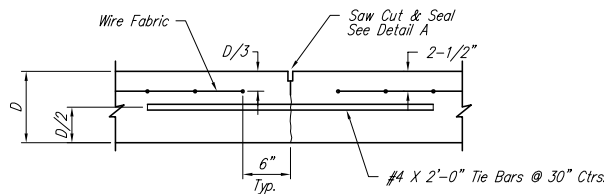

LONGITUDINAL JOINT DETAIL (L.J.)

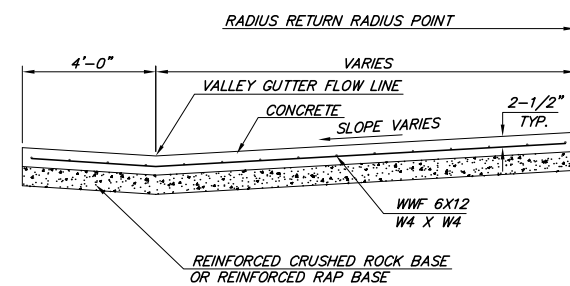

SECTION A-A

REINFORCED VALLEY GUTTER DETAIL

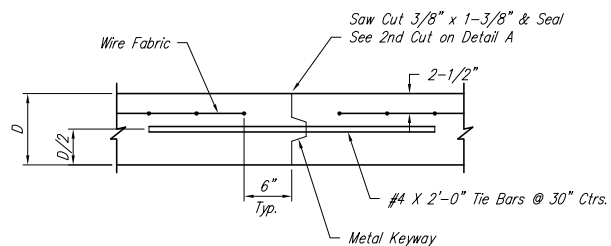

OPTIONAL LONGITUDINAL JOINT DETAIL (L.J.)

<p>THE CITY OF WICHITA CITY ENGINEER'S OFFICE 455 NORTH MAIN STREET WICHITA, KANSAS 67202 (316) 268-4501 (316) 268-4114 FAX</p>	VALLEY GUTTER DETAILS	
	WHEELCHAIR RAMP DETAILS	
	PROJECT NUMBER	OCA #
DATE MAR 96	SHEET 4 OF 16	