

**EXPANSION JOINT**

NOTE: Extra Thickness to be Subsidiary to Price of Square Yards Pavement

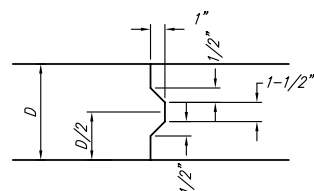

**KEYWAY DETAIL**

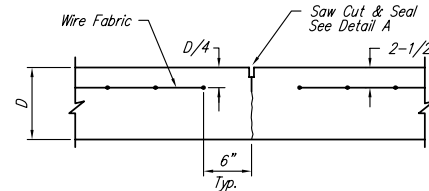

**CONTRACTION JOINT DETAIL (C.J.)**

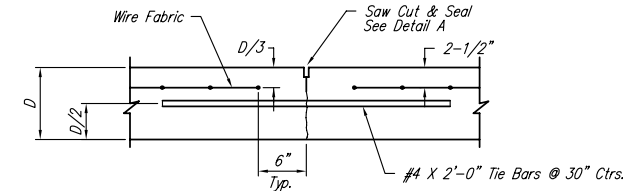

**LONGITUDINAL JOINT DETAIL (L.J.)**

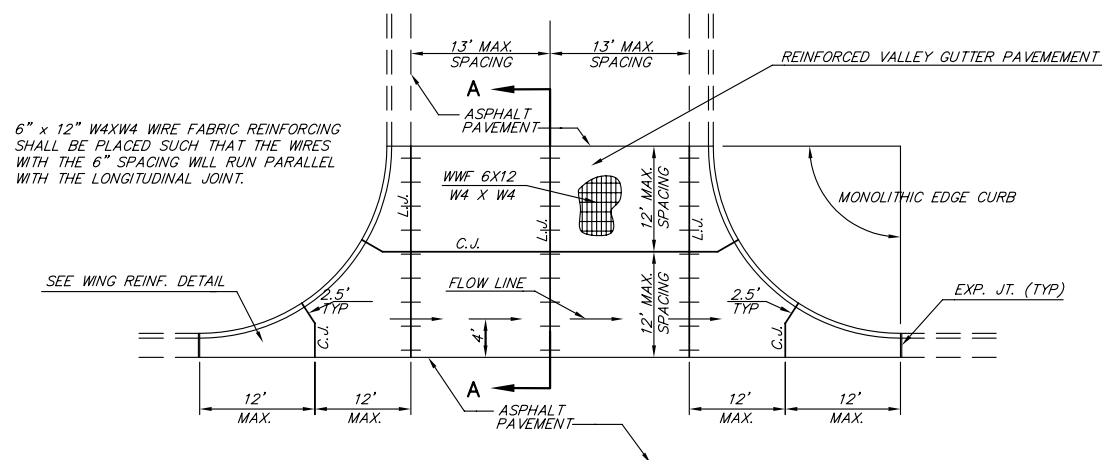

**PLAN**

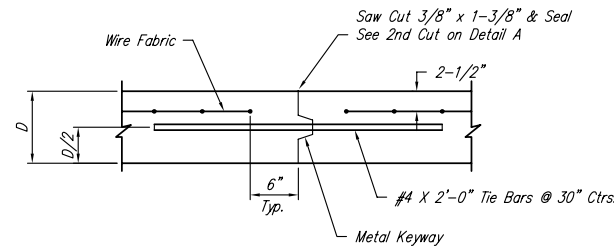

**OPTIONAL LONGITUDINAL JOINT DETAIL (L.J.)**

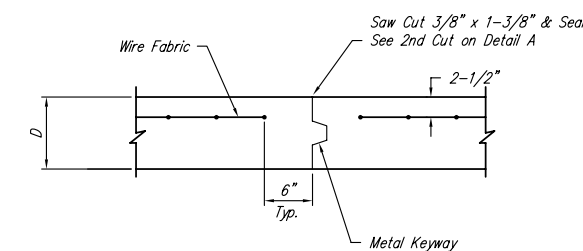

**OPTIONAL CONTRACTION JOINT**

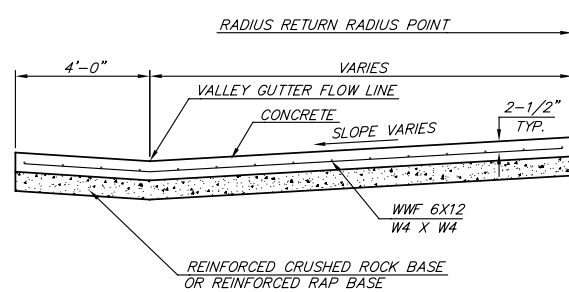

**SECTION A-A**

**REINFORCED VALLEY GUTTER DETAIL**

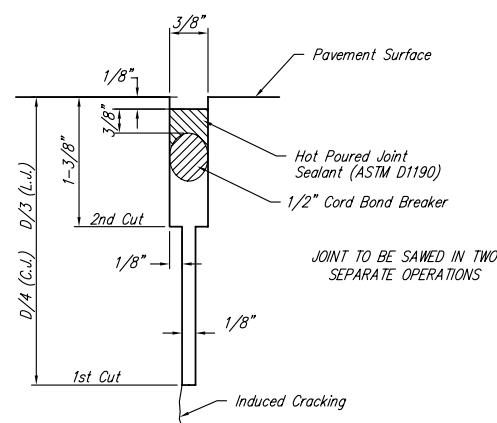

**SAW JOINT DETAIL**

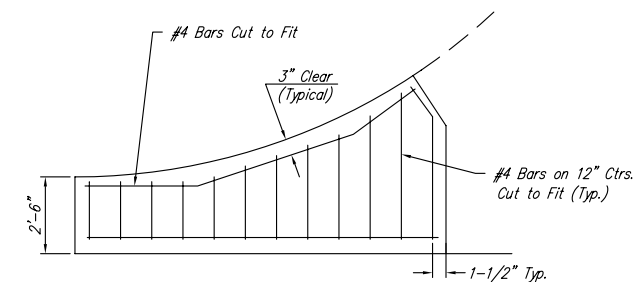

**WING REINFORCING DETAIL**

<p>THE CITY OF WICHITA</p> <p>CITY ENGINEER'S OFFICE 455 NORTH MAIN STREET WICHITA, KANSAS 67202 (316) 266-4801 (316) 266-4114 FAX</p>	<b>VALLEY GUTTER DETAILS</b>	
	JAMES L. ARMOUR, P.E. - CITY ENGINEER	
	PROJECT NUMBER 472-84214	INDEX CODE 765962
	DATE OCTOBER 2005	SHEET NUMBER 4 / 29

G:\CIVIL\99116.dwg\PAV\PH13.PART\99116ED3