

EXPANSION JOINT

NOTE: Extra Thickness to be Subsidiary to Price of Square Yards Pavement

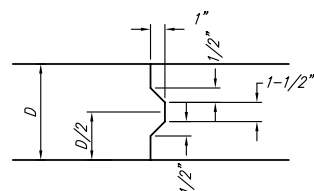

KEYWAY DETAIL

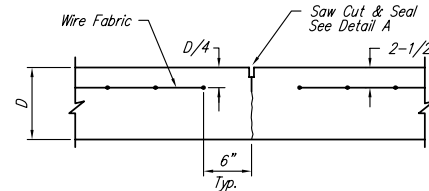

CONTRACTION JOINT DETAIL (C.J.)

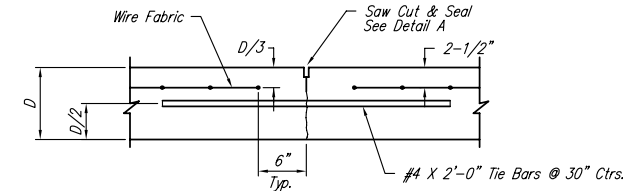

LONGITUDINAL JOINT DETAIL (L.J.)

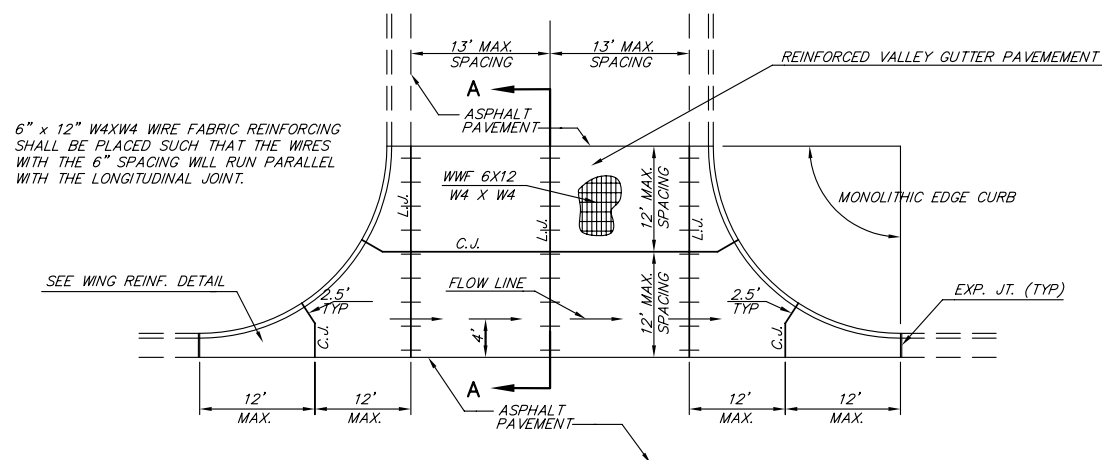

PLAN

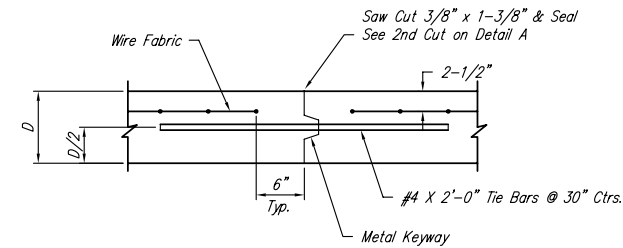

OPTIONAL LONGITUDINAL JOINT DETAIL (L.J.)

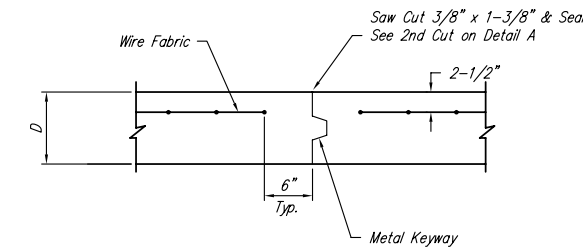

OPTIONAL CONTRACTION JOINT

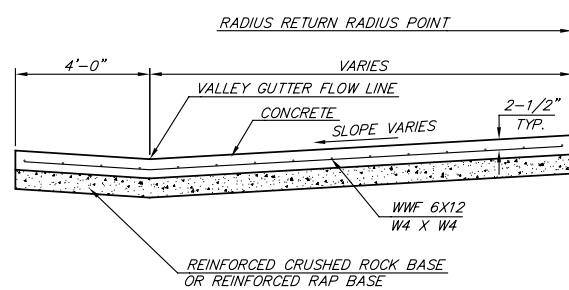

SECTION A-A

REINFORCED VALLEY GUTTER DETAIL

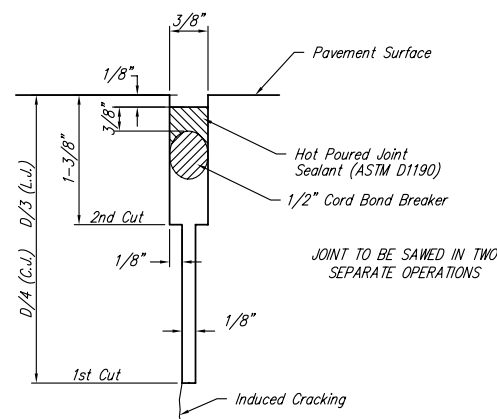

SAW JOINT DETAIL

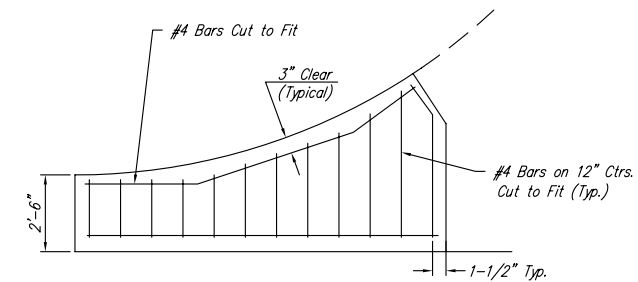

WING REINFORCING DETAIL

<p>THE CITY OF WICHITA</p> <p>CITY ENGINEER'S OFFICE CITY HALL - SEVENTH FLOOR 455 NORTH MAIN STREET WICHITA, KANSAS 67202 (316) 268-4501 (316) 268-4114 FAX</p>	VALLEY GUTTER DETAILS	
	JAMES L. ARMOUR, CITY ENGINEER	
	PROJECT NUMBER 472-84279	INDEX CODE 765996
	DATE AUG 2006	Sheet 4 of 43

G:\CIVIL\99118\dwg\PAV\PH12\99118ED3