

SECTION B-B

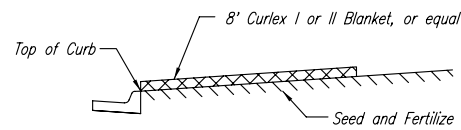

SECTION A-A

Install 8' wide Curlex I or II Excelsior Blanket, or equal, on prepared surface back of curb. Edge of blanket will be at back of curb. Install per manufacturer's recommendation, including staples. (See detail)

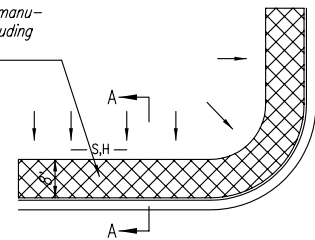

SOUTH STREET

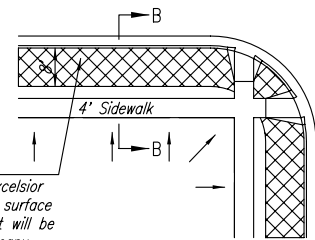

Install 8' wide Curlex I or II Excelsior Blanket, or equal, on prepared surface back of curb. Edge of blanket will be at back of curb. Install per manufacturer's recommendation, including staples. (See detail)

- NOTES:
- EXCELSIOR MAT TO BE INSTALLED WHEN SOD IS NOT SPECIFIED ON PROJECT.
  - EXCELSIOR BLANKET TO BE INSTALLED OVER SEED AND FERTILIZER, AS SPECIFIED IN THE PROJECT SPECIFICATIONS.
  - AFTER INSTALLATION OF EXCELSIOR BLANKET, AT LOCATIONS WHERE CONCENTRATED FLOW CARRIES SEDIMENT OVER THE CURB AND INTO THE GUTTER, SUPPLEMENTAL EROSION CONTROL DEVICES WILL BE INSTALLED BY THE CONTRACTOR AS NEEDED, TO FIX THE PROBLEM.

BACK OF CURB PROTECTION DETAIL

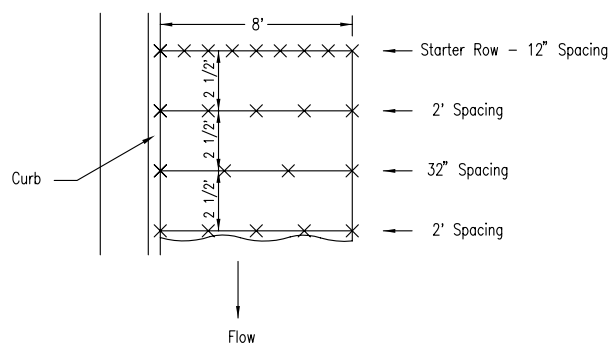

NOTES: Use 6" seam overlap

DETAILS FOR CURLEX I OR II BLANKETS

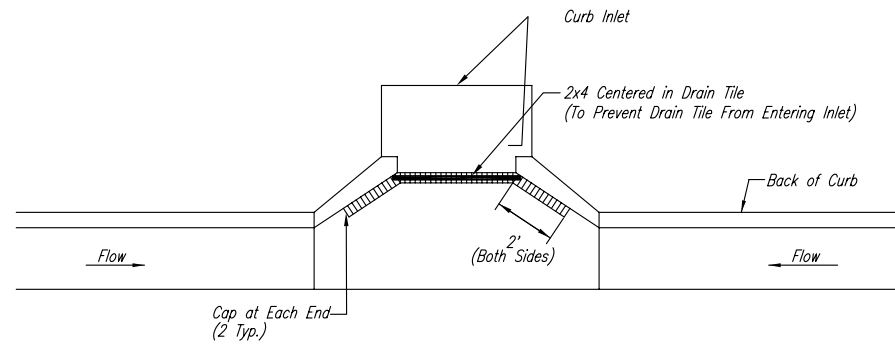

Note: Place 4" perforated PVC pipe, filled with 1/2"-1" dia. gravel, in front of curb inlet as shown.

2X4 LENGTH	INLET TYPE	INLET OPENING
5'-6"	1-A	5'-0"
10'-6"	1-A	10'-0"
15'-6"	1-A	15'-0"

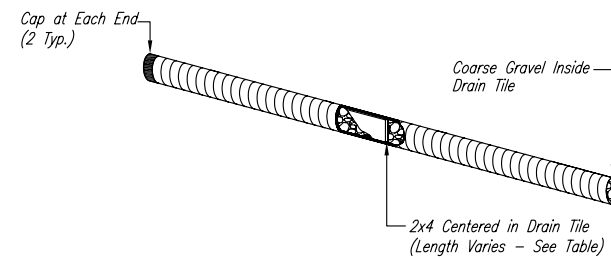

CURB INLET PROTECTION  
4" PERFORATED PIPE W/ GRAVEL

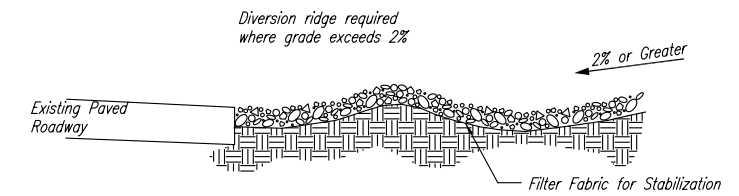

SECTION C-C

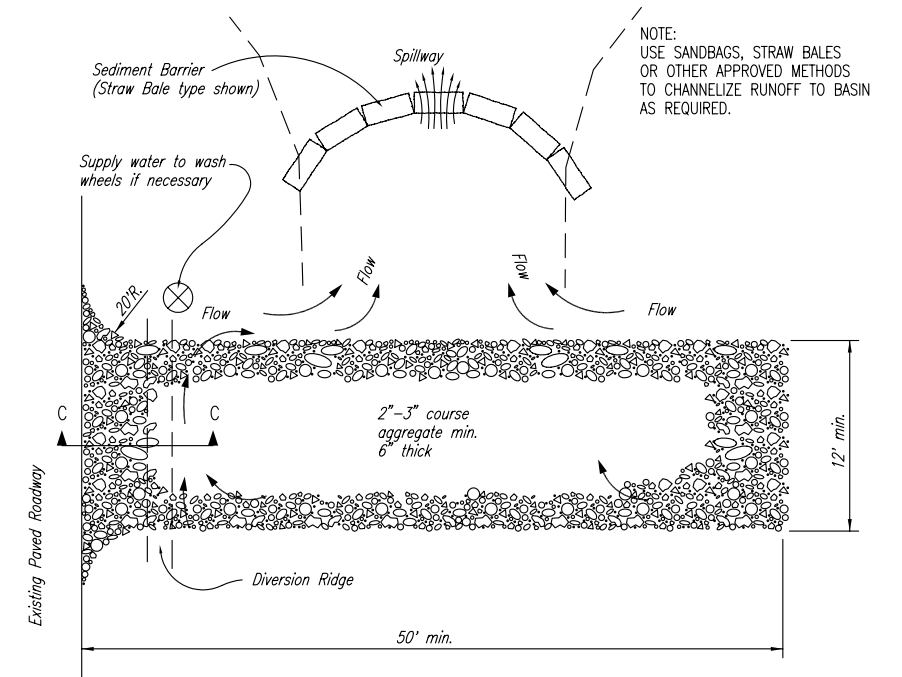

STABILIZED CONSTRUCTION ENTRANCE

- NOTES:
- THE ENTRANCE SHALL BE MAINTAINED IN A CONDITION THAT WILL PREVENT TRACKING OR FLOWING OF SEDIMENT ONTO PUBLIC RIGHTS-OF-WAY. THIS MAY REQUIRE TOP DRESSING, REPAIR AND/OR CLEANOUT OF ANY MEASURES USED TO TRAP SEDIMENT.
  - WHEN NECESSARY, WHEELS SHALL BE CLEANED PRIOR TO ENTRANCE ONTO PUBLIC RIGHT-OF-WAY.
  - WHEN WASHING IS REQUIRED, IT SHALL BE DONE ON AN AREA STABILIZED WITH CRUSHED STONE THAT DRAINS INTO AN APPROVED SEDIMENT TRAP OR SEDIMENT BASIN, AS SHOWN ABOVE.
  - DRIVE ENTRANCES ONTO RESIDENTIAL LOTS WILL NOT BE REQUIRED TO HAVE THE SEDIMENT BARRIER SHOWN, BUT WHEEL WASHING MAY BE REQUIRED IF STABILIZED ENTRANCE IS NOT SUFFICIENT TO KEEP MUD FROM BEING TRACKED ONTO ADJACENT STREET. ENTRANCE SHALL EXTEND FROM BACK OF CURB TO DWELLING.



SOIL EROSION BMPs  
**BACK OF CURB PROTECTION,  
CURB INLET PROTECTION  
AND  
CONSTRUCTION ENTRANCE**

JIM ARMOUR, P.E.  
CITY ENGINEER

PROJECT NUMBER 468-84157 OCA NO. 751431

DATE  
Mar 07

Sheet 22 of 26