

- GEO-RIDGE PERMEABLE BERM NOTES**
1. Overlap Geo-ridge Berm sections and apron material by 150 mm.
  2. Use M-Pins supplied by manufacturer to secure Geo-ridge Berm sections.
  3. Use as many Geo-ridge Berm sections as necessary to insure water does not flow around end of ditch check.
  4. Wire Staples shall be 150 mm long by 25 mm wide, minimum.
  5. Use silt fence material as the apron to prevent scour above and below the ditch check.

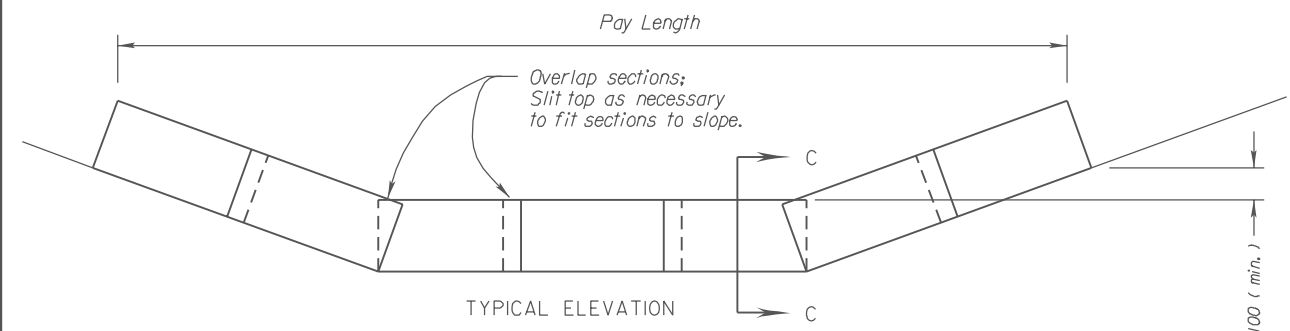

**GEO-RIDGE PERMEABLE BERM DITCH CHECK**  
NO SCALE

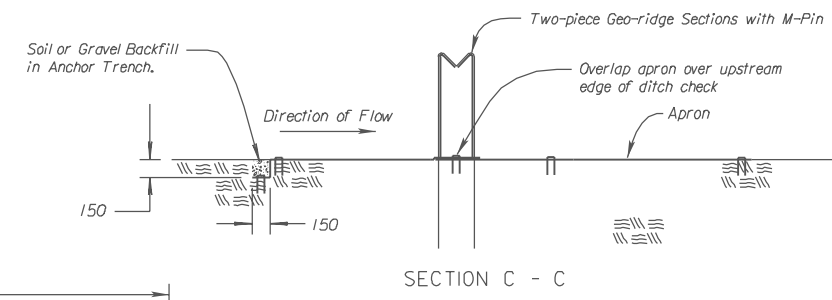
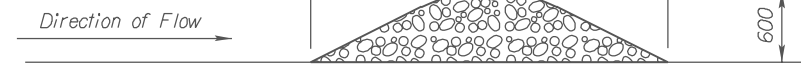

- ROCK DITCH CHECK NOTES:**
1. Rock shall be clean aggregate, D50 = 150 mm.
  2. Place rock in such manner that water will flow over ditch check, not around ditch check.
  3. Do not use rock ditch checks in clear zone.

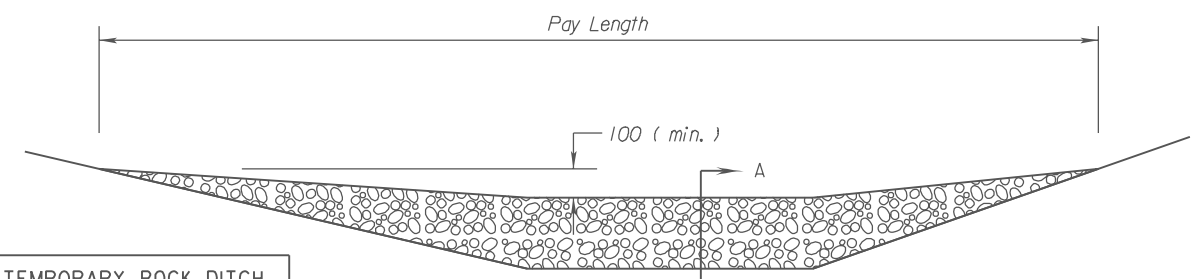

**ROCK DITCH CHECK**  
NO SCALE

**TEMPORARY ROCK DITCH CHECK SPACING**

DITCH @ SLOPE (%)	SPACING INTERVAL (METERS)
5.0	18
6.0	15
7.0	13
8.0	11
9.0	10
10.0	9

NOTE: Use this spacing only for Rock Ditch Checks.

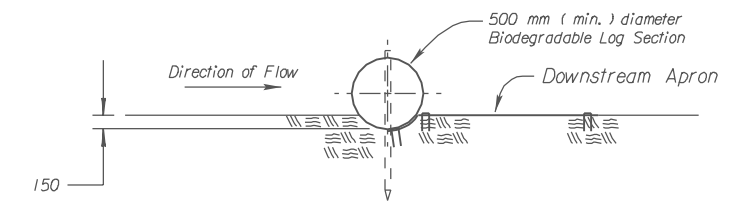
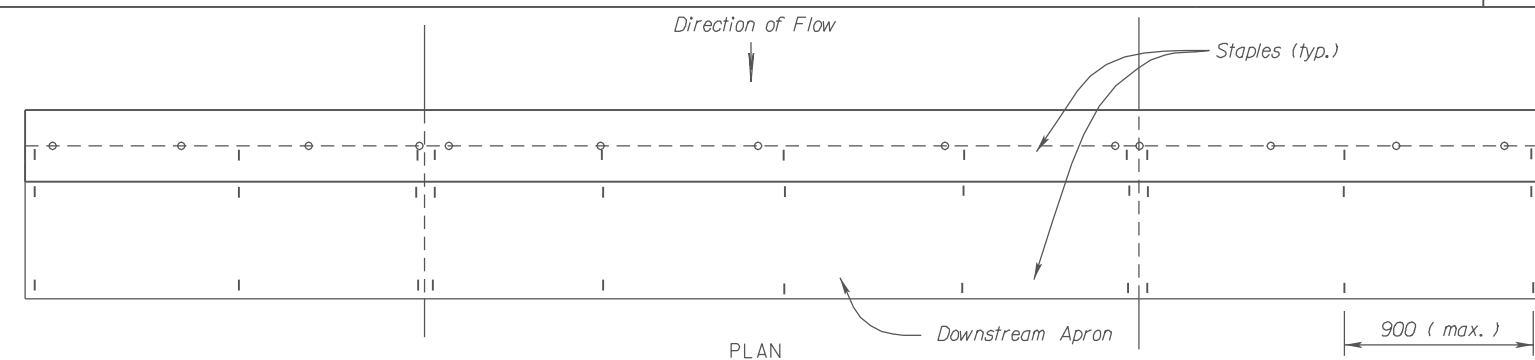

- BIODEGRADABLE LOG DIKE NOTES**
1. Place biodegradable logs tightly together, with apron material overlapping end-to-end by 150 mm.
  2. Wire staples shall be 150 mm long by 25 mm wide, minimum.
  3. Use as many biodegradable log sections as necessary to insure water does not flow around end of ditch check.
  4. Wood stakes shall be 50 mm x 50 mm (nom.) x 1 200 mm (min.) long.
  5. Use silt fence material as the downstream apron to prevent scour below the ditch check.

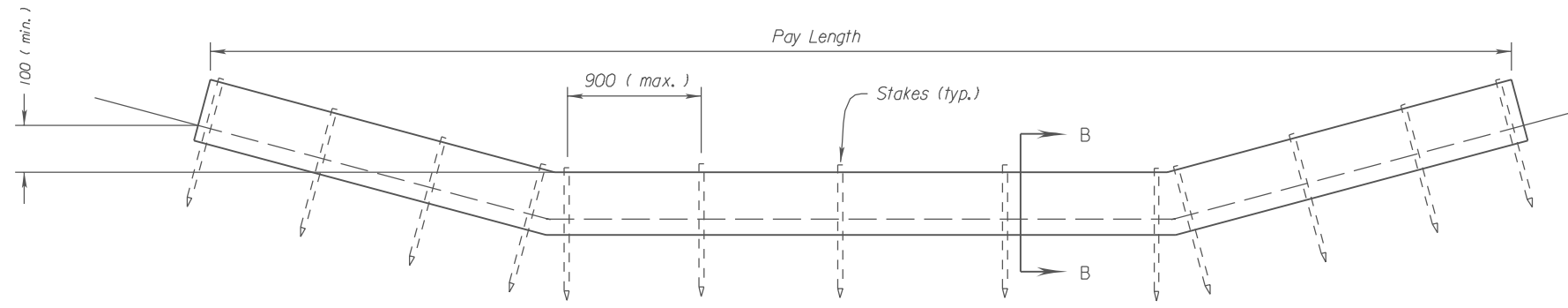

**BIODEGRADABLE LOG DITCH CHECK**  
NO SCALE

3					
2					
1					
NO.	DATE	REVISIONS	BY	APP'D	
<b>KANSAS DEPARTMENT OF TRANSPORTATION</b> <b>TEMPORARY EROSION AND POLLUTION CONTROL</b> <b>ROCK DITCH CHECKS</b> <b>BIODEGRADABLE LOG DITCH CHECKS</b> <b>GEO-RIDGE PERMEABLE BERM DITCH CHECKS</b> <b>LA852G SI</b>					
F.H.W.A. APPROVAL	5/20/99	APP'D	Richard D. Ross		
DESIGNED	WCL	QUANTITIES	TRACED	WCL	
DESIGN CK.	RDR	DETAIL CK.	RDR	QUAN. CK.	TRACED CK. RDR

Drawn By : examples  
 DGN File : g:\CIVIL\98169\05693\06\N0852.dgn  
 Plotted : 7/27/2006