

GENERAL NOTES

STATE	PROJECT NO.	YEAR	SHEET NO.	SHEETS
KANSAS	87 N-0235-01	2006	95	120

1. MAINTENANCE:

THE CONTRACTOR SHALL MAINTAIN ALL SIGNS AND DEVICES IN AN UPRIGHT POSITION. THE CONTRACTOR SHALL CLEAN OR REPLACE ANY DAMAGED OR ILLEGIBLE SIGN OR DEVICE AS DIRECTED BY THE ENGINEER.

2. EXISTING SIGNS:

IF EXISTING SIGNS THAT ARE TO REMAIN (WHETHER DENOTED ON THE PLANS OR NOT) INTERFERE WITH CONSTRUCTION WORK, THE CONTRACTOR SHALL REMOVE, STORE, AND RESET THE SIGNS. THIS SHALL BE SUBSIDIARY TO OTHER TRAFFIC CONTROL BID ITEMS. SIGNING DAMAGED BY THE CONTRACTOR SHALL BE REPLACED AT THE CONTRACTOR'S EXPENSE.

3. CONFLICTING SIGNS AND SIGNS NOT IN USE:

SIGNS THAT ARE IN CONFLICT WITH THE TRAFFIC CONTROL PLAN OR DO NOT APPLY TO THE TRAFFIC OPERATIONS SHALL BE IMMEDIATELY REMOVED, TURNED SO NOT VISIBLE TO TRAFFIC FROM ANY DIRECTION, OR COMPLETELY COVERED WITH ADEQUATE OPAQUE WATERPROOF MATERIAL. TAPE SHALL NOT BE APPLIED TO THE FACE OF THE SIGN.

4. TEMPORARY AND POST MOUNTED SIGNS:

TRAFFIC CONTROL SIGNS THAT ARE ANTICIPATED TO REMAIN IN PLACE FOR 3 DAYS OR LESS ARE CONSIDERED "TEMPORARY." TEMPORARY SIGNS SHALL BE MOUNTED ON AN APPROVED SUPPORT AT A MINIMUM HEIGHT OF 12". TRAFFIC CONTROL SIGNS IN PLACE FOR OVER 3 DAYS ARE REQUIRED TO BE MOUNTED ON APPROVED POSTS. A MINIMUM OF 42" OF THE APPROVED POST MUST BE BELOW THE GROUND SURFACE WITH ADEQUATE BACKFILL AND COMPACTION. ALL POSTS SHALL EXTEND NO GREATER THAN 6" ABOVE THE SIGN.

5. SHEETING:

ALL ORANGE SIGNS SHALL BE RETROREFLECTORIZED WITH FLOURESCENT ORANGE PRISMATIC GRADE SHEETING. ALL OTHER SIGNS SHALL BE RETROREFLECTORIZED WITH TYPE III HIGH PERFORMANCE SHEETING OF STANDARD COLORS.

6. ROLL-UP SIGNS:

ROLL-UP SIGNS MAY BE USED FOR TEMPORARY WARNING SIGNS. THEY MUST BE FLOURESCENT ORANGE PRISMATIC GRADE RETROREFLECTIVE SIGNS OF OPAQUE MATERIAL. MESH SIGNS ARE NOT ALLOWED.

7. SIGNS INVOLVING SPEEDS:

THE R2-5E (REDUCED SPEED  AHEAD) SHOULD BE USED ONLY IF THE ENGINEER DETERMINES THAT A REDUCED SPEED IS REQUIRED ON THE PROJECT.

THE M4-20 (WORK ZONE) PLAQUE SHALL BE PLACED ABOVE ALL SPEED LIMIT SIGNS, (R2-1), EXISTING AND TEMPORARY.

FOR SPEEDS OF 30 MPH OR LESS, THE W1-1(TURN) OR W1-3(REVERSE TURN) SHOULD BE USED. FOR SPEEDS OF 35 MPH OR MORE, THE W1-2(CURVE) OR W1-4(REVERSE CURVE) SHOULD BE USED. THE W13-1(MPH) IS TO BE ELIMINATED IF THE ADVISORY SPEED IS WITHIN 5 MPH OF THE SPEED LIMIT.

8. SIGNS CONTROLLING WORK AREA:

THE G20-2A(END ROAD WORK) SHOULD BE PLACED 500' FROM THE END OF THE ACTUAL WORK AREA, NOT NECESSARILY AT THE EXTREME LIMITS OF THE PROJECT.

WHERE TWO WORK AREAS ARE LESS THAN 1 MILE APART IN RURAL AREAS OR 1/4 MILE APART IN URBAN AREAS, THE G20-2A(END ROAD WORK) FOR THE FIRST WORK AREA AND THE W20-1(ROAD WORK) FOR THE SECOND WORK AREA SHOULD BE ELIMINATED.

9. WARNING LIGHTS ON SIGNS:

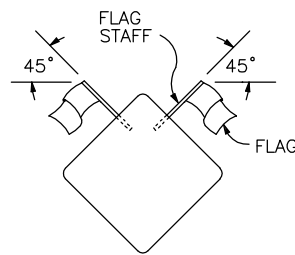

TYPE B HIGH INTENSITY LIGHTS SHALL BE USED ON ALL CONSTRUCTION WARNING ACTION SIGNS. ON ALL OTHER CONSTRUCTION WARNING SIGNS, TYPE B HIGH INTENSITY LIGHTS ARE TO BE USED AS DIRECTED BY THE ENGINEER.

THEY SHALL NOT BE INSTALLED ON SIGNS MOUNTED LESS THAN 5' HIGH ON TEMPORARY SUPPORTS. THEY SHALL BE MAINTAINED SO THAT THEY ARE VISIBLE ON A SUNNY DAY FROM A DISTANCE OF 1000' WHEN VIEWED WITHOUT THE SUN DIRECTLY ON OR BEHIND THE DEVICE. IF A TYPE B LIGHT HAS A SEPARATE BATTERY CASE, THE BATTERY CASE SHALL BE MOUNTED NO HIGHER THAN 12" ABOVE THE GROUND AND MOUNTED BEHIND THE SIGN POST. FOR A TYPE B LIGHT, WHERE THE LENS IS MOUNTED TO THE TOP OF THE BATTERY CASE, THE TYPE B LIGHT (LENS AND BATTERY) SHALL BE MOUNTED AT THE TOP OF THE SIGN.



TWO (2) 18" x 18" FLOURESCENT RED-ORANGE FLAGS ARE TO BE ATTACHED IN THE POSITION SHOWN ON THE W20-2(DETOUR), W1-1(TURN), W1-2(CURVE), W1-3(REVERSE TURN), W1-4(REVERSE CURVE), W3-3(SIGNAL AHEAD), W4-2(LANE REDUCTION), W20-4(ONE LANE ROAD), W20-5(LANE CLOSED), W20-7A(FLAGGER), AND W20-7B (BE PREPARED TO STOP) SIGNS AND ANY OTHER ACTION SIGNS AS SHOWN ON THE PLANS OR DIRECTED BY THE ENGINEER. THE FLAGS AND STAFFS ARE TO BE ATTACHED IN SUCH A MANNER THAT THE SIGN WILL NOT BE OBTSCURED. THE FLAGS MAY BE EITHER A CLOTH OR VINYL MATERIAL. THE FLAGS SHALL BE SUBSIDIARY TO THE CONSTRUCTION SIGN BID ITEMS.

SIGN LAYOUT INFORMATION

	7" C 7" C 7" C		STD. SIZE 4" C 4" C 10" E 4" D	EXPWY/FREEWAY 8" C 8" C 16" E 8" D
W20-7b 48"x 48" (BLACK/ORANGE)		R2-5e (BLACK/WHITE)	24"x 36"	48"x 72"
			3" C 24"x 6"	6" C 48"x 12"
		M4-20 (BLACK/ORANGE)		

NOTE:  
TEXT DIMENSIONS ARE IN INCHES.  
BORDER IS BLACK NON-REFLECTIVE.

ADVANCE WARNING SIGN SPACING (IN FEET):

	A	B	C
URBAN (40 MPH OR LOWER)	100	100	100
URBAN (45 MPH OR HIGHER)	350	350	350
RURAL	500	500	500
EXPRESSWAY/FREEWAY	1000	1500	2640

THE SPACING BETWEEN ANY SIGNS MAY BE ADJUSTED AS APPROVED BY THE ENGINEER IN ORDER TO MAXIMIZE VISIBILITY.

THE SPACING BETWEEN SIGNS SHALL BE NO LESS THAN 100', UNLESS DIRECTED BY THE ENGINEER.

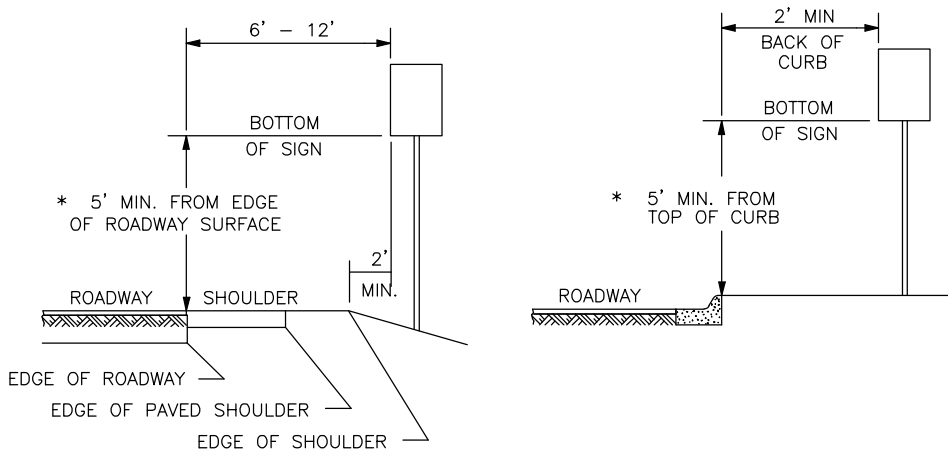

- \* NOTE:
- A. IN BUSINESS, COMMERCIAL, AND RESIDENTIAL DISTRICTS, THE DISTANCE BETWEEN THE BOTTOM OF THE SIGN AND THE TOP OF THE NEAR EDGE OF THE TRAVEL WAY SHALL BE AT LEAST 7'.
  - B. LARGE SIGNS HAVING AN AREA EXCEEDING 54 SQUARE FEET THAT ARE INSTALLED ON MULTIPLE BREAKAWAY POSTS SHALL BE MOUNTED A MINIMUM OF 7' ABOVE THE GROUND.
  - C. THE HEIGHT TO THE BOTTOM OF THE SECONDARY SIGN MOUNTED BELOW ANOTHER SIGN MAY BE 1' LESS THAN THE APPROPRIATE HEIGHT SPECIFIED ABOVE.

HEIGHT AND LATERAL DIMENSIONS FOR POST MOUNTED SIGNS (SIGNS LEFT IN PLACE OVER 3 DAYS)

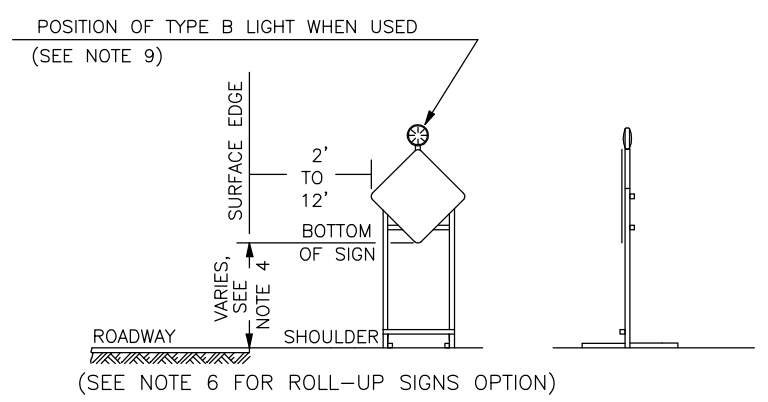

HEIGHT AND LATERAL DIMENSIONS FOR SIGNS MOUNTED ON SKIDS OR OTHER PORTABLE SUPPORTS

C:\p1\040221\040221.dwg 2/16/2005 4:09:29 PM EST

KANSAS DEPARTMENT OF TRANSPORTATION

TRAFFIC CONTROL SIGNS

PROJECT NO. 87 N-0235-01 SEDGWICK CO.

**M K E C ENGINEERING CONSULTANTS, INC.**  
WICHITA, KANSAS

DESIGNED BY: JRA	CHECKED BY: JRA
DRAWN BY: WNJ	DATE: JULY 2004 SHEET 95 OF 120