

11+08.72

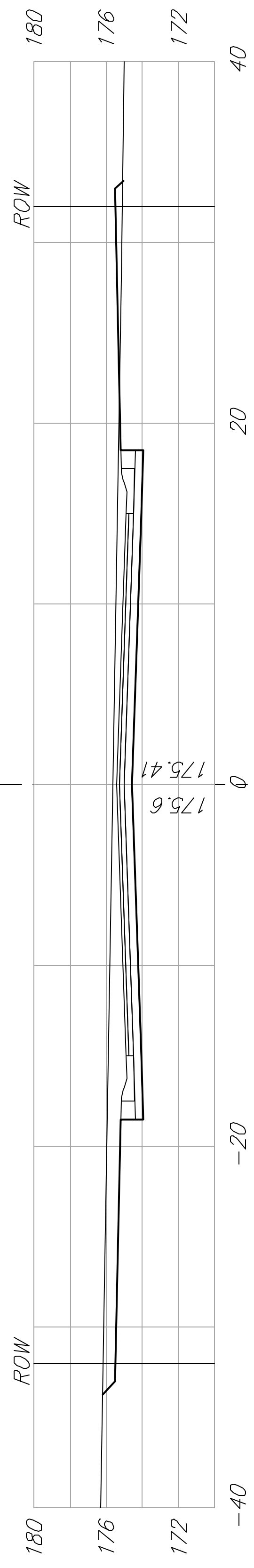

10+50

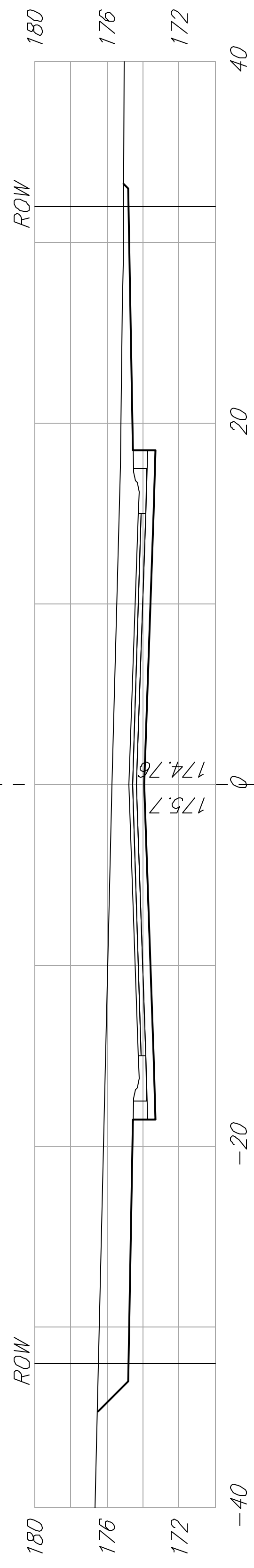

10+27.93



10+00

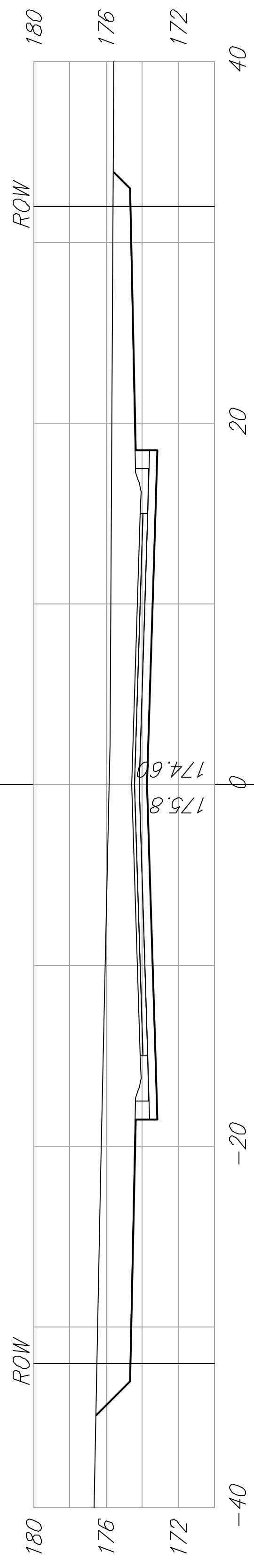

9+78.37

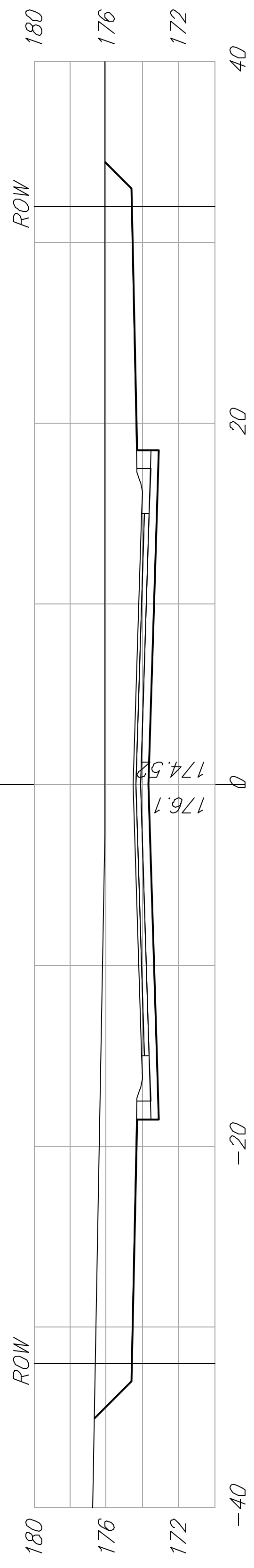

9+50

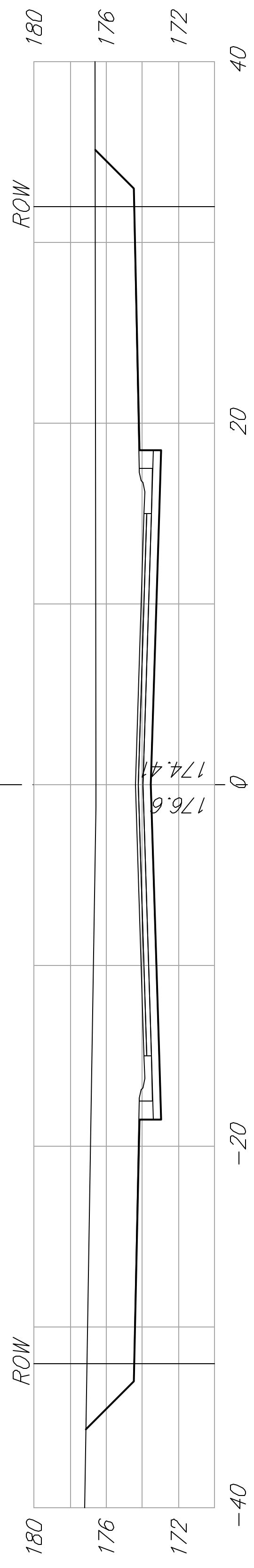

9+00

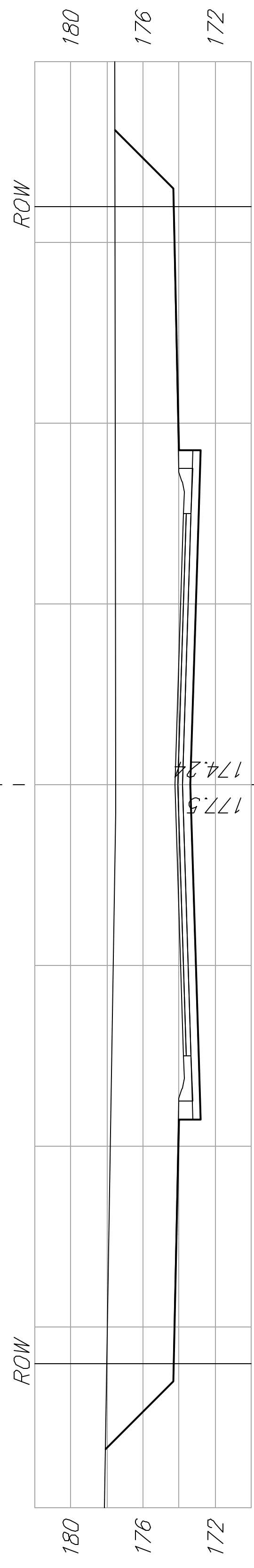

8+58.37

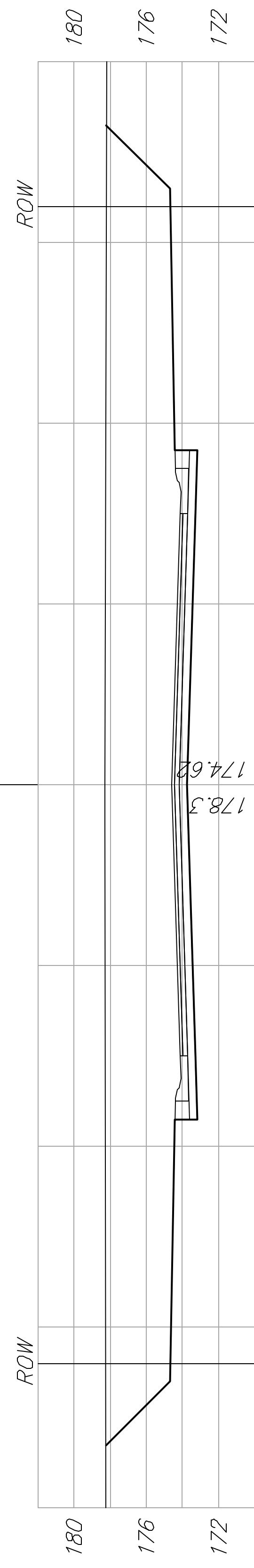

AUBURN HILLS