

EXPANSION JOINT

NOTE: Extra Thickness to be Subsidiary to Price of Square Yards Pavement

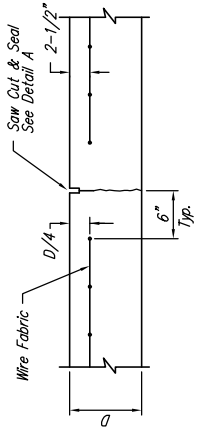

CONTRACTION JOINT DETAIL (C.J.)

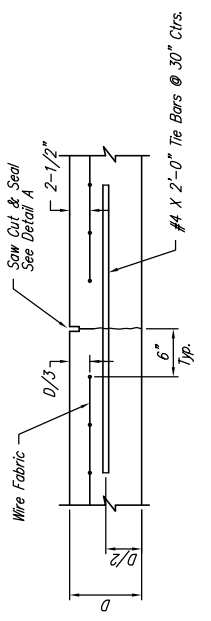

LONGITUDINAL JOINT DETAIL (L.J.)

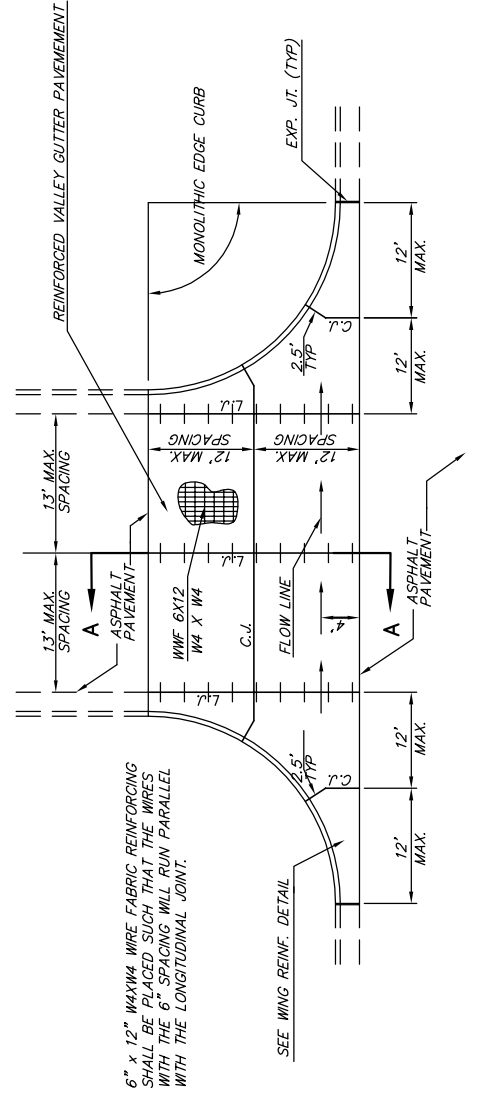

PLAN

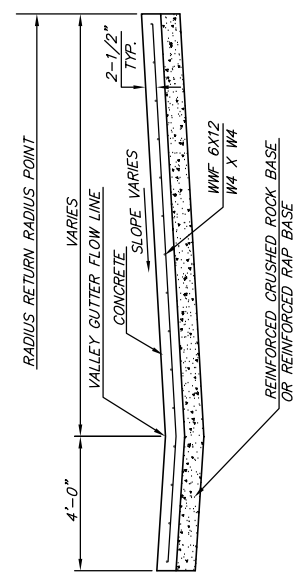

SECTION A-A

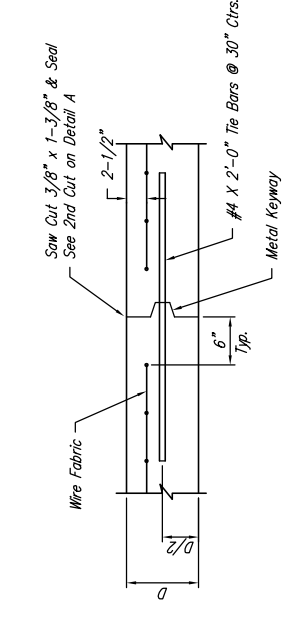

OPTIONAL LONGITUDINAL JOINT DETAIL (L.J.)

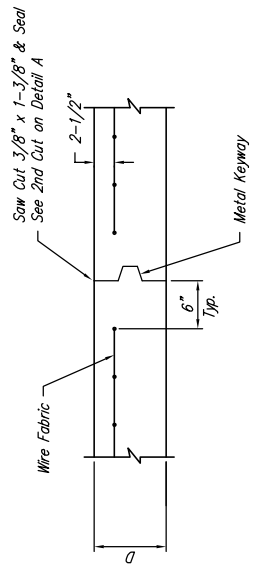

OPTIONAL CONTRACTION JOINT

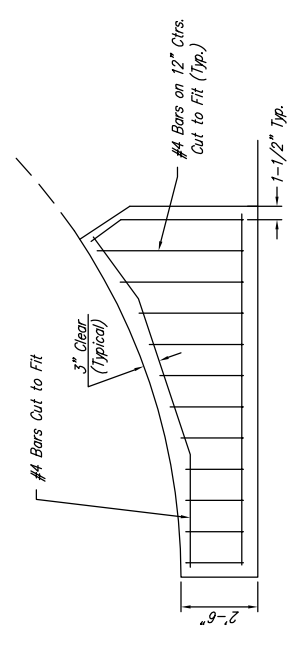

WING REINFORCING DETAIL

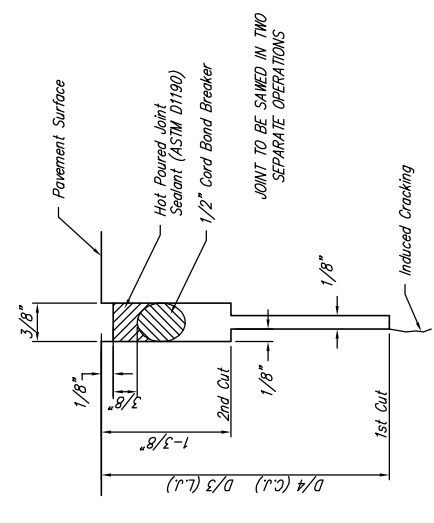

SAW JOINT DETAIL

REINFORCED VALLEY GUTTER DETAIL

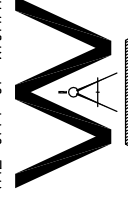
THE CITY OF WICHITA		VALLEY GUTTER DETAILS	
		JIM ARMOUR, P.E.-ACTING CITY ENGINEER PROJECT NUMBER 472-83937 OCA NUMBER 765844 DATE JUL 03 SHEET 4 OF 18	
CITY ENGINEER'S OFFICE CIVIL ENGINEER FOR WICHITA, KANSAS 67202 1415 NORTH MAIN STREET WICHITA, KANSAS 67202 (316) 268-1114 FAX			