

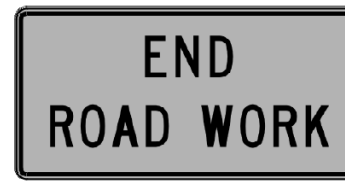







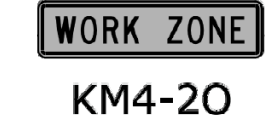

SIGN LAYOUT INFORMATION

 <p>END ROAD WORK KG20-2</p>	<p>STD. SIZE EXPWY/FREEWAY 6" C 48"x 24"</p>	 <p>GROOVED PAVEMENT W8-15</p>	<p>STD. SIZE EXPWY/FREEWAY 8" D 48"x 48"</p>
 <p>WAIT FOR PILOT CAR KG20-5</p>	<p>STD. SIZE EXPWY/FREEWAY 6" C 48"x 24"</p>	 <p>LOOSE GRAVEL W8-7</p>	<p>STD. SIZE EXPWY/FREEWAY 8" D 48"x 48"</p>
 <p>WORK ZONE KM4-20</p>	<p>STD. SIZE EXPWY/FREEWAY 3" C 6" C 24"x 6" 48"x 12"</p>	 <p>MOTORCYCLE W8-15p</p>	<p>STD. SIZE EXPWY/FREEWAY 30"x 24"</p>
 <p>NEXT X MILES W7-3a</p>	<p>Mileage to be determined by the engineer.</p>	 <p>UNEVEN LANES W8-11</p>	<p>STD. SIZE EXPWY/FREEWAY 8" D 48"x 48"</p>
 <p>SHOULDER DROP-OFF W8-17</p>	<p>STD. SIZE EXPWY/FREEWAY 48"x 48"</p>	 <p>UNEVEN LANES W8-11</p>	<p>STD. SIZE EXPWY/FREEWAY 8" D 48"x 48"</p>
 <p>SHOULDER DROP-OFF W8-17P (OPTIONAL)</p>	<p>STD. SIZE EXPWY/FREEWAY 30"x 24"</p>		
 <p>NB US-75 CLOSED FOLLOW DETOUR SP-01 (SPECIAL SIGN)</p>	<p>STD. SIZE EXPWY/FREEWAY 6" C 10" D</p>		
 <p>US-75 CLOSED NORTH OF Topeka FOLLOW DETOUR SP-02 (SPECIAL SIGN)</p>	<p>STD. SIZE UPPERCASE: 6" C LOWER CASE: 4.5" C</p>	<p>EXPWY/FREEWAY UPPERCASE: 10" D LOWER CASE: 8" D</p>	

ALL CITY NAMES AND STREET NAMES ON SPECIAL SIGNS AND DESTINATION SIGNS MUST HAVE UPPER AND LOWER CASE LETTERS.

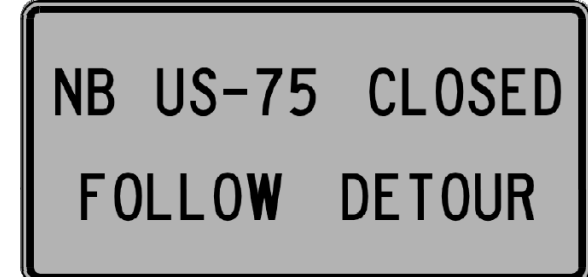
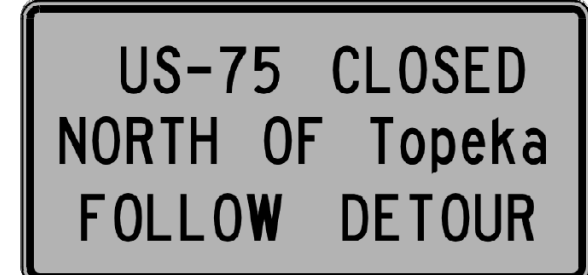
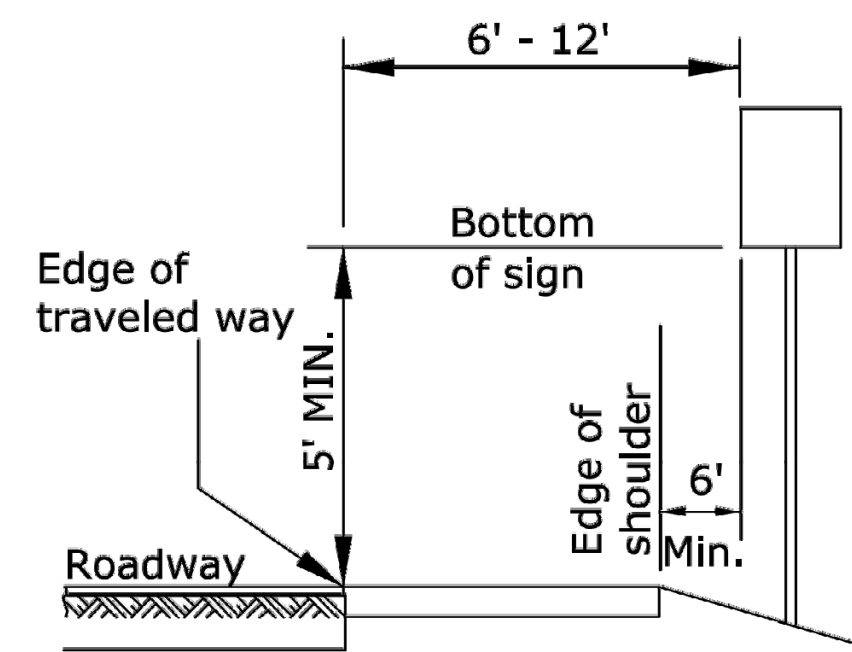

Rural

- 1) Ground-mounted signs shall be mounted at a minimum height of 5' measured from the bottom of sign to the near edge of the pavement.
- 2) Large signs having an area exceeding 50 square feet installed on multiple breakaway posts shall be mounted a minimum of 7' above the ground.
- 3) The height of the secondary sign mounted below another sign may be 4' measured from the bottom of the sign to the near edge of the pavement. Signs shall not overlap each other.

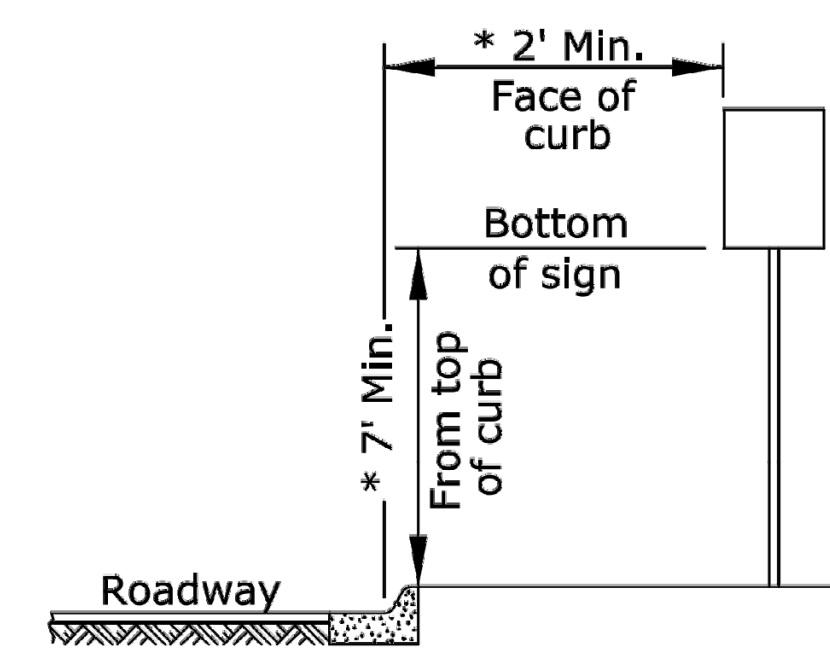

Urban

- 1) Signs shall be mounted at a minimum height of 7' measured from the bottom of sign to the near edge of the pavement.
- 2) Neither portable nor permanent sign supports should be located on sidewalks or areas designated for pedestrian or bicycle traffic.
- 3) Signs mounted lower than 7' should not project more than 4" into pedestrian facilities.
- 4) The height from of the secondary sign mounted below another sign may be 6' measured from the bottom of sign to the near edge of the pavement. Signs shall not overlap each other.
- 5) Large signs having an area exceeding 50 square feet installed on multiple breakaway posts shall be mounted a minimum of 7' above the ground.
- * 6) Pedestrian detour signing shall be a minimum of 2' measured from the top of the pedestrian pathway to the bottom of the sign and shall not protrude into the walkway nor shall it project beyond the back of curb.

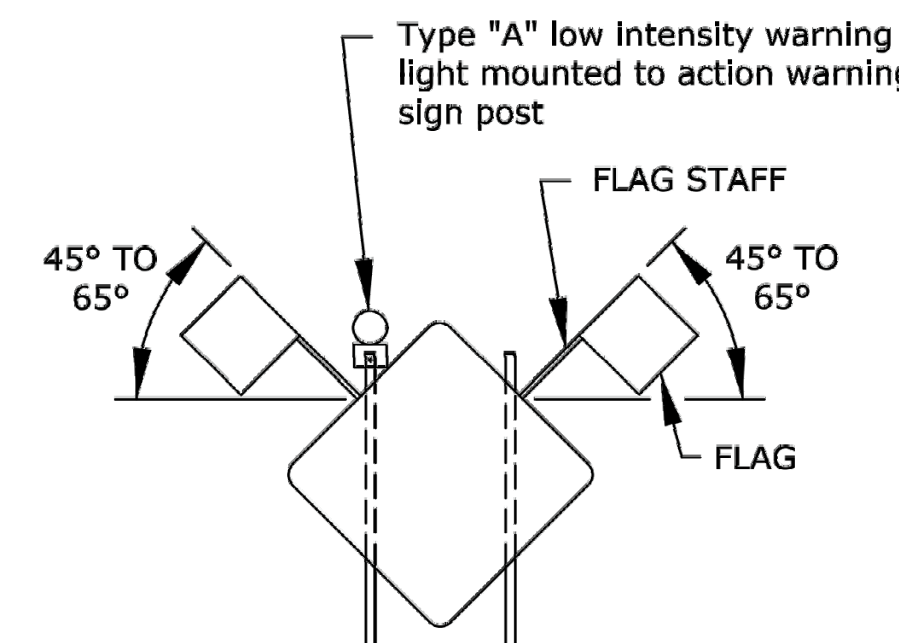

When the sign width is equal to or greater than 9', three or more wood posts may be used with a minimum of 4' between the centerline of each post. All signs less than 9' in width shall use a maximum of two wood posts.

- In the case of hitting rock when driving posts
1. Shift the sign location. Do not violate minimum sign spacing.
 2. With the engineer's approval, use acceptable alternative sign stands.

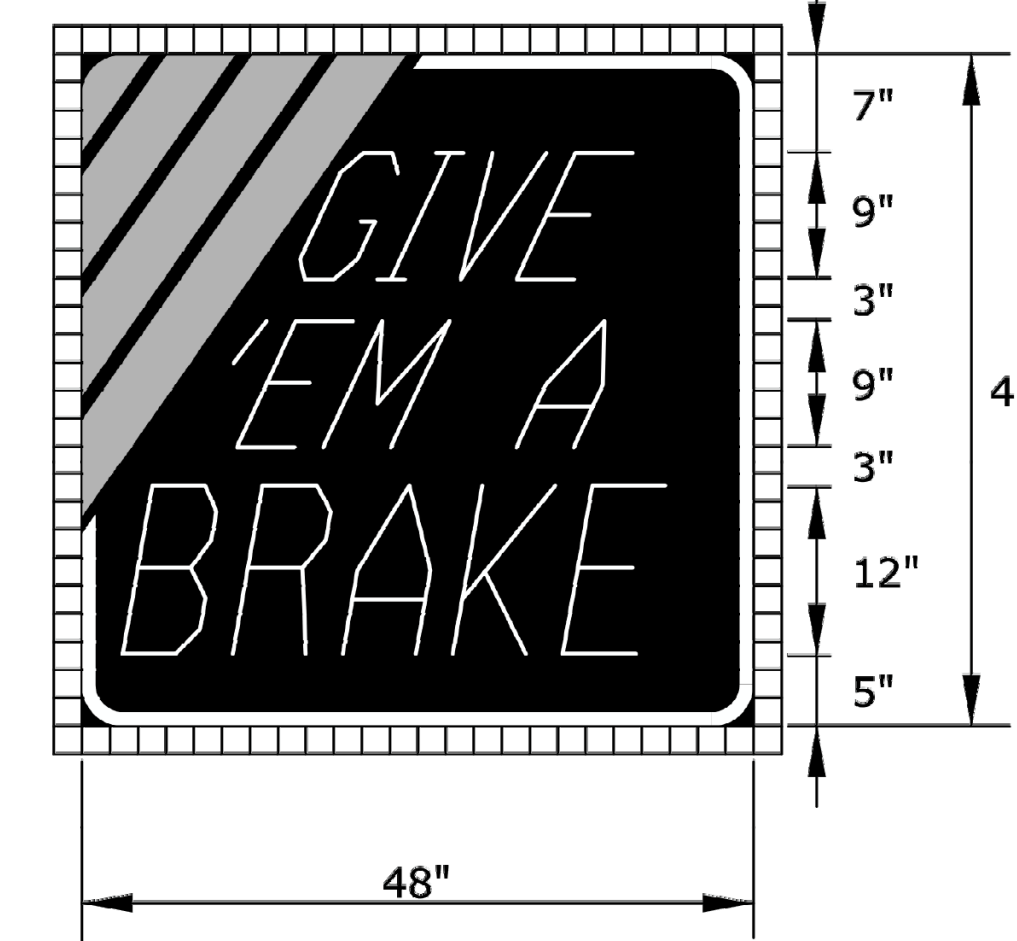

KI-104a

SIGN NUMBER	GIVE EM A BRAKE
WIDTH x HEIGHT	4'-0" x 4'-0"
BORDER WIDTH	1.0"
CORNER RADIUS	4.0"
STRIPE WIDTH	3.0"
MOUNTING	GROUND
BACKGROUND	TYPE: NON-REFLECTIVE COLOR: BLACK
LEGEND/BORDER	TYPE: REFLECTIVE COLOR: WHITE
LEGEND FONT	DUTCH 801 ROMAN SWC 25 DEGREE SLANT
STRIPES	TYPE: REFLECTIVE COLOR: ORANGE

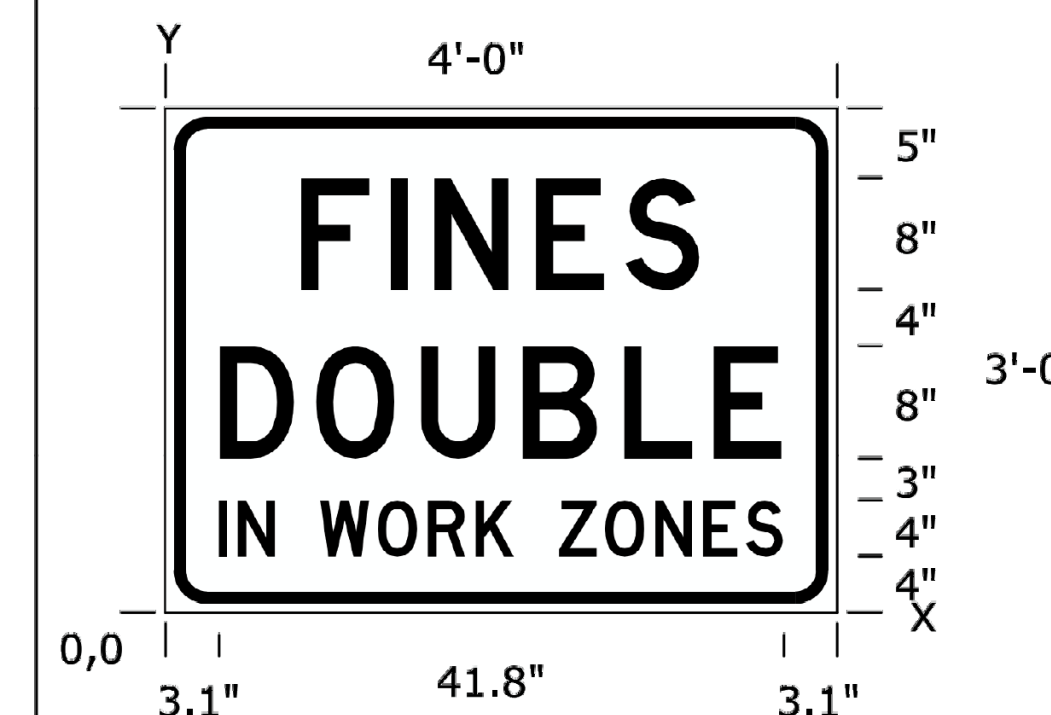

KI-105a

SIGN NUMBER	FINES DOUBLE
WIDTH x HEIGHT	4'-0" x 3'-0"
BORDER WIDTH	0.9"
CORNER RADIUS	3.0"
MOUNTING	GROUND
BACKGROUND	TYPE: REFLECTIVE COLOR: WHITE
LEGEND/BORDER	TYPE: NON-REFLECTIVE COLOR: BLACK

DIMENSIONS IN INCHES SPACINGS ARE TO START OF NEXT LETTER

Y FONT	LETTER SPACINGS											HT LEN				
23.0	F	I	N	E	S							8.0				
D	9.7	6.4	3.2	7.3	6.4	5.4	9.7					28.6				
11.0	D	O	U	B	L	E						8.0				
D	3.9	6.9	7.5	7.3	7.3	6.4	4.9	3.9				40.3				
4.0	I	N	W	O	R	K	Z	O	N	E	S	4.0				
D	3.1	1.6	2.7	3.2	4.3	3.8	3.6	2.8	3.2	3.4	3.8	3.6	3.2	2.7	3.1	41.8

Notes:

- Typically, there are two sets of informational signs installed per project: one for each direction of traffic.
- Install signs a minimum of 500' in advance of the road work ahead sign. The engineer may designate a more appropriate location if conditions dictate.
- The informational signs are not to interfere with the traffic control signs for the project.

3				
2				
1				
NO.	DATE	REVISIONS	BY	APP'D
KANSAS DEPARTMENT OF TRANSPORTATION				
TRAFFIC CONTROL SIGN INFORMATION				
TE710				
FHWA APPROVAL	06/01/15	APP'D	Kristina Pyle	
DESIGNED	R.W.B.	QUANTITIES	TRACED	
DESIGN CK.	DETAIL CK.	QUAN. CK.	TRACE CK.	