

TYPE 1
(Arterial curb)

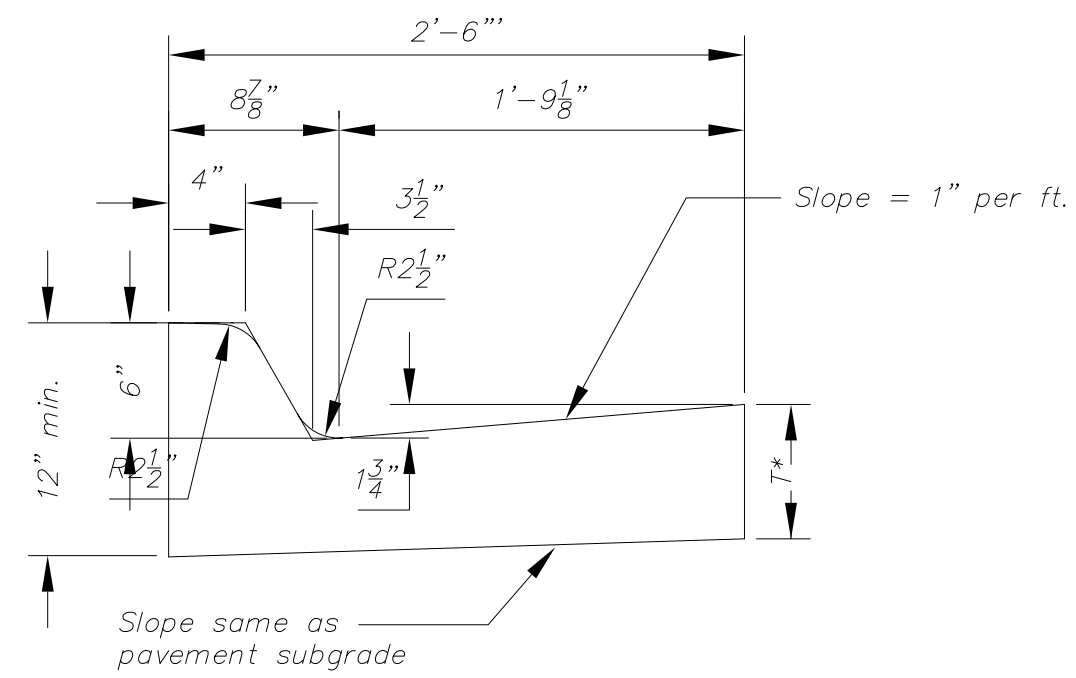

Combined Curb & Gutter (6")

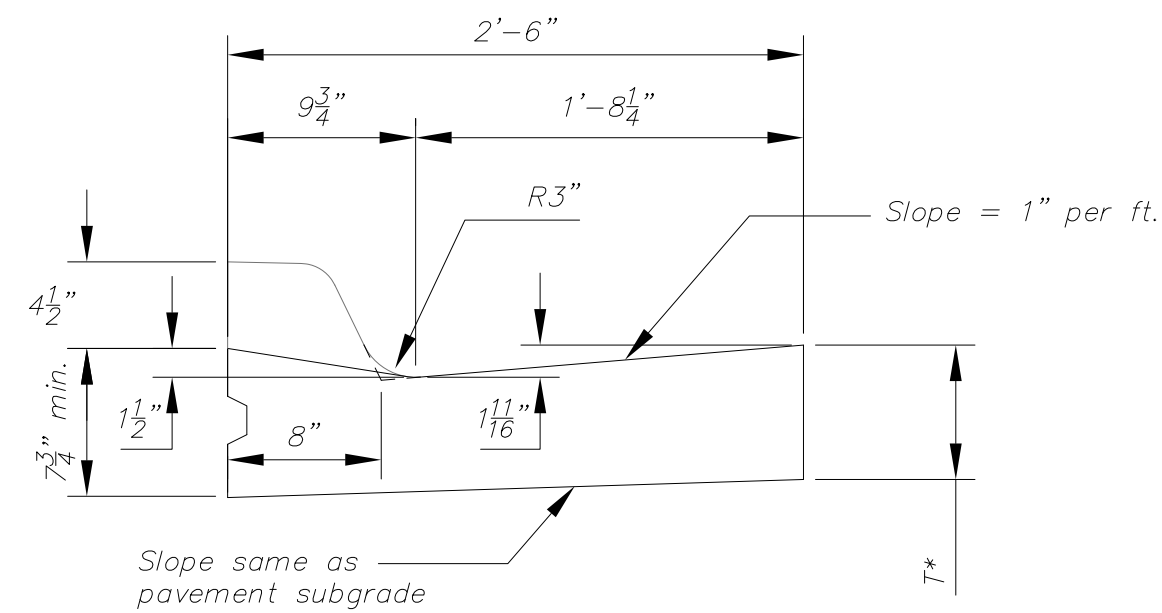

Combined Curb & Gutter (1 1/2")

TYPE 2
(Roll curb)

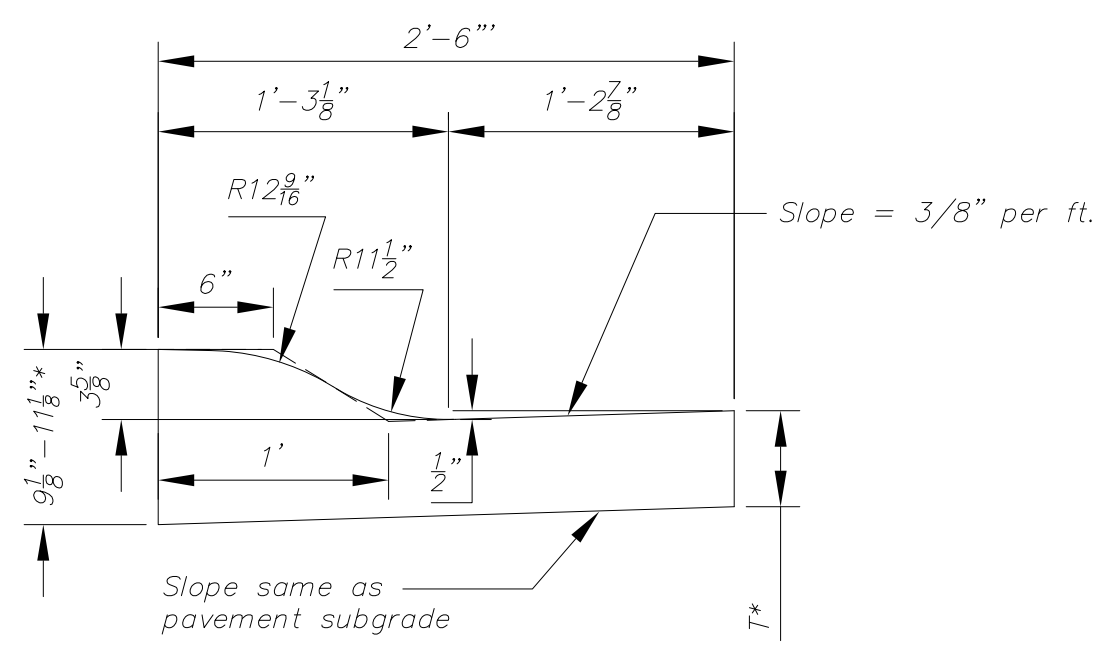

Combined Curb & Gutter (3 5/8")

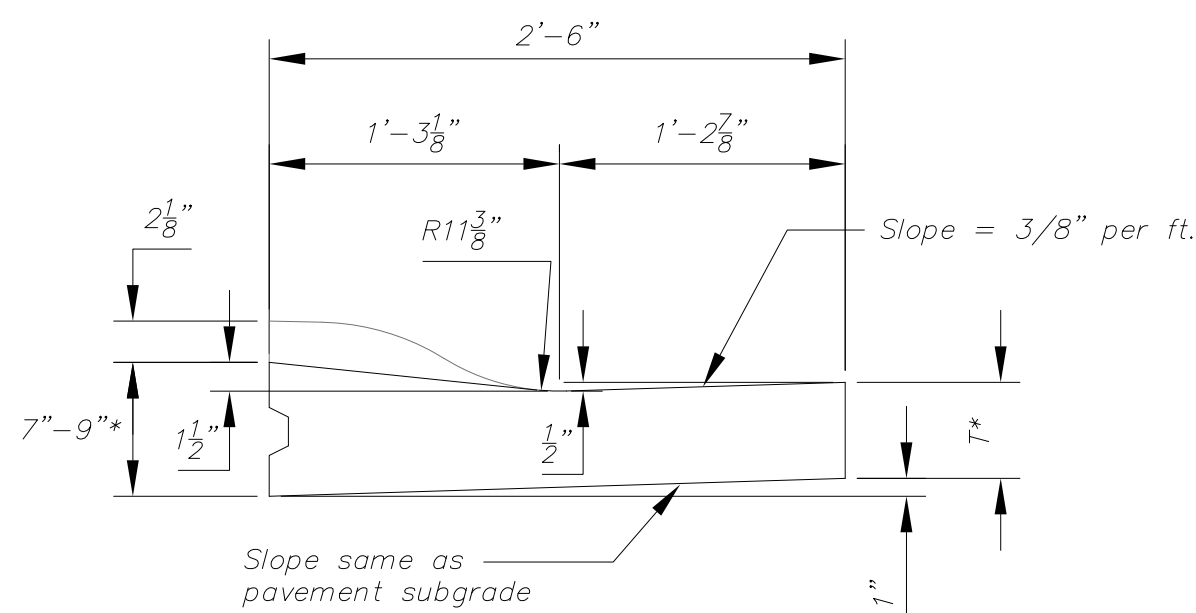

Combined Curb & Gutter (1 1/2")

TYPE 3
(Median curb)

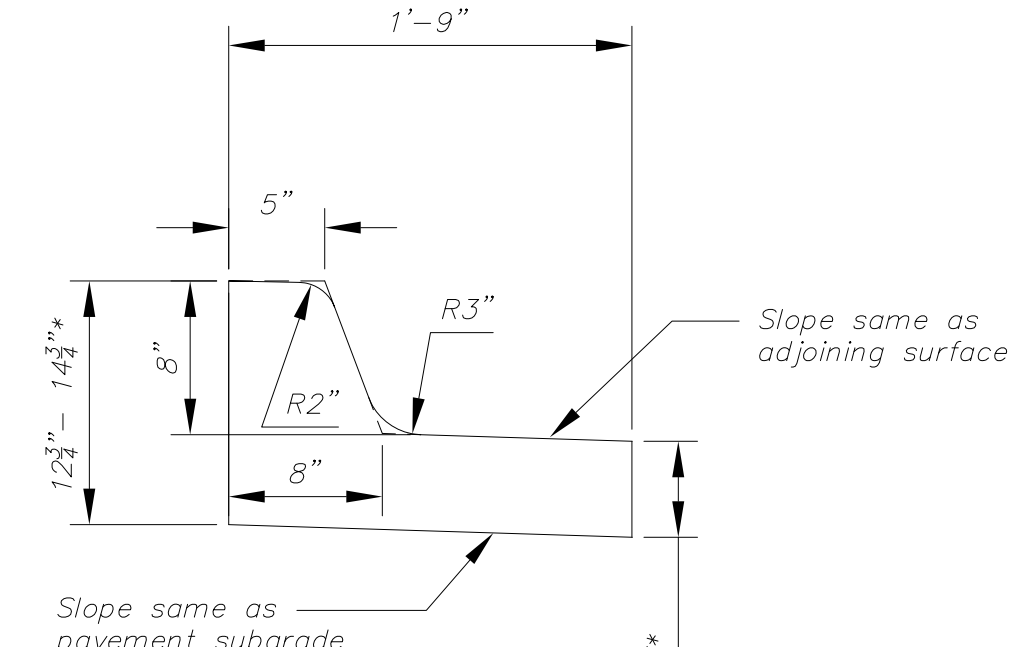

Combined Curb & Gutter (8")

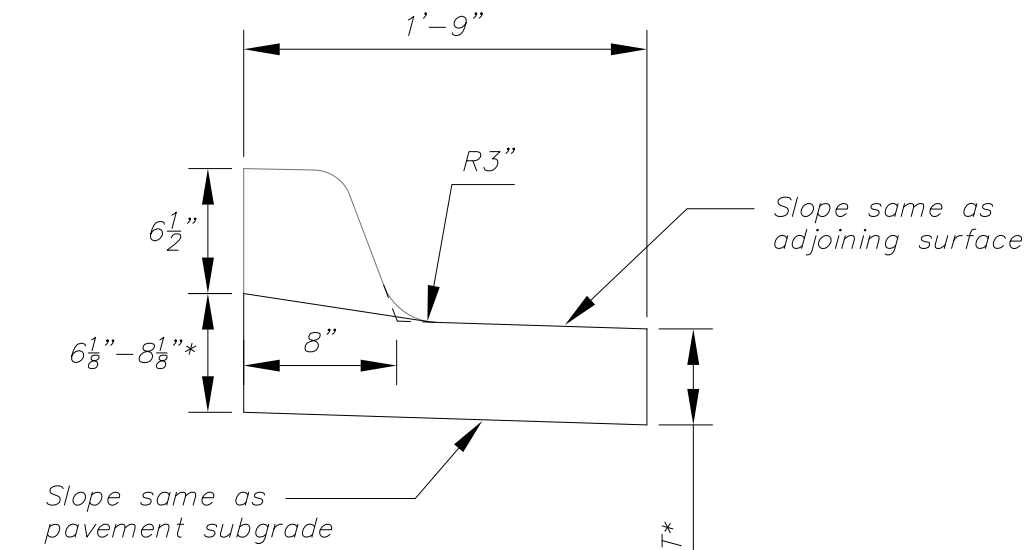

Combined Curb & Gutter (1 1/2")

TYPE 4
(Residential curb)

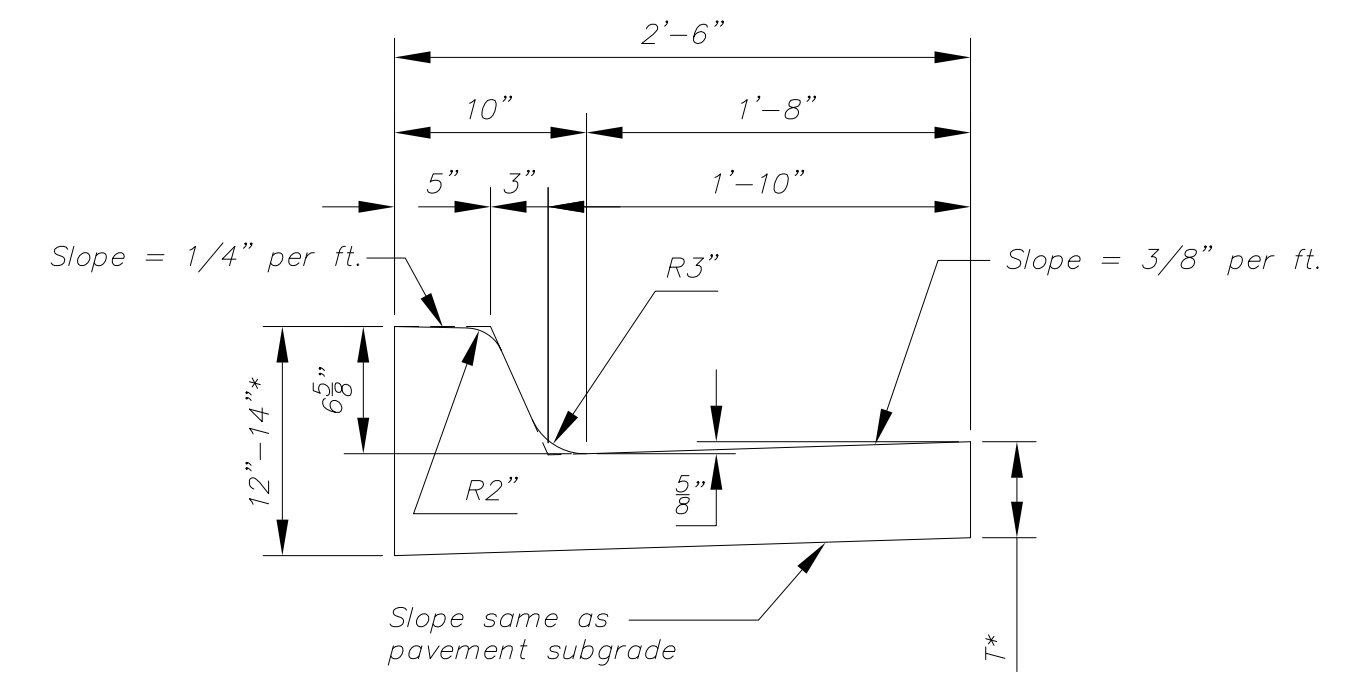

Combined Curb & Gutter (6 5/8")

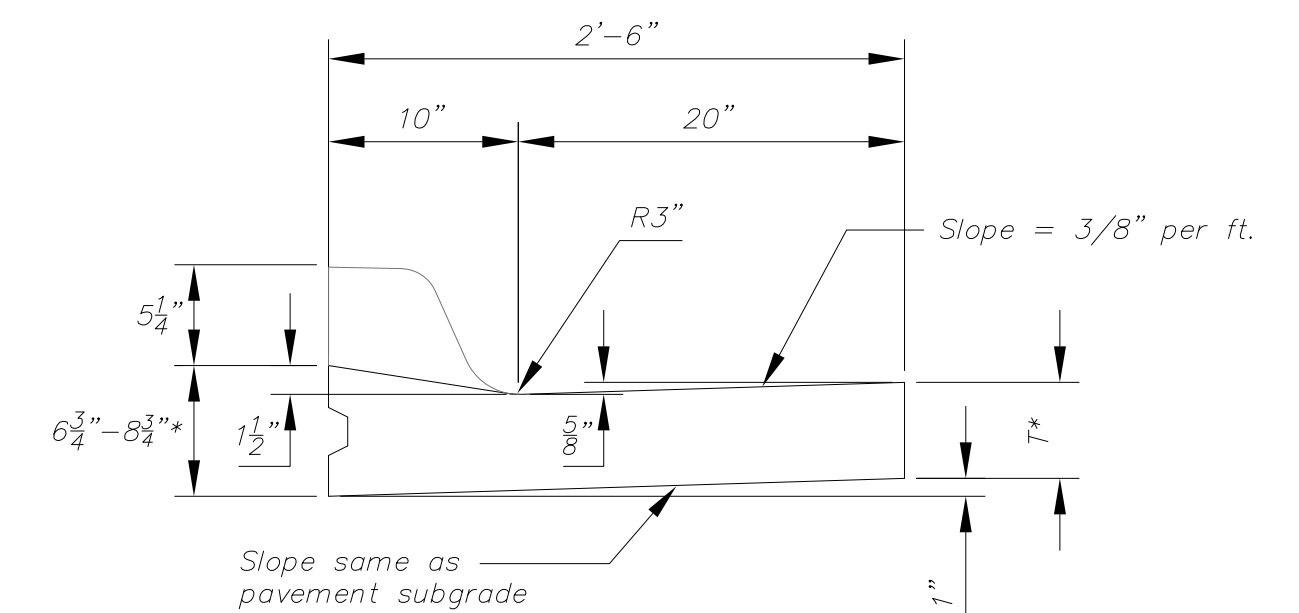

Combined Curb & Gutter (1 1/2")

T* = Thickness of curb to adjust with pavement thickness

GENERAL NOTES

- Expansion (isolation) joints shall be constructed a maximum of 300' apart and at all Pls, PCs, cul-de-sac quadrants, and ends of returns.
- Contraction joints shall be constructed a minimum of 12' apart.
- Joint sealer shall be required at all joints on arterial and industrial streets and at intersections on residential streets.

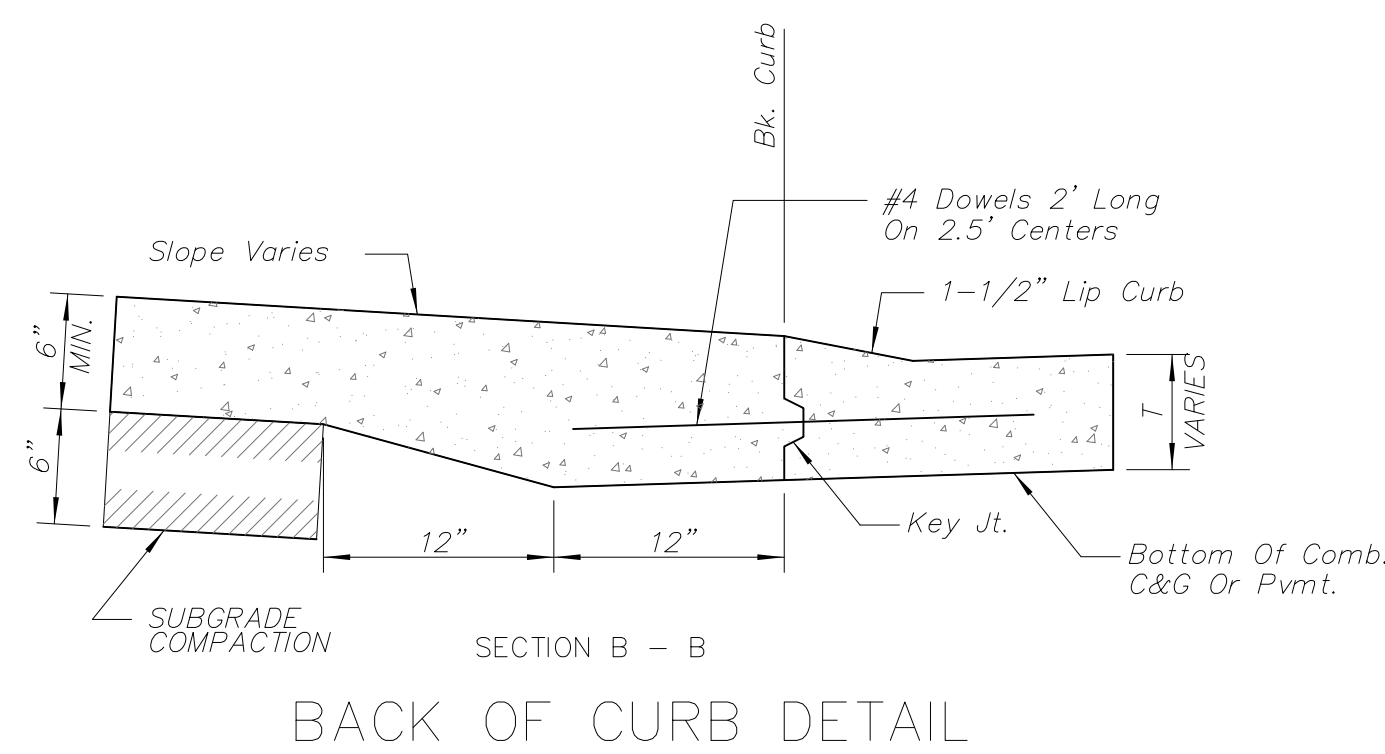

ALT. LONGITUDINAL CONSTRUCTION JOINT

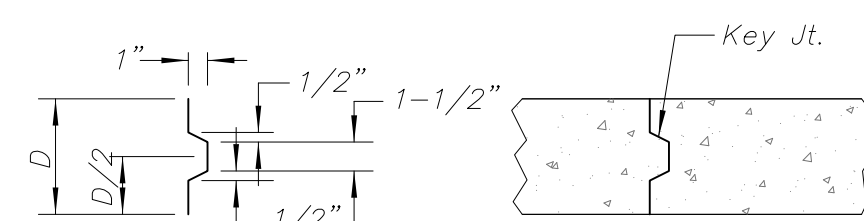

EXPANSION JOINT (E.J.)

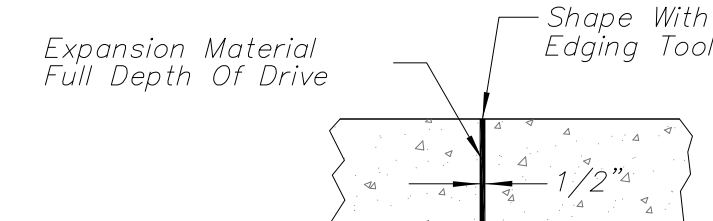

 <p>CITY OF WICHITA PUBLIC WORKS & UTILITIES ENGINEERING DIVISION</p>	<p>CURB & GUTTER DETAILS</p>		
	<p>CITY ENGINEER GARY JANZEN, P.E.</p>		
	PROJECT NUMBER	OCA NUMBER	DATE
			12/2010
CITY ENGINEER'S OFFICE CITY HALL - SEVENTH FLOOR 455 NORTH MAIN STREET WICHITA, KANSAS 67202-1620 (316) 268-4501		SHEET	3 of 16