

Combined Curb & Gutter (6")

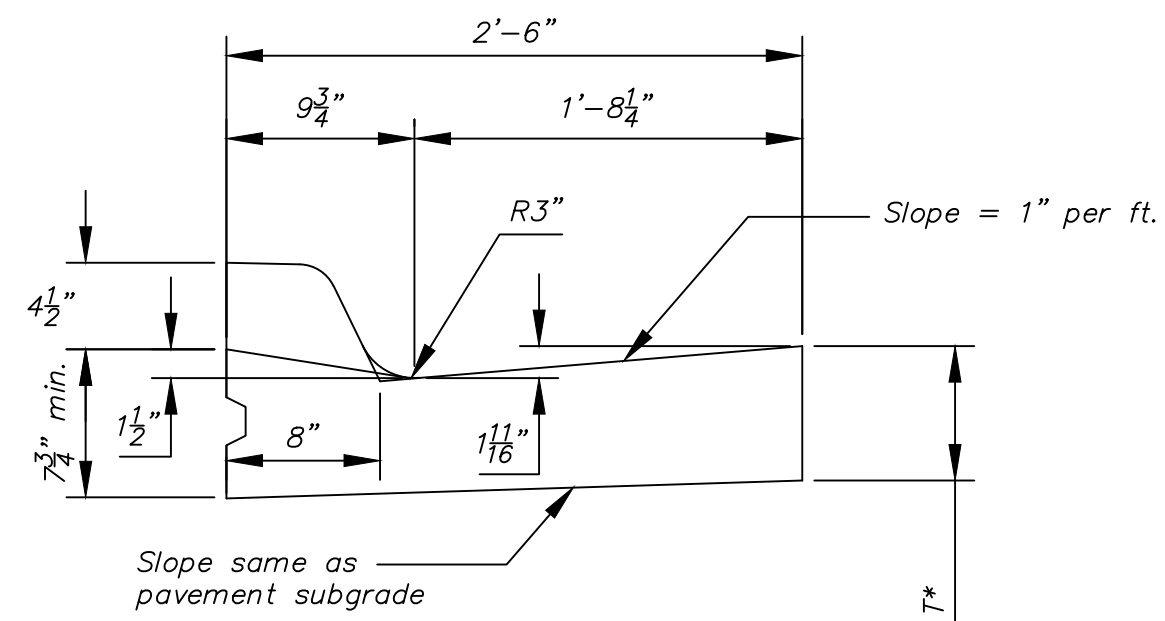

Combined Curb & Gutter (1 1/2")

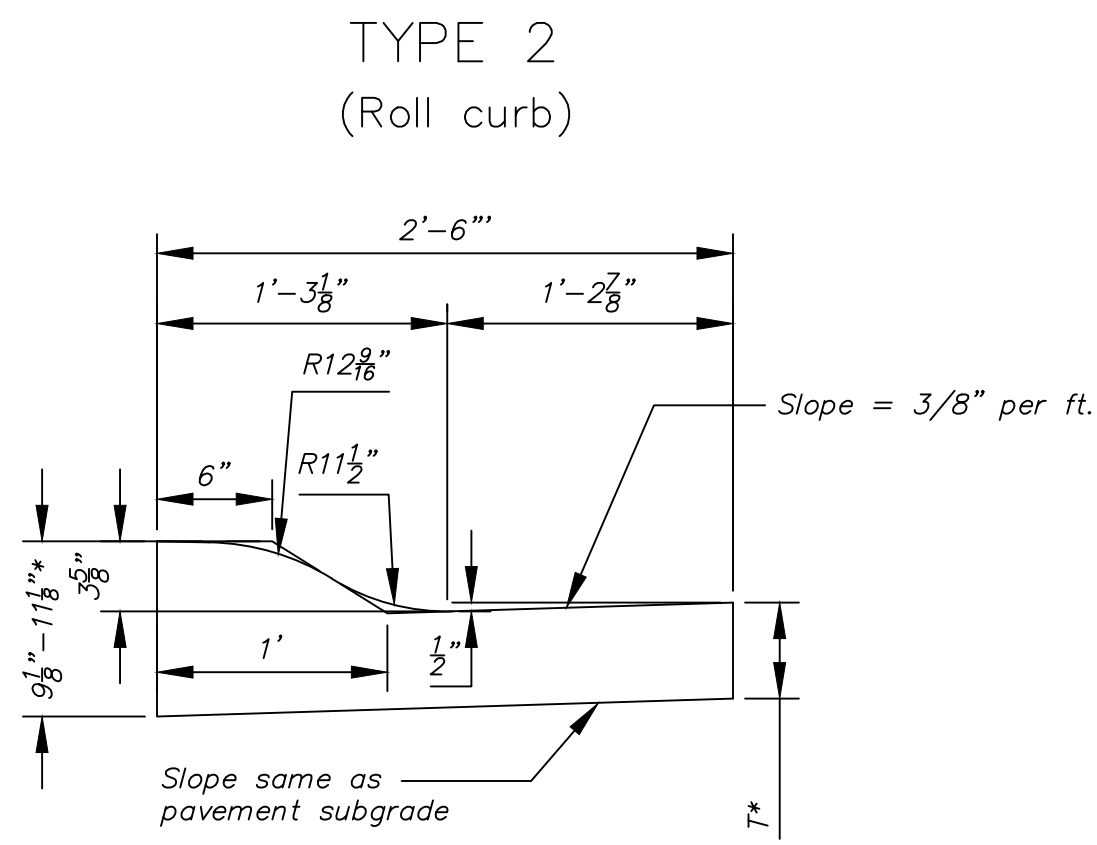

Combined Curb & Gutter (3 5/8")

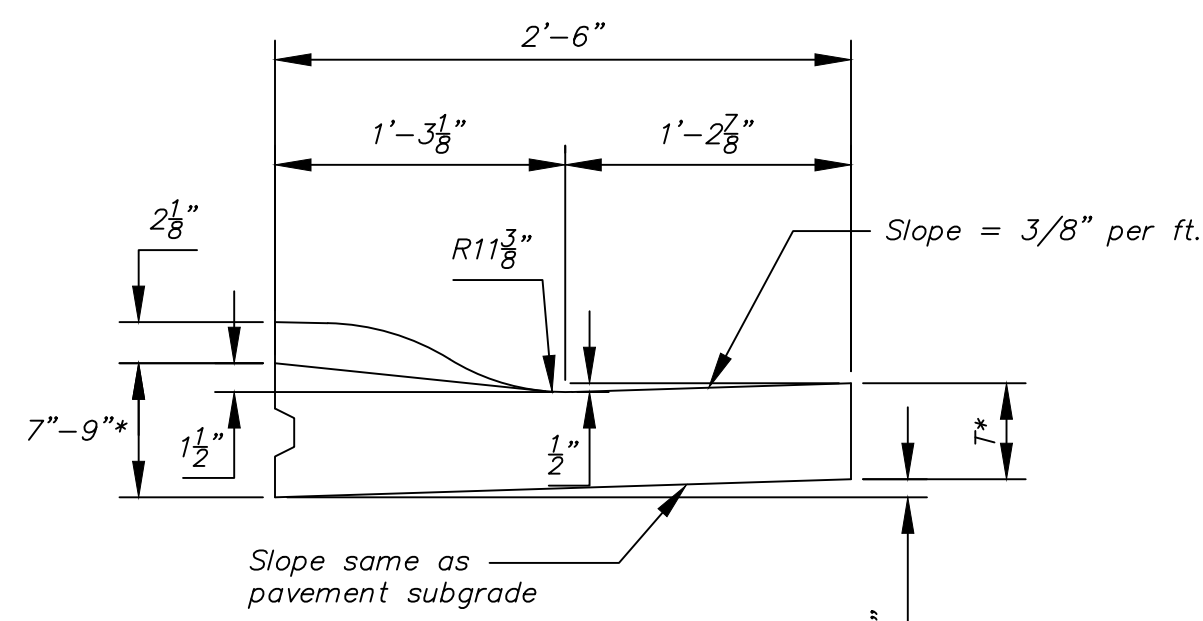

Combined Curb & Gutter (1 1/2")

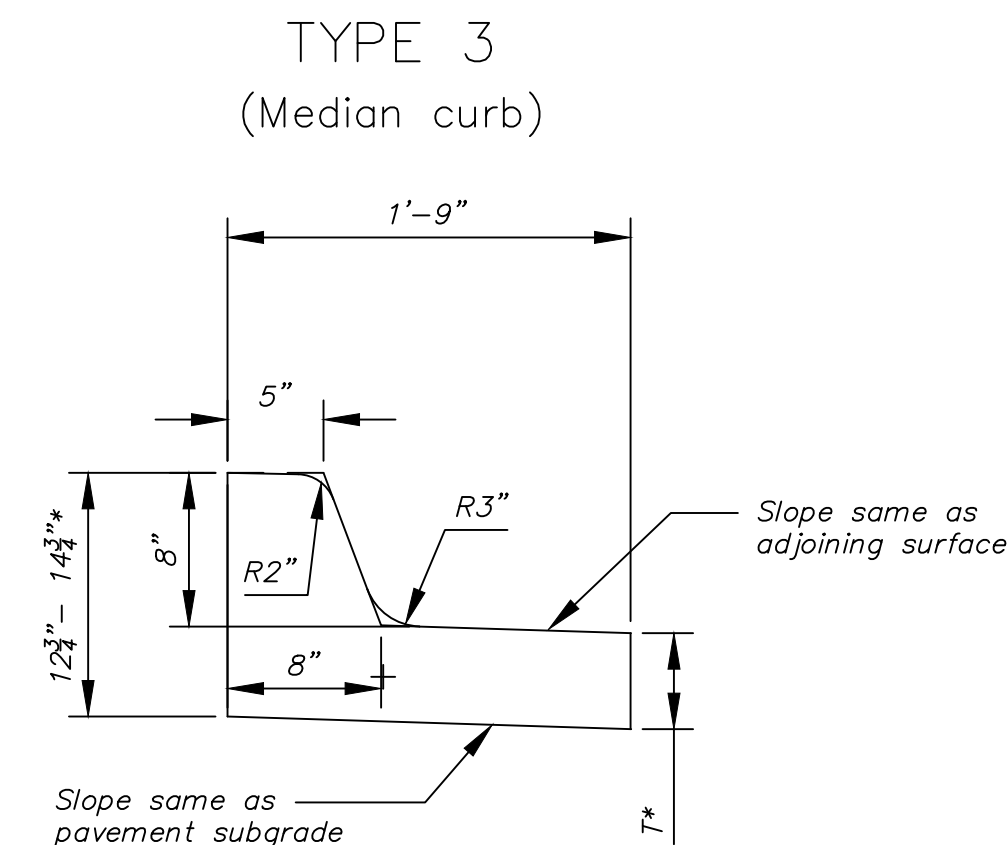

Combined Curb & Gutter (8")

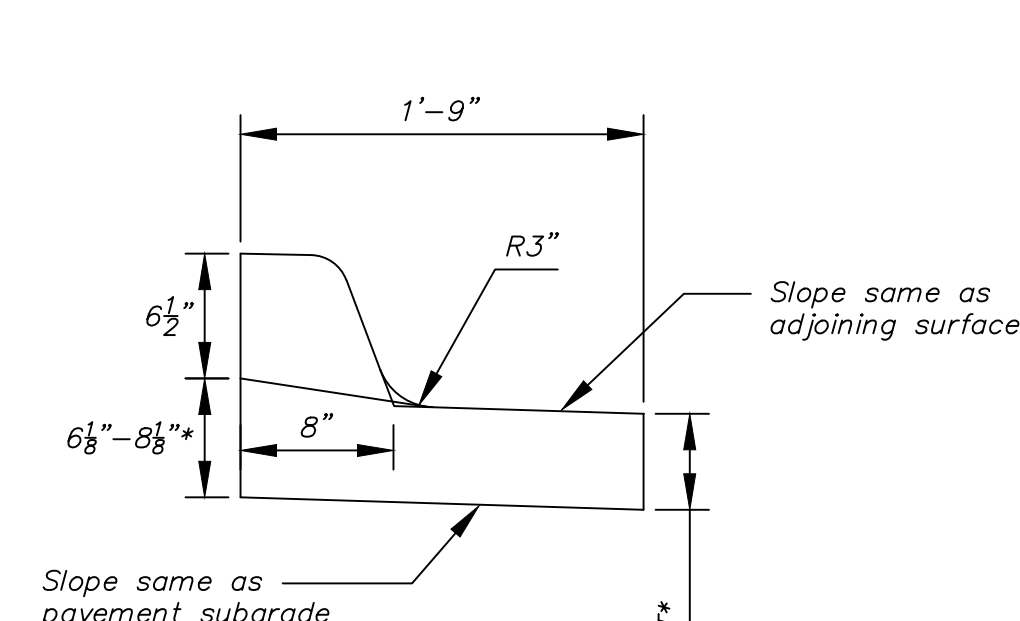

Combined Curb & Gutter (1 1/2")

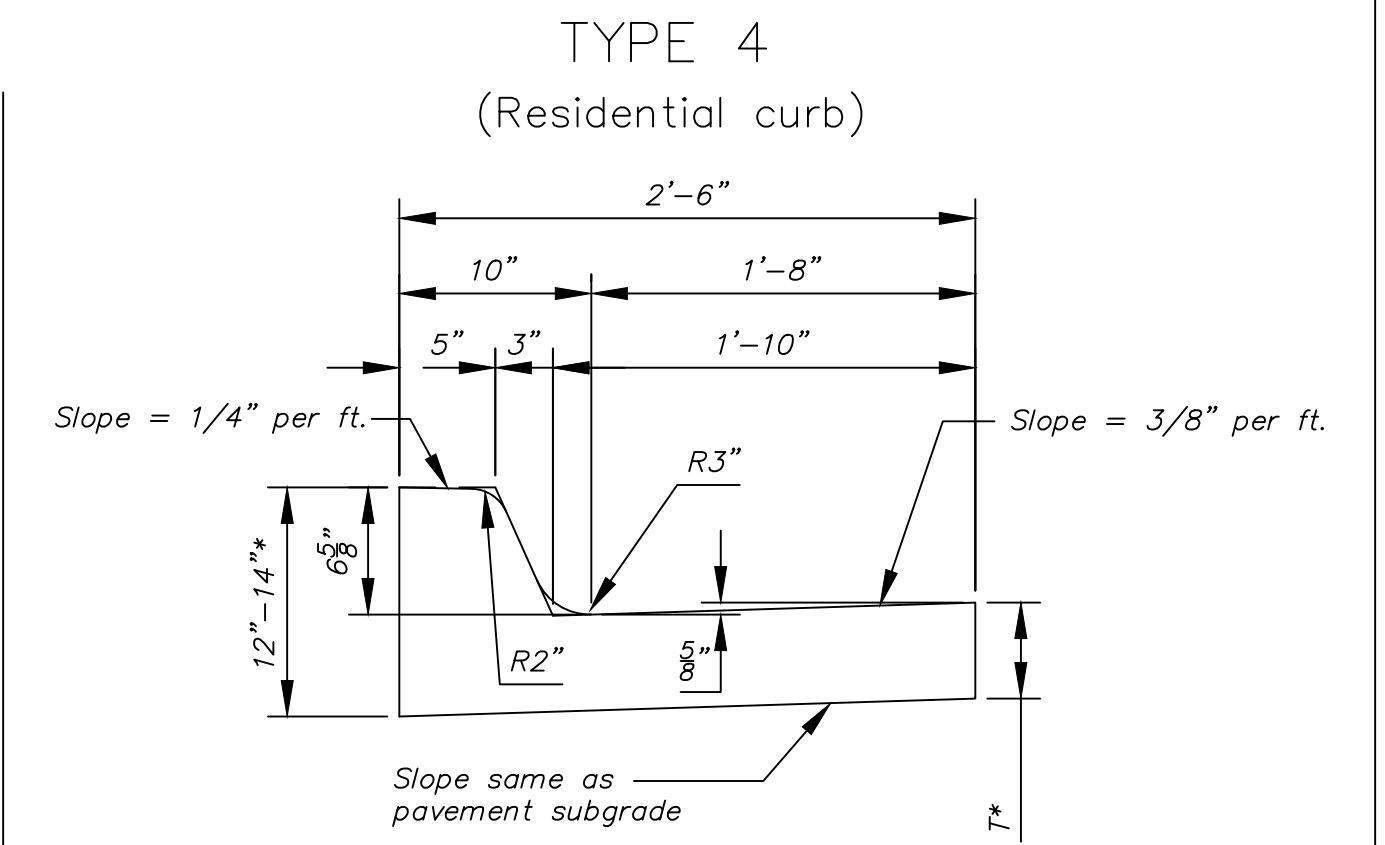

Combined Curb & Gutter (6 5/8")

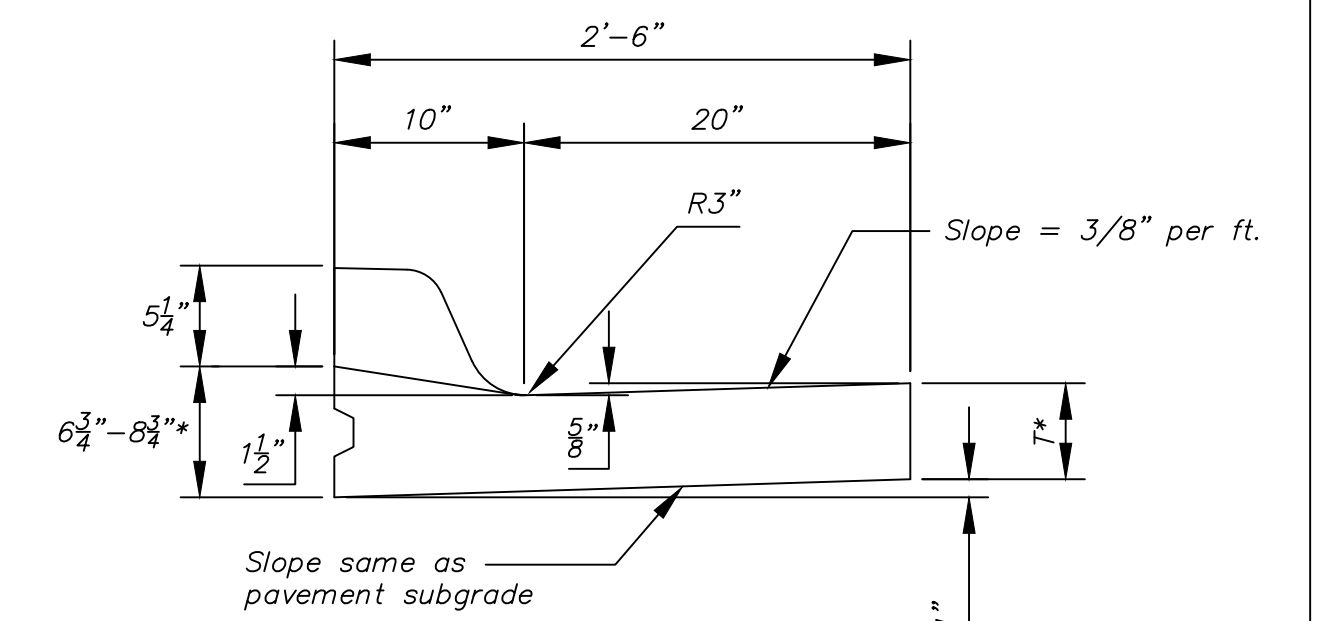

Combined Curb & Gutter (1 1/2")

T\* = Thickness of curb to adjust with pavement thickness

GENERAL NOTES

- Expansion (isolation) joints shall be constructed a maximum of 300' apart and at all PIs, PCs, cul-de-sac quadrants, and ends of returns.
- Contraction joints shall be constructed a minimum of 12' apart.
- Joint sealer shall be required at all joints on arterial and industrial streets and at intersections on residential streets.

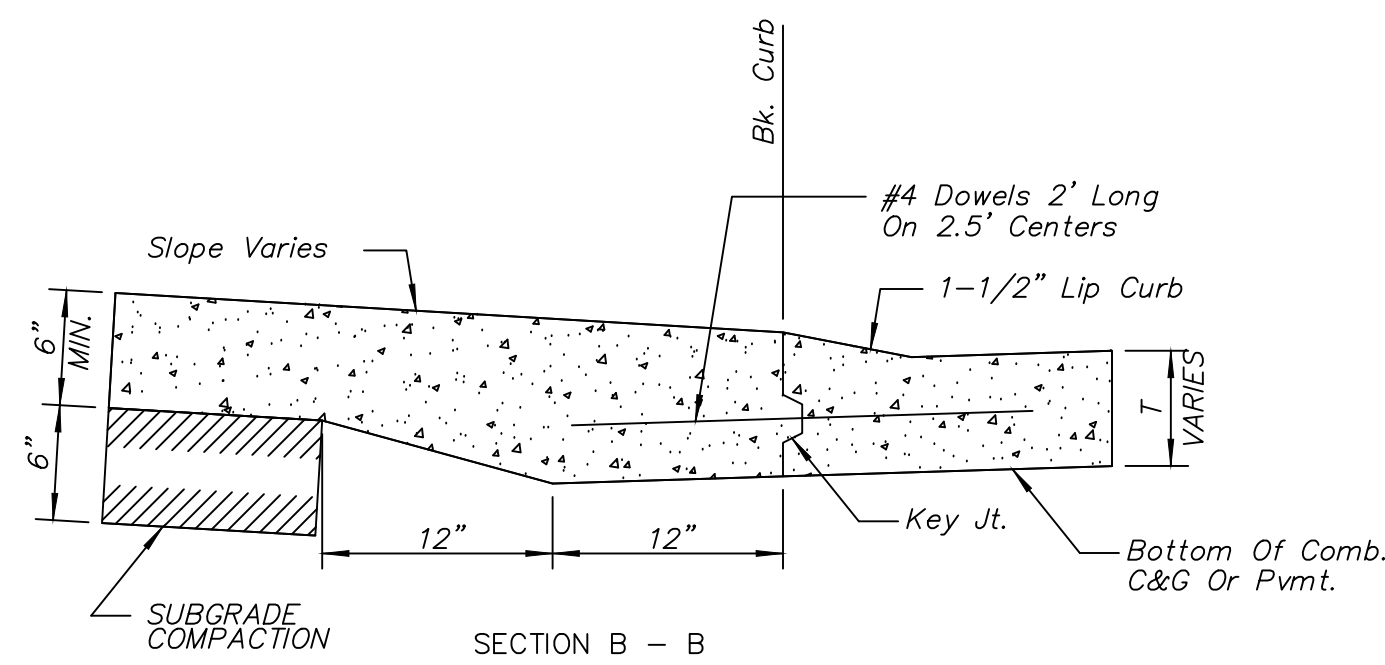

BACK OF CURB DETAIL

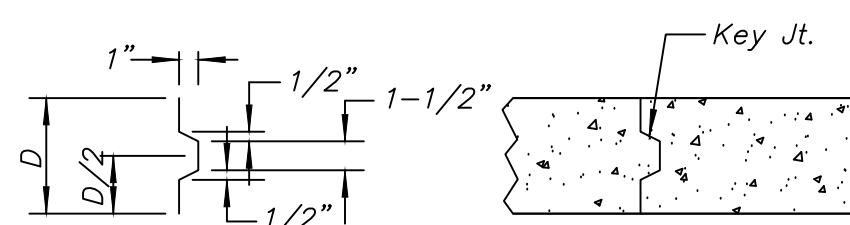

ALT. LONGITUDINAL CONSTRUCTION JOINT

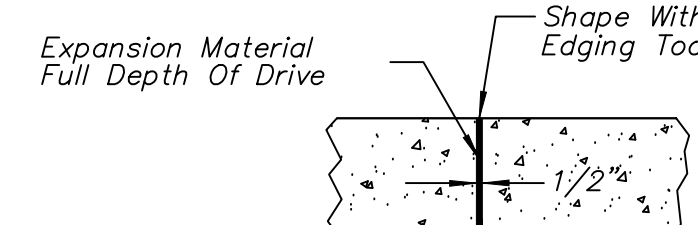

EXPANSION JOINT (E.J.)

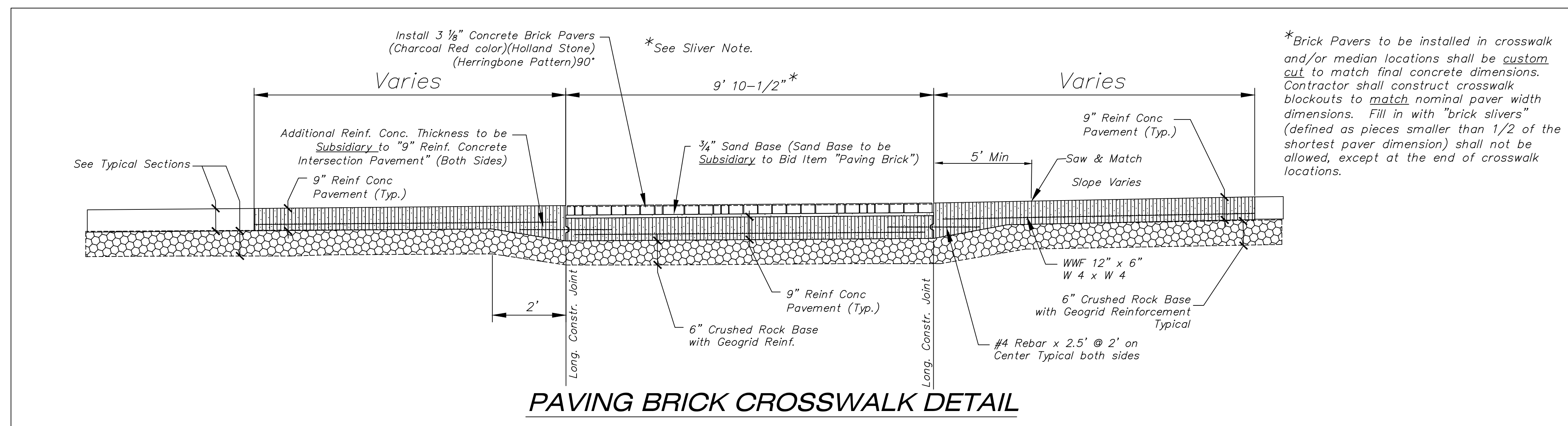

PAVING BRICK CROSSWALK DETAIL



**CITY OF WICHITA**  
PUBLIC WORKS & UTILITIES  
ENGINEERING DIVISION

<p>REVISD: OCTOBER 2015</p> <p><b>CURB &amp; GUTTER &amp; PAVING BRICK CROSSWALK DETAILS</b></p> <p>CITY ENGINEER <b>GARY JANZEN, P.E.</b></p>		
<p>PROJECT NUMBER W0008 448-2020-005233</p>	<p>OCA NUMBER 820022 ORG CODE 54250020</p>	<p>DATE</p>
<p>CITY ENGINEER'S OFFICE CITY HALL - SEVENTH FLOOR 455 NORTH MAIN STREET WICHITA, KANSAS 67202-1620 (316) 268-4501</p>		<p>SHEET <b>12</b> <b>13</b></p>