

HEAVY DUTY (H.D.) COUPLER

NO SCALE

NOTES

1. BOLTS TO BE A-36 1 1/2" DIAMETER.
2. BOLTS, NUTS, WASHERS AND SLEEVES TO BE ZINC PLATED.
3. WASHERS TO BE 3 1/2" O.D. X 7 GAUGE.
4. SHIP WITH NUTS AND WASHERS PLACED ON BOLTS.

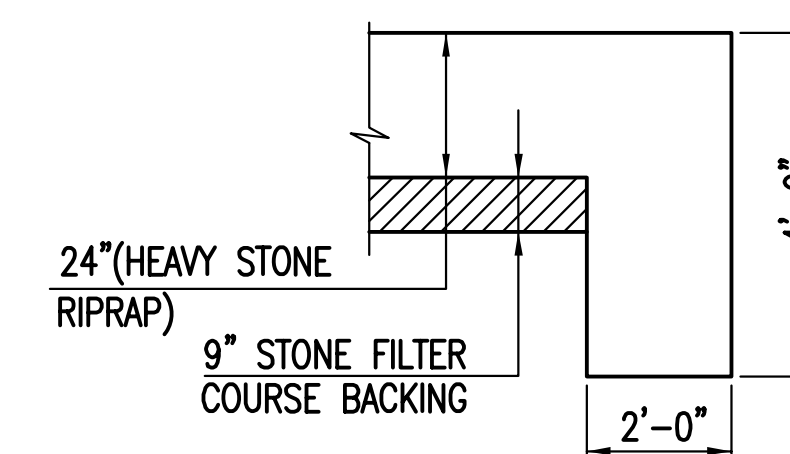

TYPICAL SECTION THRU TOEWALL

NO SCALE

NOTES

1. ALL RIPRAP FOR THIS PROJECT SHALL BE NATURAL STONE. NEITHER BROKEN CONCRETE, FABRIC ENVELOPE, NOR PREMIXED DRY PACKAGED CONCRETE BAG ALTERNATES WILL BE ALLOWED, UNLESS INDICATED OTHERWISE.
2. TOEWALLS SHALL BE INSTALLED ALONG ALL UNPROTECTED EDGES OF STONE RIPRAP.
3. GROUTING OF THE SURFACE OF THE RIPRAP SHALL NOT BE PERFORMED, UNLESS INDICATED OTHERWISE. GROUTING OF THE TOEWALLS SHALL BE PERFORMED PER CITY SPECIFICATIONS.

HEAVY STONE RIPRAP DETAILS

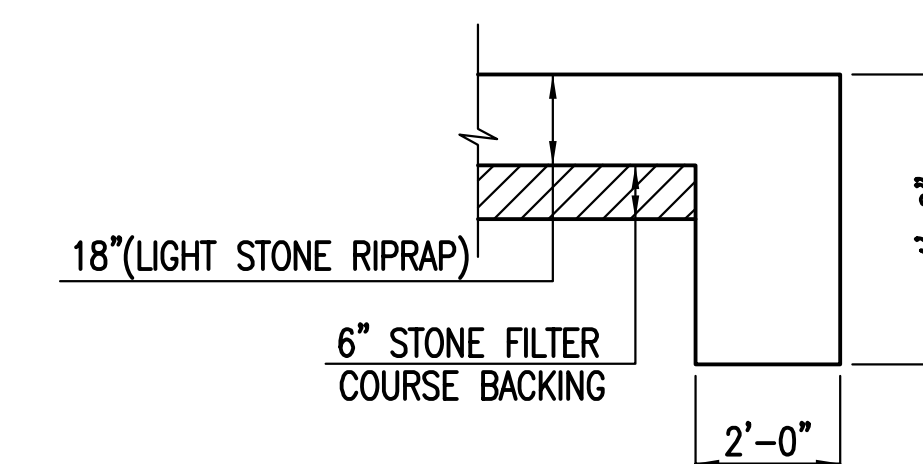

TYPICAL SECTION THRU TOEWALL

NO SCALE

NOTES

1. ALL RIPRAP FOR THIS PROJECT SHALL BE NATURAL STONE. NEITHER BROKEN CONCRETE, FABRIC ENVELOPE, NOR PREMIXED DRY PACKAGED CONCRETE BAG ALTERNATES WILL BE ALLOWED, UNLESS INDICATED OTHERWISE.
2. TOEWALLS SHALL BE INSTALLED ALONG ALL UNPROTECTED EDGES OF STONE RIPRAP.
3. GROUTING OF THE SURFACE OF THE RIPRAP SHALL NOT BE PERFORMED, UNLESS INDICATED OTHERWISE. GROUTING OF THE TOEWALLS SHALL BE PERFORMED PER CITY SPECIFICATIONS.

LIGHT STONE RIPRAP DETAILS



MISCELLANEOUS
DETAILS
(STORM SEWER)

CITY ENGINEER
GARY JANZEN, P.E.

PROJECT NUMBER	OCA NUMBER	DATE
		11/2010

CITY ENGINEER'S OFFICE
CITY HALL - SEVENTH FLOOR
455 NORTH MAIN STREET
WICHITA, KANSAS 67202-1620
(316) 268-4501

SHEET
19 of 24