

J:\PROJECTS\2019\1901010483_COW_37TH STREET WATERLINE_190483 CAD\SHOTS\05 CIVIL\TRAFFIC CONTROL\190483-05-5763.DWG
 PLOTTED: Thursday, December 23, 2021 @ 01:50PM

SIGN LAYOUT INFORMATION

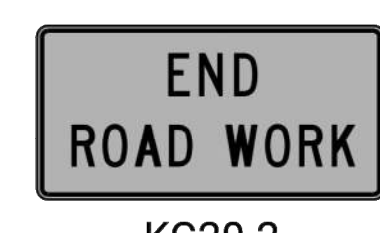

Std. Size
Expwy/Freeway
6" C
48"x 24"



Std. Size
Expwy/Freeway
6" C
48"x 24"



Std. Size
3" C
24"x 6"

Expwy/Freeway
6" C
48"x 12"



Mileage to be Determined
by the Engineer.



Std. Size
Expwy/Freeway
48"x 48"

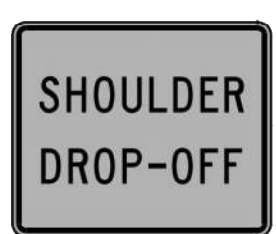

Std. Size
Expwy/Freeway
30"x 24"



Std. Size
6" C

Expwy/Freeway
10" D

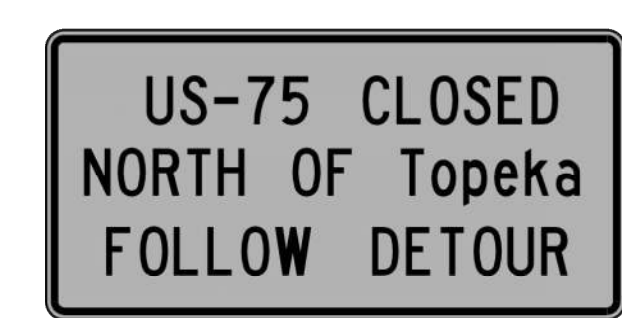

Std. Size
Uppercase: 6" C
Lowercase: 4.5" C

Expwy/Freeway
Uppercase: 10" D
Lowercase: 8" D

All city names and street names on special signs and destination signs must have upper and lower case letters.



Std. Size
Expwy/Freeway
8" D
48"x 48"



Std. Size
Expwy/Freeway
8" D
48"x 48"



Std. Size
Expwy/Freeway
30"x 24"



Std. Size
Expwy/Freeway
8" D
48"x 48"

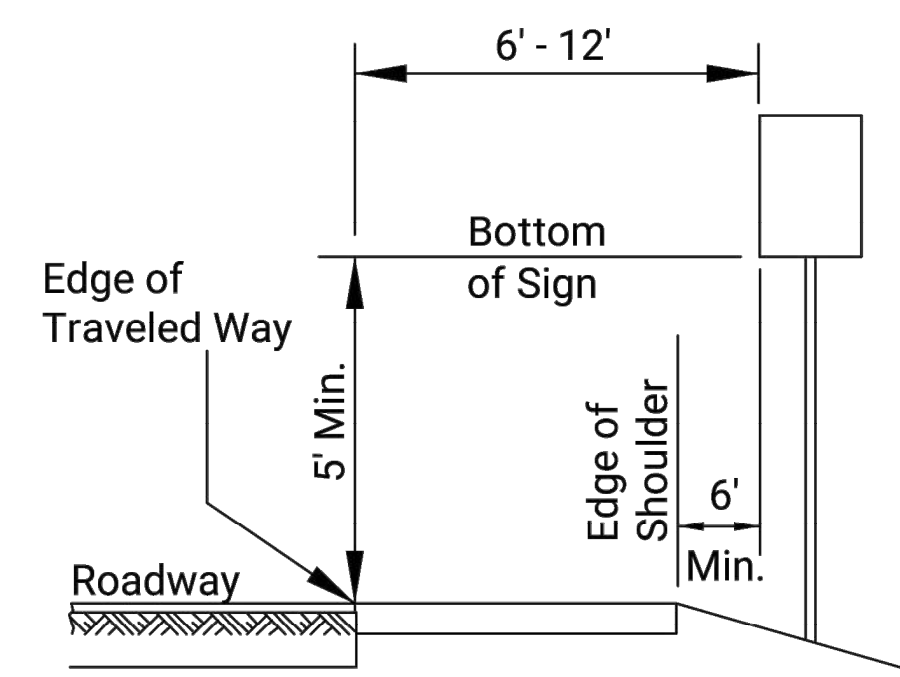

RURAL

- 1) Ground-mounted signs shall be mounted at a minimum height of 5' measured from the bottom of sign to the near edge of the pavement.
- 2) Large signs having an area exceeding 50 square feet installed on multiple breakaway posts shall be mounted a minimum of 7' above the ground.
- 3) The height of the secondary sign mounted below another sign may be 4' measured from the bottom of the sign to the near edge of the pavement. Signs shall not overlap each other.

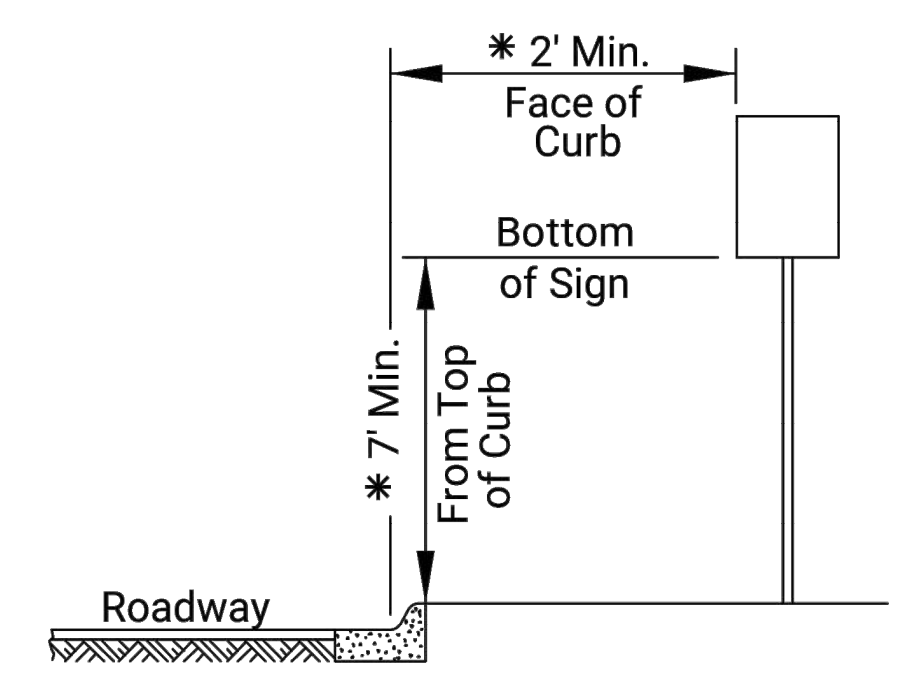

URBAN

- 1) Signs shall be mounted at a minimum height of 7' measured from the bottom of sign to the near edge of the pavement.
- 2) Neither portable nor permanent sign supports should be located on sidewalks or areas designated for pedestrian or bicycle traffic.
- 3) Signs mounted lower than 7' should not project more than 4" into pedestrian facilities.
- 4) The height from of the secondary sign mounted below another sign may be 6' measured from the bottom of sign to the near edge of the pavement. Signs shall not overlap each other.
- 5) Large signs having an area exceeding 50 square feet installed on multiple breakaway posts shall be mounted a minimum of 7' above the ground.
- * 6) Pedestrian detour signing shall be a minimum of 2' measured from the top of the pedestrian pathway to the bottom of the sign and shall not protrude into the walkway nor shall it project beyond the back of curb.

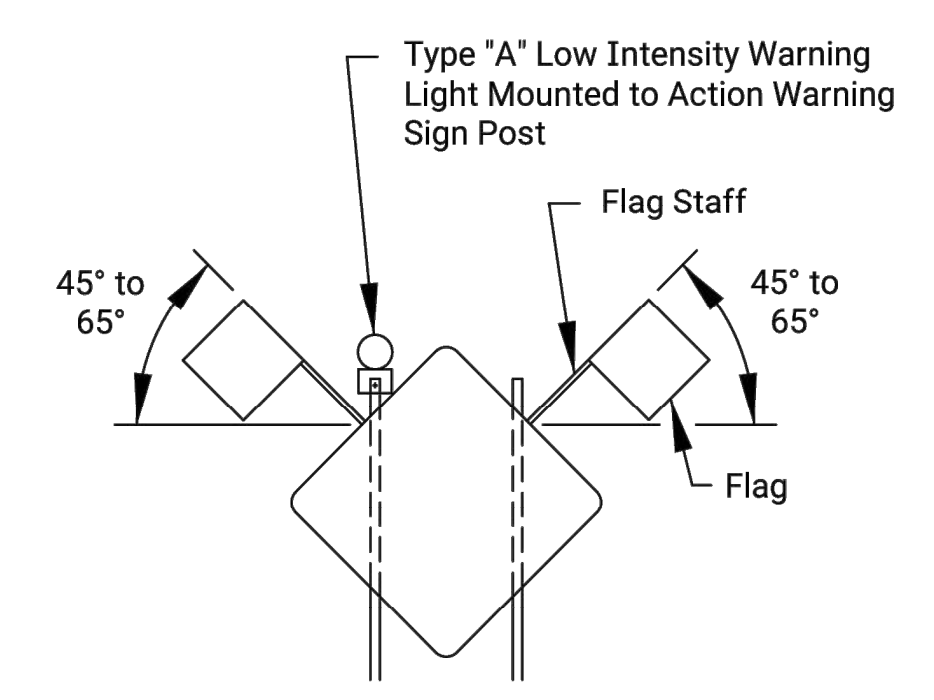

When the sign width is equal to or greater than 9', three or more wood posts may be used with a minimum of 4' between the centerline of each post. All signs less than 9' in width shall use a maximum of two wood posts.

- In the case of hitting rock when driving posts
1. Shift the sign location. Do not violate minimum sign spacing.
 2. With the engineer's approval, use acceptable alternative sign stands.

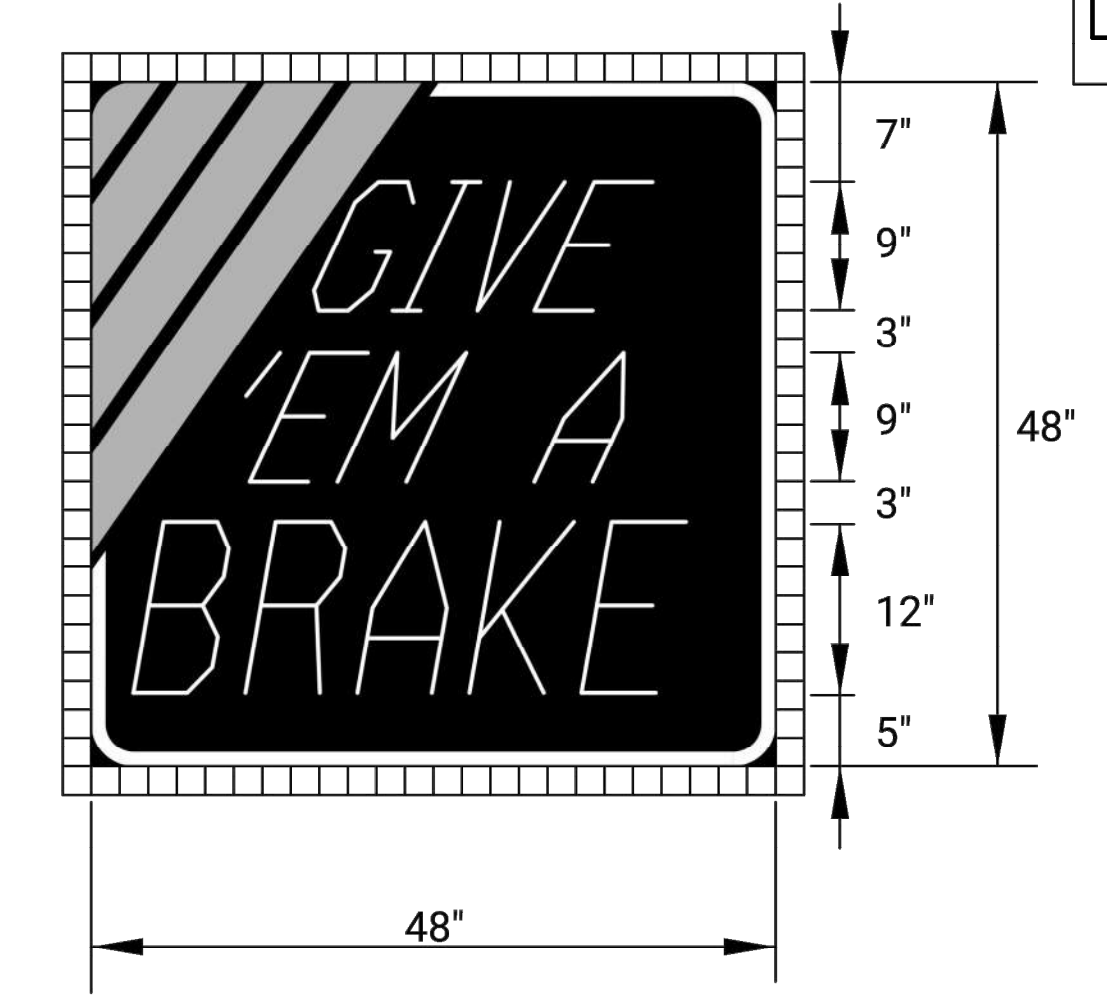

KI-104a

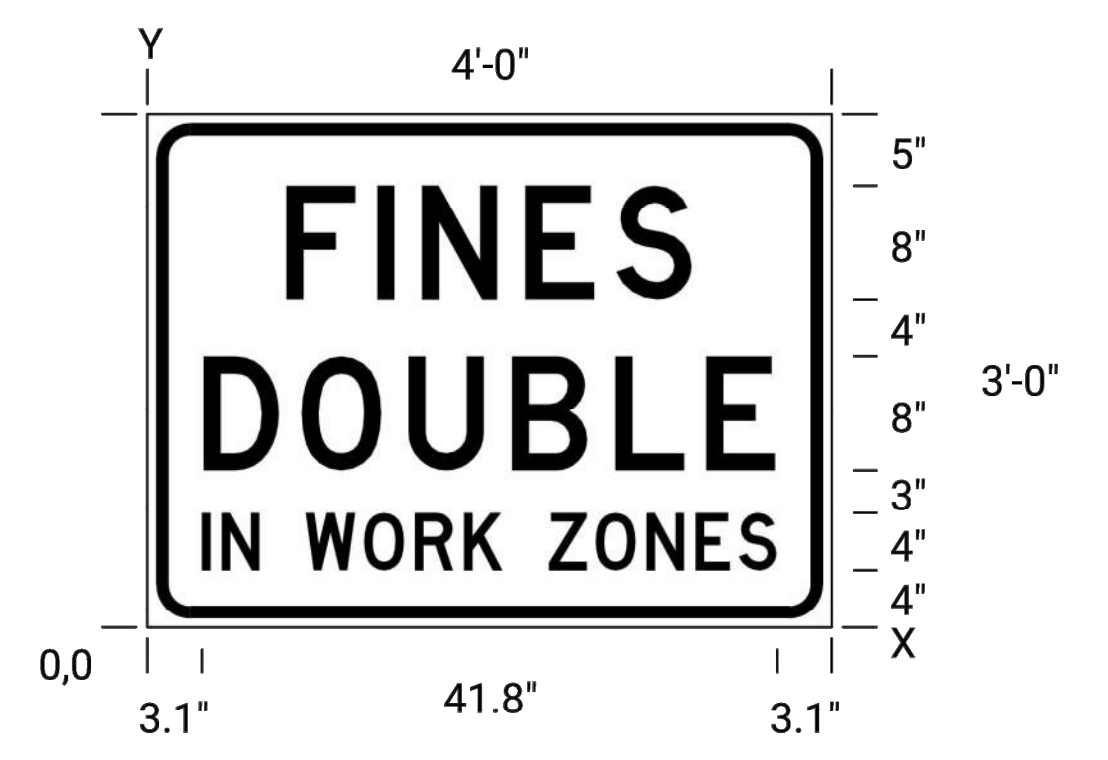

KI-105a

Dimensions in inches Spacings are to start of next letter

Y FONT	LETTER SPACINGS														HT LEN	
23.0	F	I	N	E	S											8.0
D	9.7	6.4	3.2	7.3	6.4	5.4	9.7									28.6
11.0	D	O	U	B	L	E										8.0
D	3.9	6.9	7.5	7.3	7.3	6.4	4.9	3.9								40.3
4.0	I	N	W	O	R	K	Z	O	N	E	S					4.0
D	3.1	1.6	2.7	3.2	4.3	3.8	3.6	2.8	3.2	3.4	3.8	3.6	3.2	2.7	3.1	41.8

Notes:

- Typically, there are two sets of informational signs installed per project: one for each direction of traffic.
- Install signs a minimum of 500' in advance of the road work ahead sign. The engineer may designate a more appropriate location if conditions dictate.
- The informational signs are not to interfere with the traffic control signs for the project.

STATE	PROJECT NO.	YEAR	SHEET NO.	TOTAL SHEETS
KANSAS	1901010483	2022	24	31

Sign Number	GIVE EM A BRAKE
Width x Height	4'-0" x 4'-0"
Border Width	1.0"
Corner Radius	4.0"
Stripe Width	3.0"
Mounting	Ground
Background	Type: Non-Reflective Color: Black
Legend/Border	Type: Reflective Color: White
Legend Font	Dutch 801 Roman SWC 25 Degree Slant
Stripes	Type: Reflective Color: Orange

Sign Number	FINES DOUBLE
Width x Height	4'-0" x 3'-0"
Border Width	0.9"
Corner Radius	3.0"
Mounting	Ground
Background	Type: Reflective Color: White
Legend/Border	Type: Non-Reflective Color: Black



3					
2					
1					
NO.	DATE	REVISIONS	BY	APP'D	
KANSAS DEPARTMENT OF TRANSPORTATION					
TRAFFIC CONTROL SIGN INFORMATION					
TE710					
DESIGNED	R.W.B.	DATE	06/01/15	APP'D	Kristina Pyle
DESIGN CK.	DETAIL CK.	QUAN. CK.		TRACED	