

GENERAL NOTES

STRAW OR HAY BALE NOTES:

1. Place Bales tightly together, with loose straw or hay wedged between Bales to close off any openings.
2. Wood Stakes shall be 2" x 2" (nom.) x 4'-0" long (min.)
3. Use as many Bales as necessary to completely block the entire width of ditch flowline, with excess Bale length cut into fore and back slopes.
4. Use as many Bales as necessary on fore and back slopes to insure water does not flow around barrier.
5. Use only twine to bind bales. The use of wire binding is prohibited because it does not readily biodegrade.

SILT FENCE NOTES:

1. Wood Stakes shall be 2" x 2" (nom.) x 5'-0" long (min.)
2. Attach Fence Fabric to wood stakes with staples, wire, or nails.
3. Use as many wood stakes as necessary to achieve a maximum spacing of 5' across ditch cross section.

TEMPORARY DITCH CHECK SPACING	
DITCH @ SLOPE (%)	SPACING INTERVAL (Ft.)
1.0	200
1.5	133
2.0	100
2.5	80
3.0	66
3.5	57
4.0	50
4.5	44
5.0	40
5.5	38
6.0	35
6.5	30
7.0	28
7.5	26
8.0	25
8.5	23
9.0	22
9.5	21
10.0	20

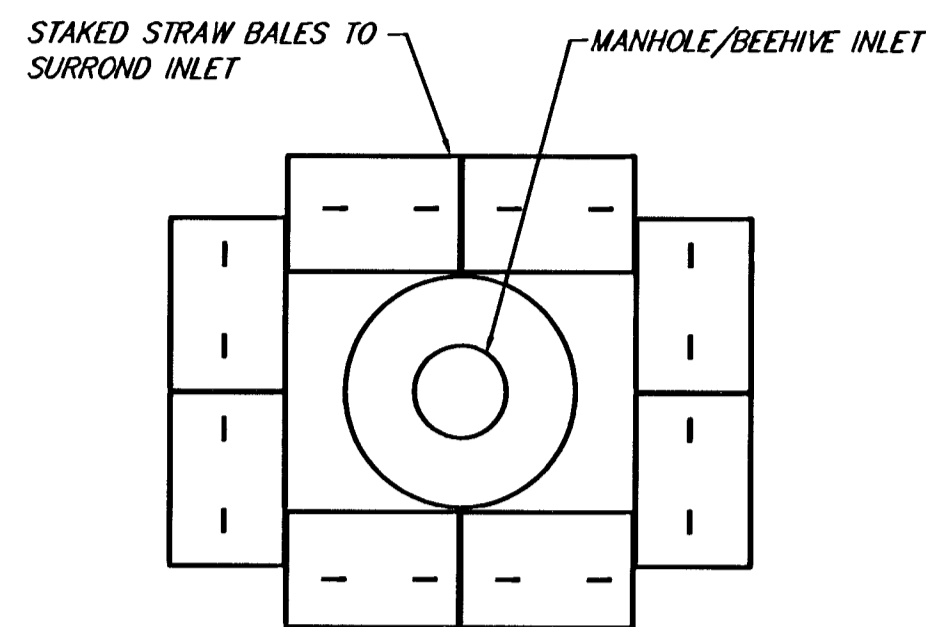

STRAW BALE INLET  
SEDIMENT BARRIER  
DETAIL

DANDY BAG™ PATENT PENDING SPECIFICATIONS  
AND FACT SHEET

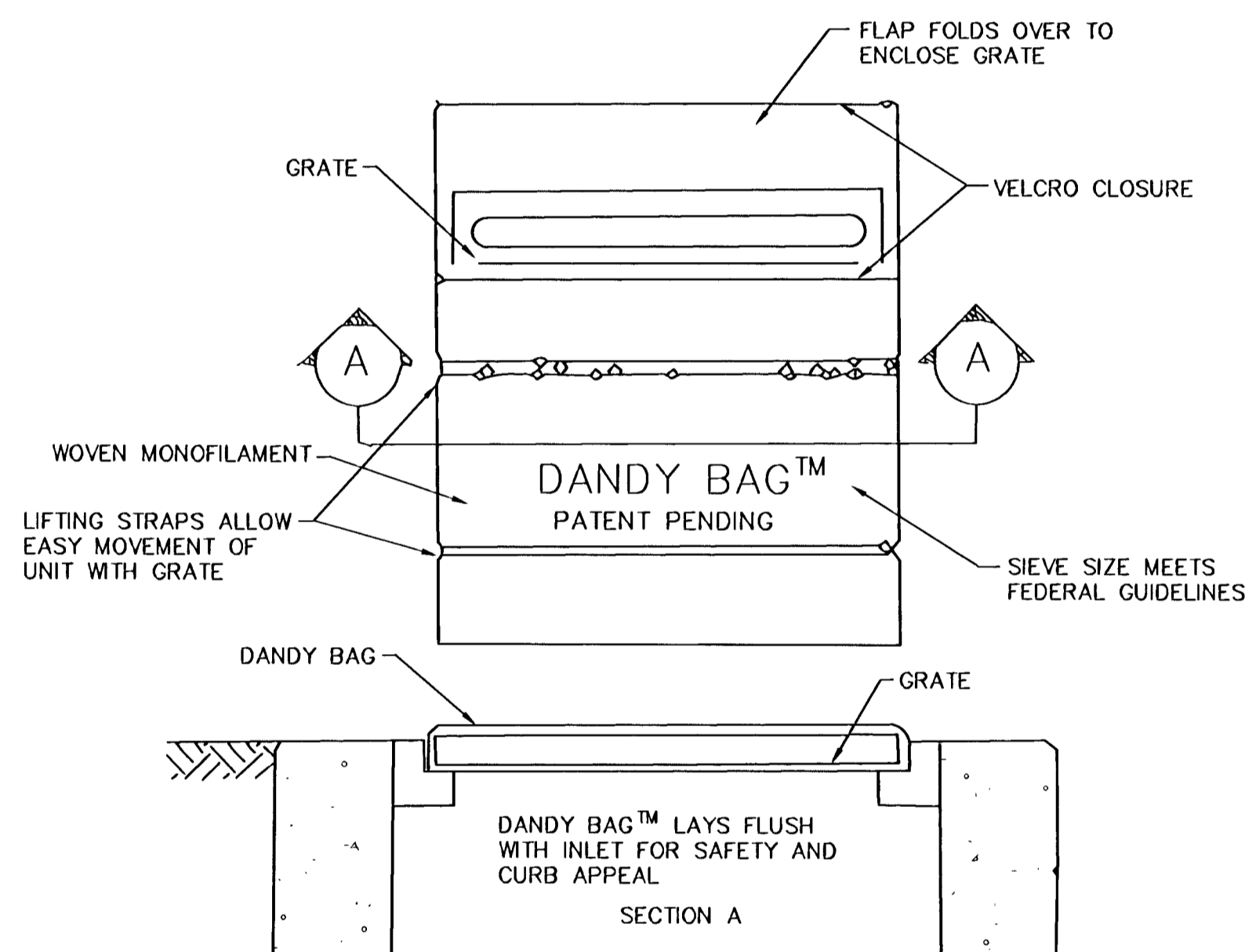

Installation: Stand grate on end. Place Dandy Bag™ over grate. Roll grate over so that open end is up. Pull up slack.

Tuck flap in and press velcro strips together. Be sure end of grate is completely covered by flap or Dandy Bag™ will not work properly.

Holding handles, carefully place Dandy Bag™ with grate inserted into catch basin frame.

Maintenance: With a stiff bristle broom or square point shovel. Remove silt & other debris off surface after each event. Remove fine material from inside envelope as needed.

Inspection: Remove unit with grate inside, inspect catch basin and replace unit.

MINIMUM AVERAGE FABRIC VALUES

PROPERTIES	TEST METHOD	TEST METHOD
Grab Tensile Strength (lb)(warp/fill)	ASTM D 2632	360/260
Grab Elongation (%)(warp/fill)	ASTM D 4632	27/15
Trapezoid Tear (lb)(warp/fill)	ASTM D 4593	100/80
Puncture (lb)	ASTM D 4833	130
Mullen Burst (psi)	ASTM D 3786	515
Ultra-Violent Resistance (% @ 500 hrs.)	ASTM D 2355	90%
Apparent Opening Size (U.S. sieve size)	ASTM D 4751	30
Permittivity (sec <sup>-1</sup> )	ASTM D 4891	110
Permeability k (cm/sec)	ASTM D 4491	05
Open Area (%)	COE0221586	11%
Mass per Unit Area (oz/SY)	ASTM D 5261	58
Water Flow Rate (gpm/sf)	ASTM D 4891	110

DANDY PRODUCTS Inc  
2011-R Harrisburg Pike  
Grove City, Ohio 43123

FAX 614-875-6305  
e-mail: dandy@oscine1.com

800-591-2284  
614-875-2280 local

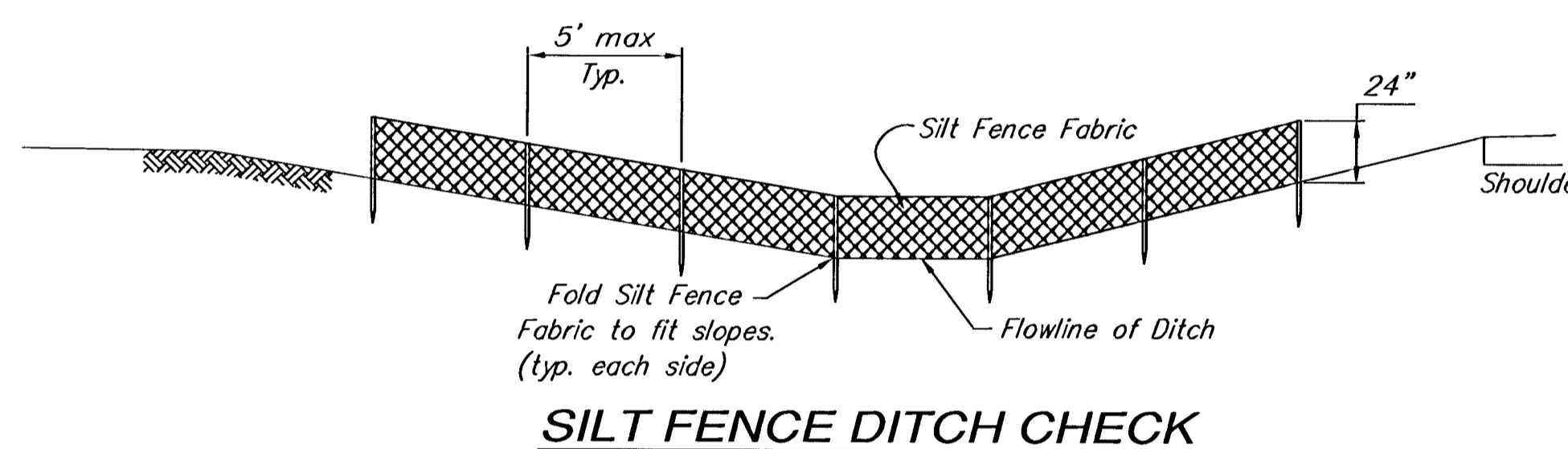

SILT FENCE DITCH CHECK

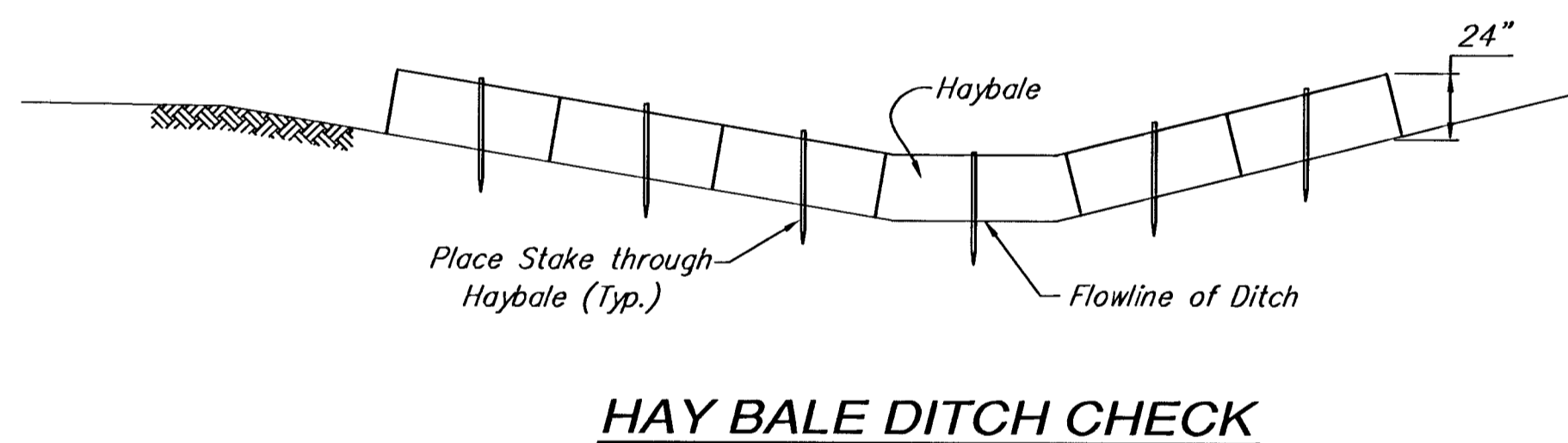

HAY BALE DITCH CHECK

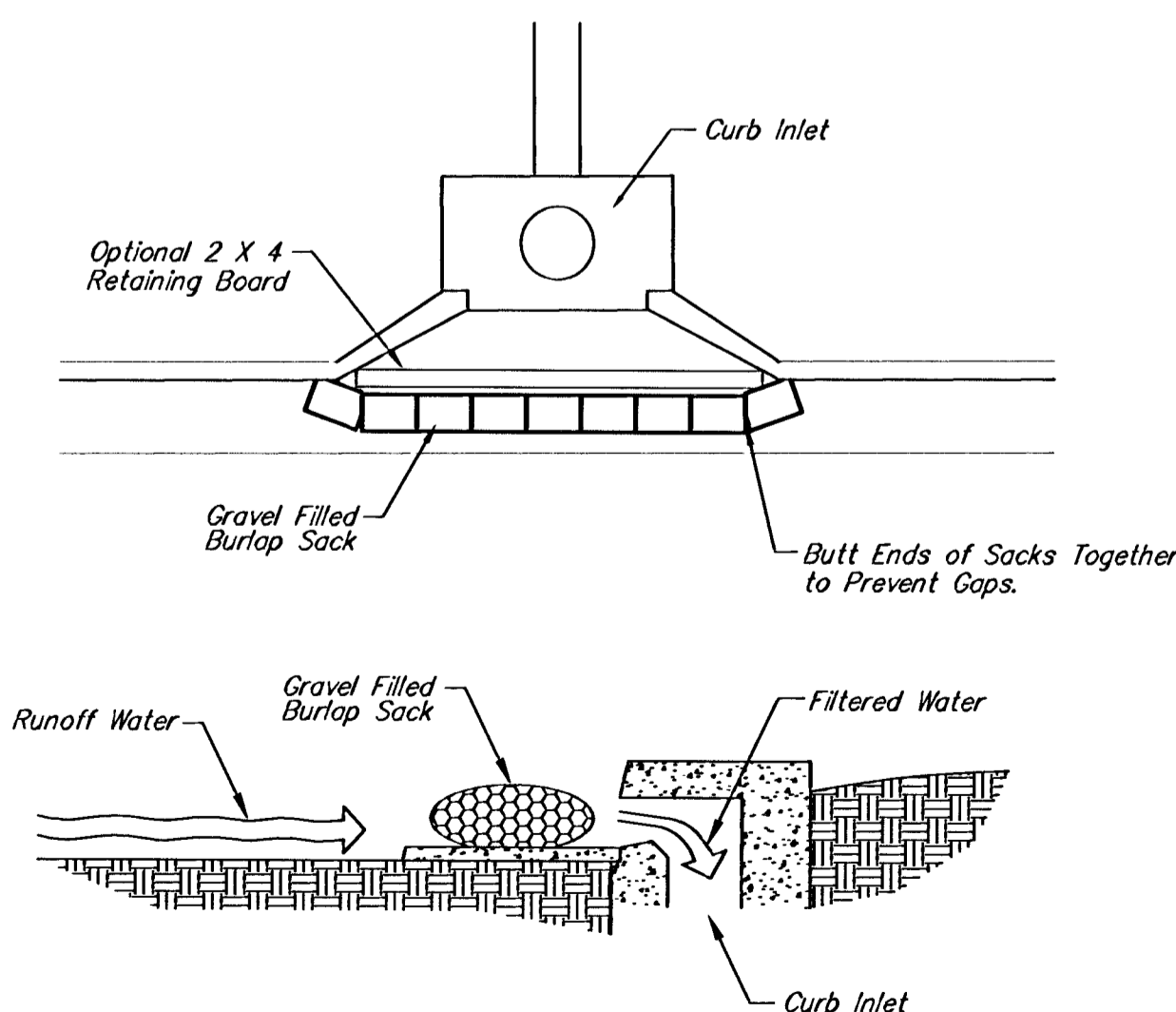

Note: Sacks to be filled with 1" to 3" Clean Gravel

CURB INLET SEDIMENT BARRIER

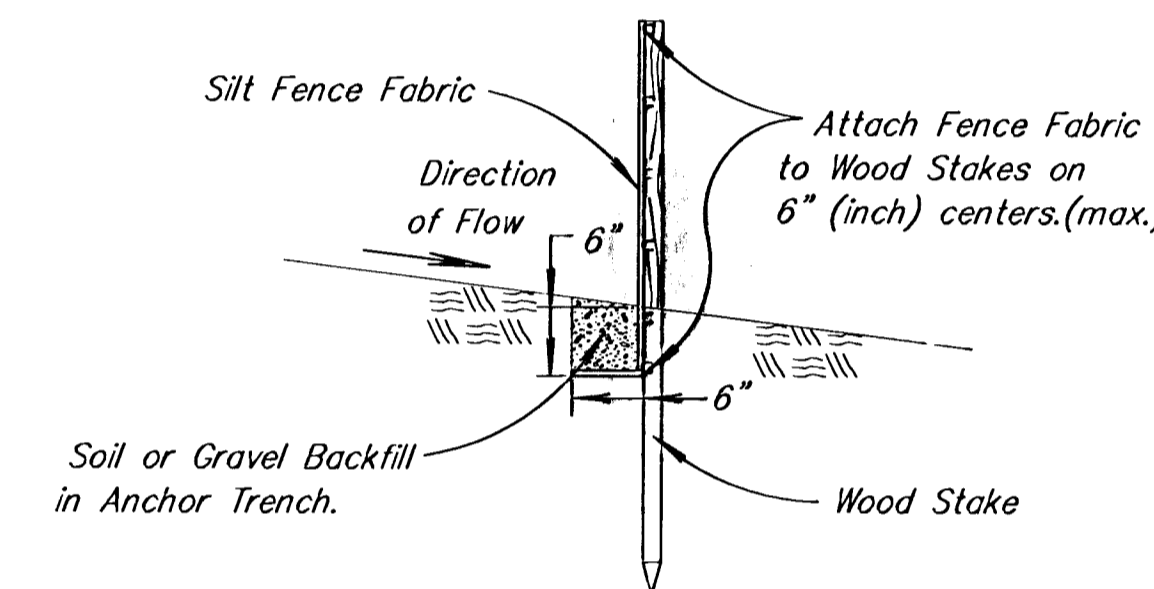

SILT FENCE DITCH CHECK SECTION

NOTE: For clarity of details, this view has been enlarged.

EROSION CONTROL  
SUMMARY

	Gravel Sediment Barriers	Hay Bales	Silt Fence Ditch Check (L.F.)
Inlets	-	-	-
Manholes	-	-	-
Other	-	-	-

Note: For Information Only

MISCELLANEOUS  
EROSION CONTROL  
DETAILS

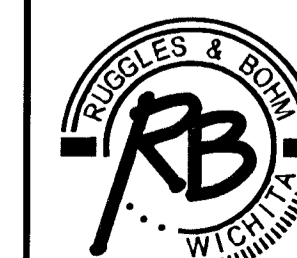

Ruggles & Bohm, P.A.  
Engineering, Surveying, Land Planning  
924 North Main (316) 264-8008  
Wichita, Kansas 67203 (316) 264-4621 fax  
www.rbkansas.com E-mail: info@rbkansas.com

DRAWING FILE  
Storm Sewer [BMP Detail]

PROJECT NUMBER

DESIGN	9	OF	10
DRAWN			
REVIEW			
UTILITY			
DATE	July 15, 1999		