

$EXC = 97.96$ C.Y.
 $LF = 1.50$ C.Y.
 $CF = 0.00$ C.Y.

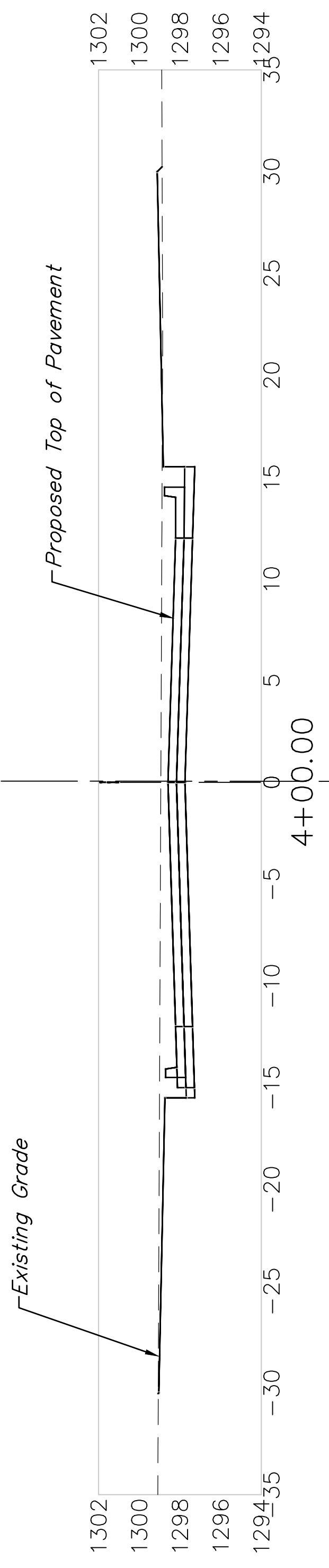

$EXC = 75.21$ C.Y.
 $LF = 9.37$ C.Y.
 $CF = 0.00$ C.Y.

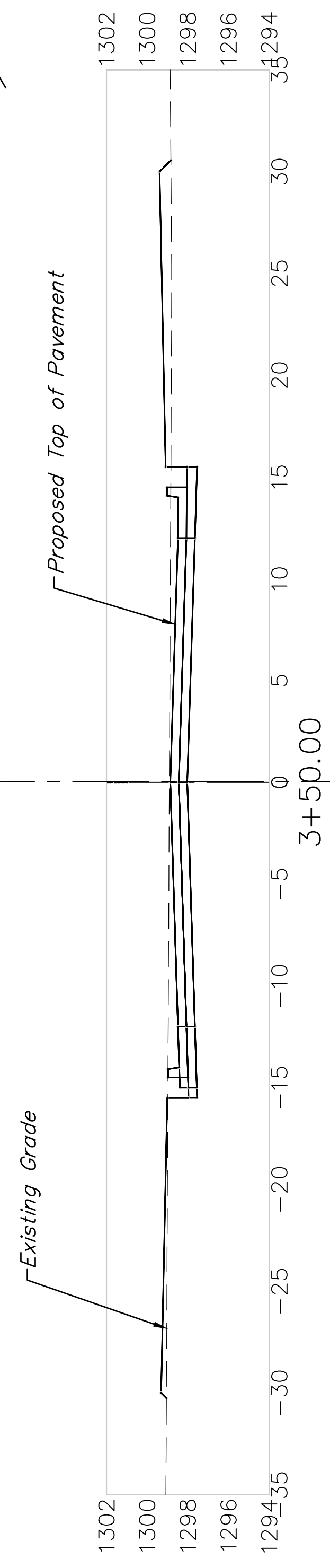

$EXC = 63.07$ C.Y.
 $LF = 17.23$ C.Y.
 $CF = 0.00$ C.Y.

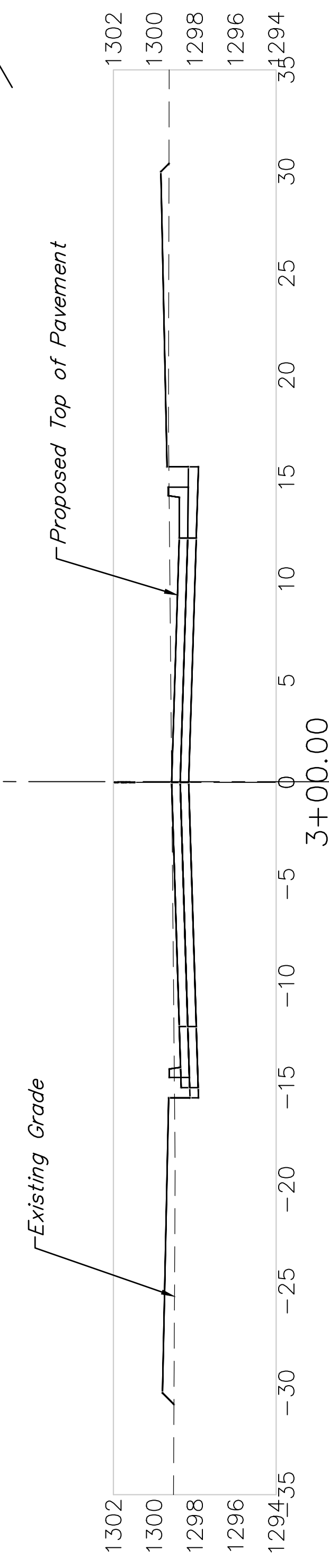

$EXC = 45.37$ C.Y.
 $LF = 33.36$ C.Y.
 $CF = 0.00$ C.Y.

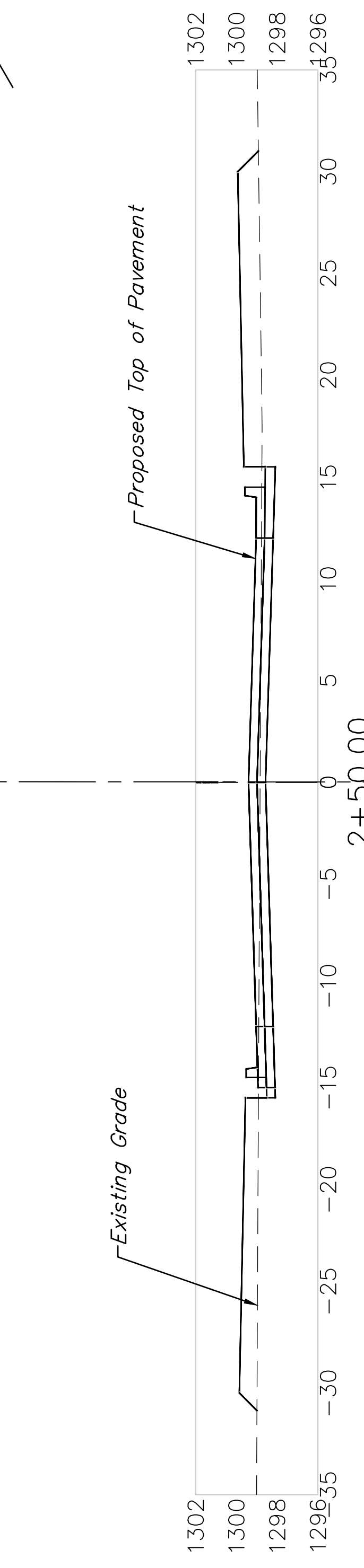

$EXC = 22.39$ C.Y.
 $LF = 55.70$ C.Y.
 $CF = 0.00$ C.Y.

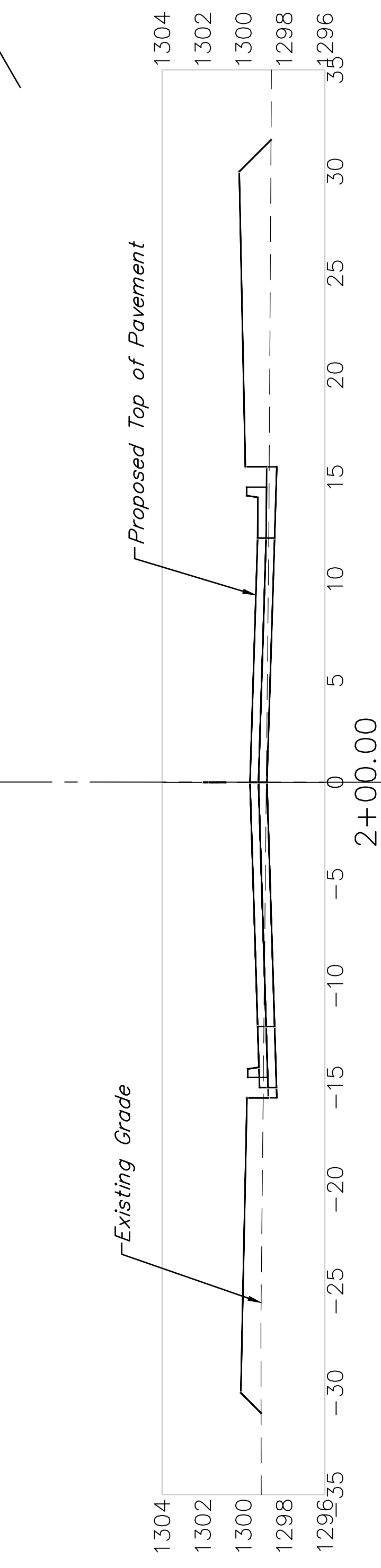

$EXC = 16.81$ C.Y.
 $LF = 61.15$ C.Y.
 $CF = 0.00$ C.Y.

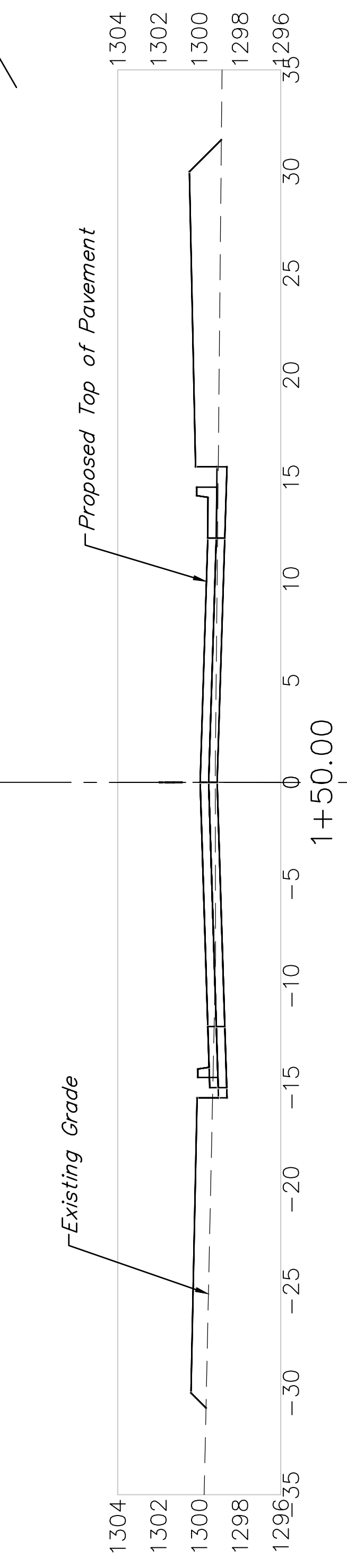

Doris Ct (Lots 10 through 25, Block B)