

$EXC = 107.30$ C.Y.
 $LF = 0.69$ C.Y.
 $CF = 0.00$ C.Y.

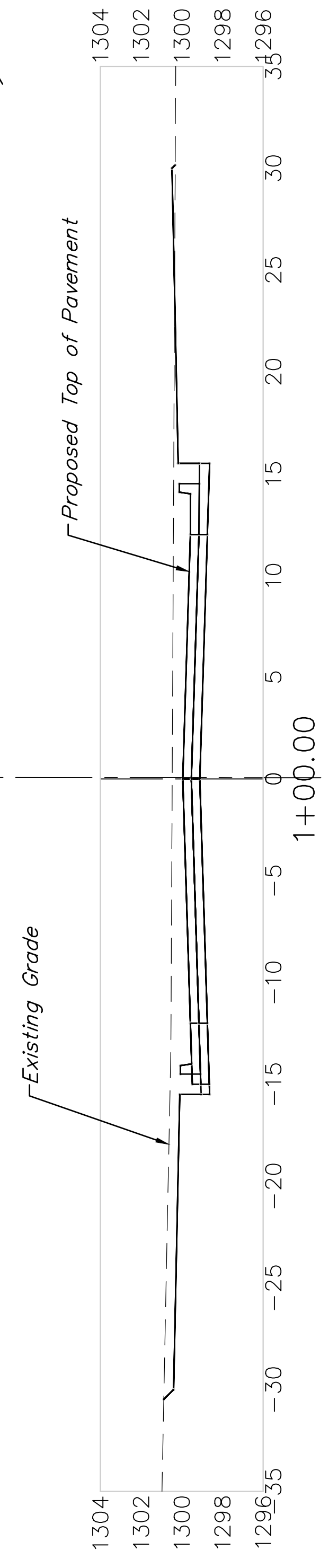

$EXC = 125.90$ C.Y.
 $LF = 0.94$ C.Y.
 $CF = 0.00$ C.Y.

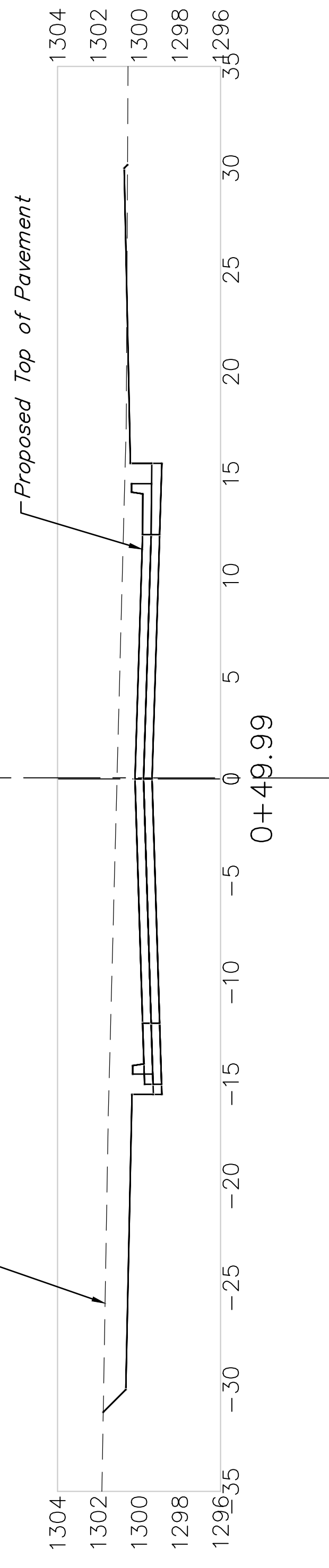

$EXC = 88.91$ C.Y.
 $LF = 0.36$ C.Y.
 $CF = 0.00$ C.Y.

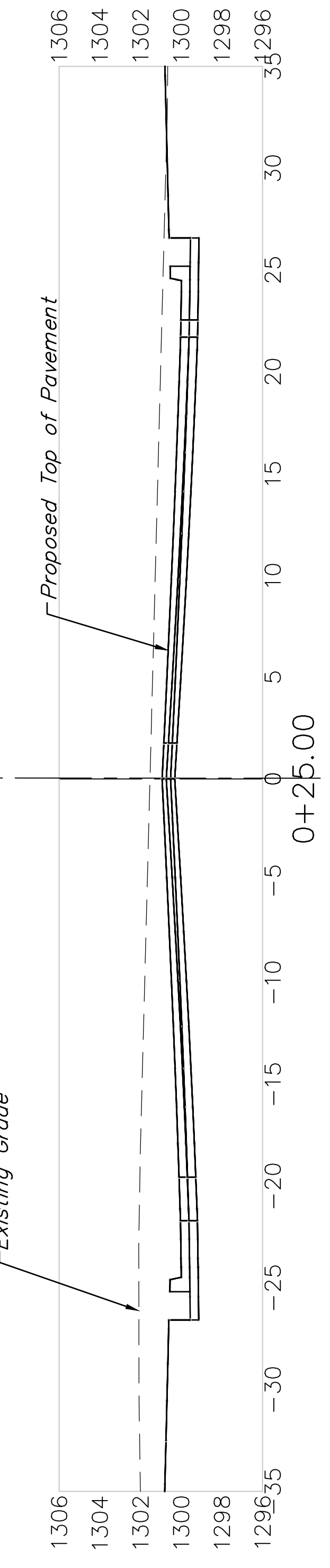

$EXC = 105.00$ C.Y.
 $LF = 2.78$ C.Y.
 $CF = 0.00$ C.Y.

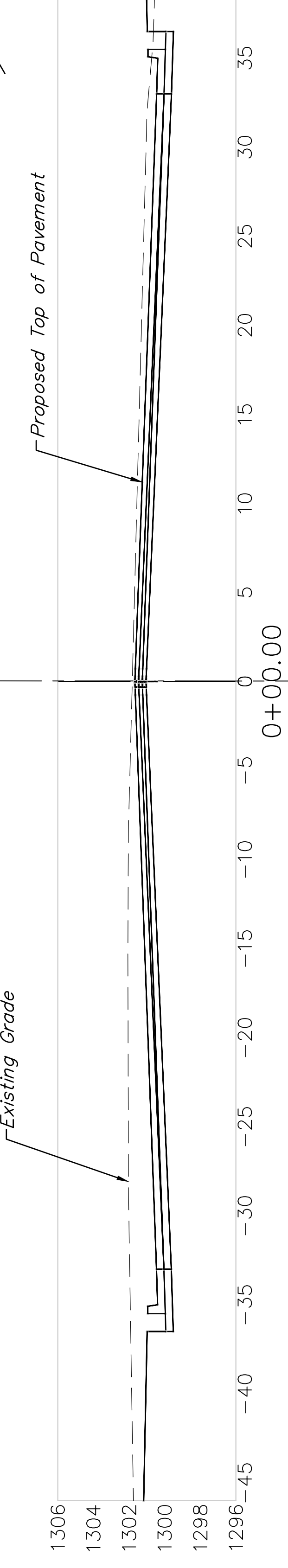

$EXC = 60.16$ C.Y.
 $LF = 4.56$ C.Y.
 $CF = 0.00$ C.Y.

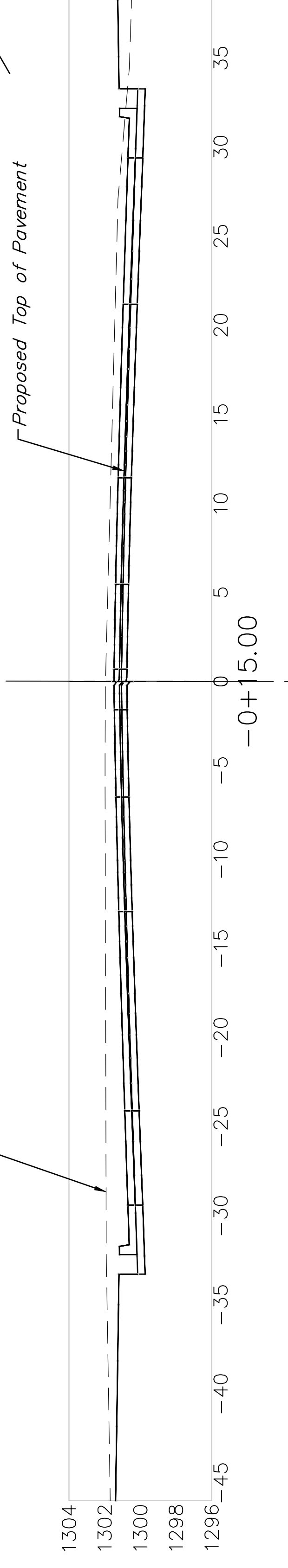

$EXC = 52.47$ C.Y.
 $LF = 7.28$ C.Y.
 $CF = 0.00$ C.Y.

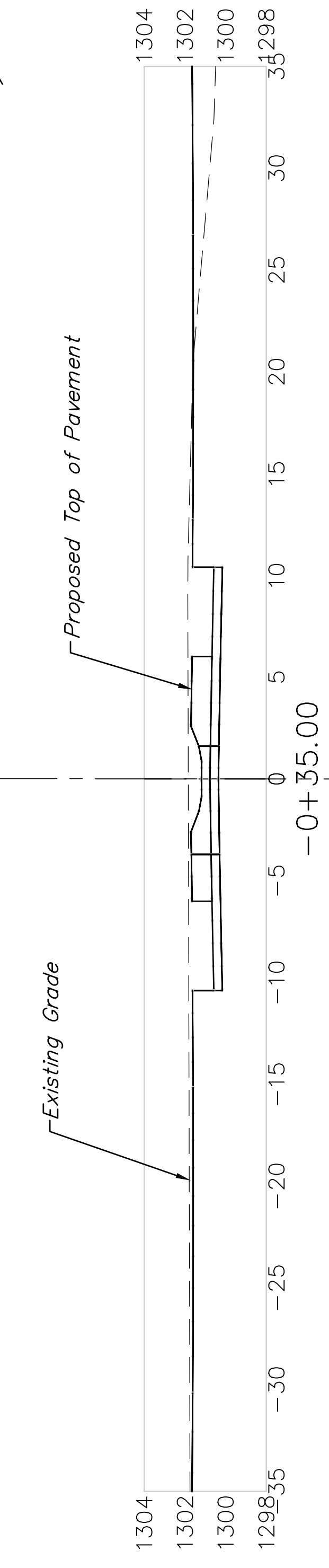

Doris Ct (Lots 26 through 41, Block B)