

$EXC = 46.60$ C.Y.
 $LF = 7.28$ C.Y.
 $CF = 0.00$ C.Y.

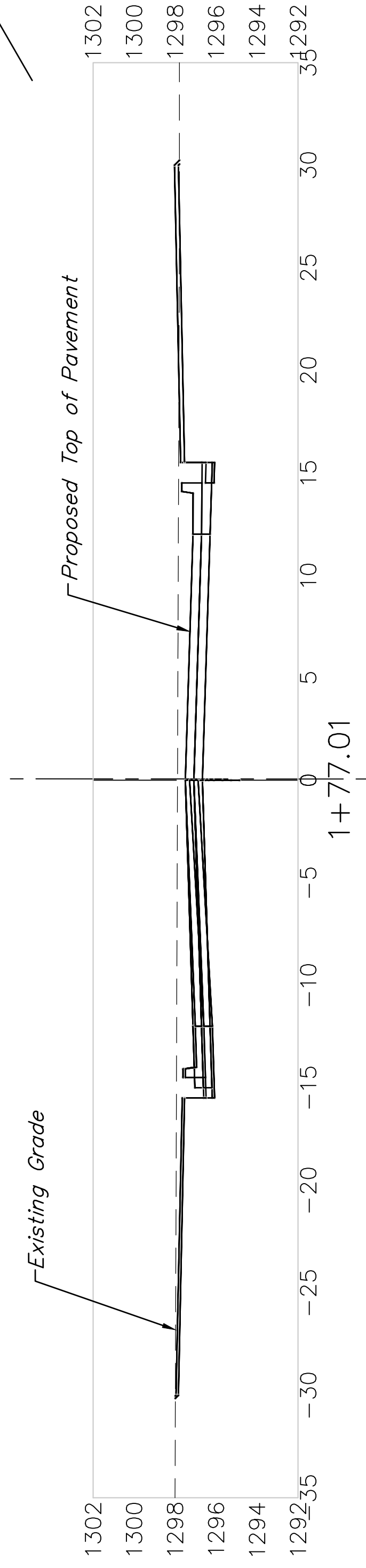

$EXC = 45.14$ C.Y.
 $LF = 1.27$ C.Y.
 $CF = 0.00$ C.Y.

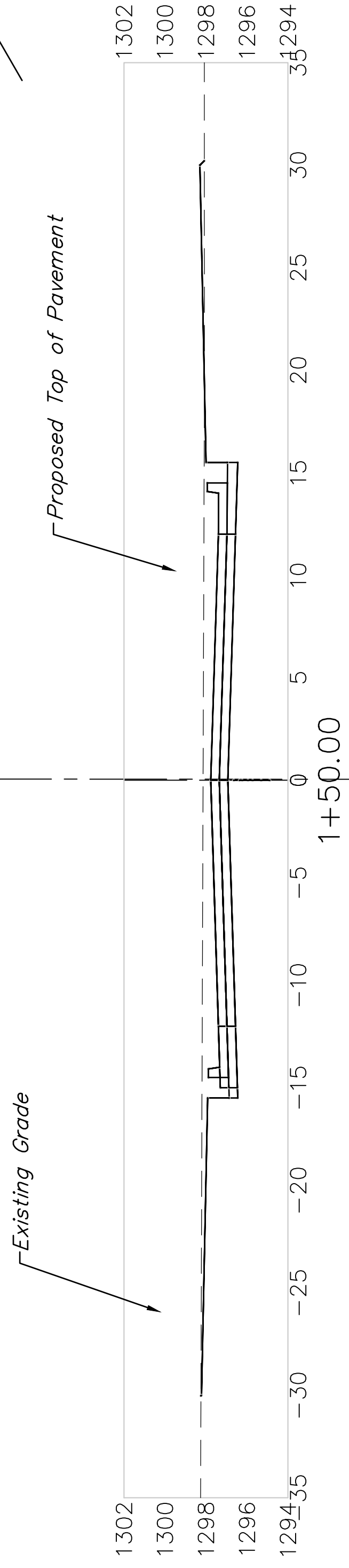

$EXC = 99.14$ C.Y.
 $LF = 1.10$ C.Y.
 $CF = 0.00$ C.Y.

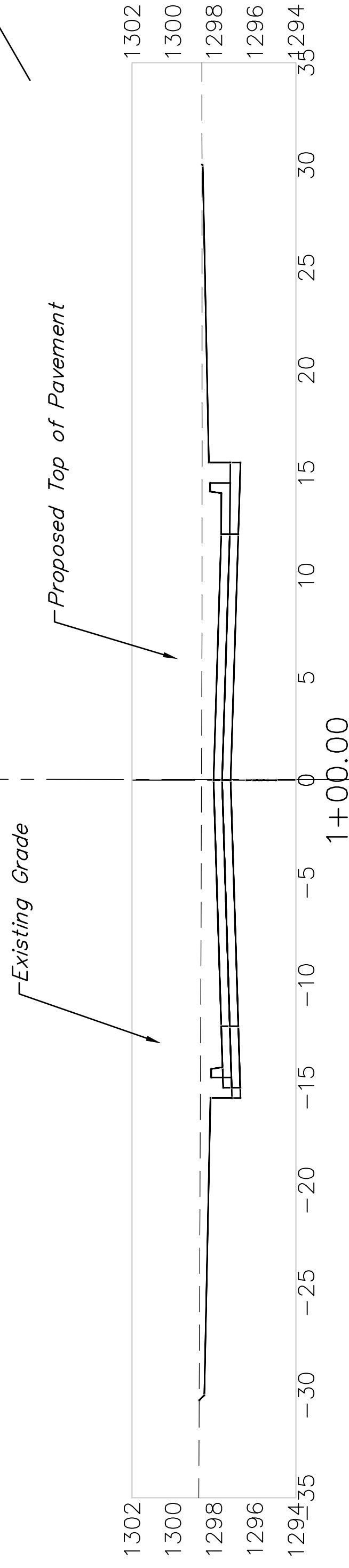

$EXC = 59.21$ C.Y.
 $LF = 0.00$ C.Y.
 $CF = 0.00$ C.Y.

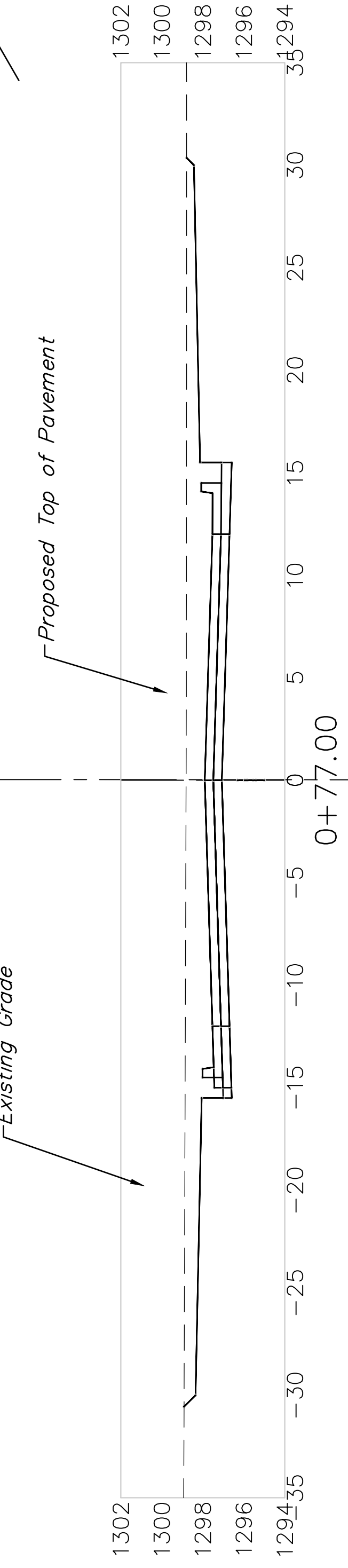

$EXC = 91.01$ C.Y.
 $LF = 0.00$ C.Y.
 $CF = 0.00$ C.Y.

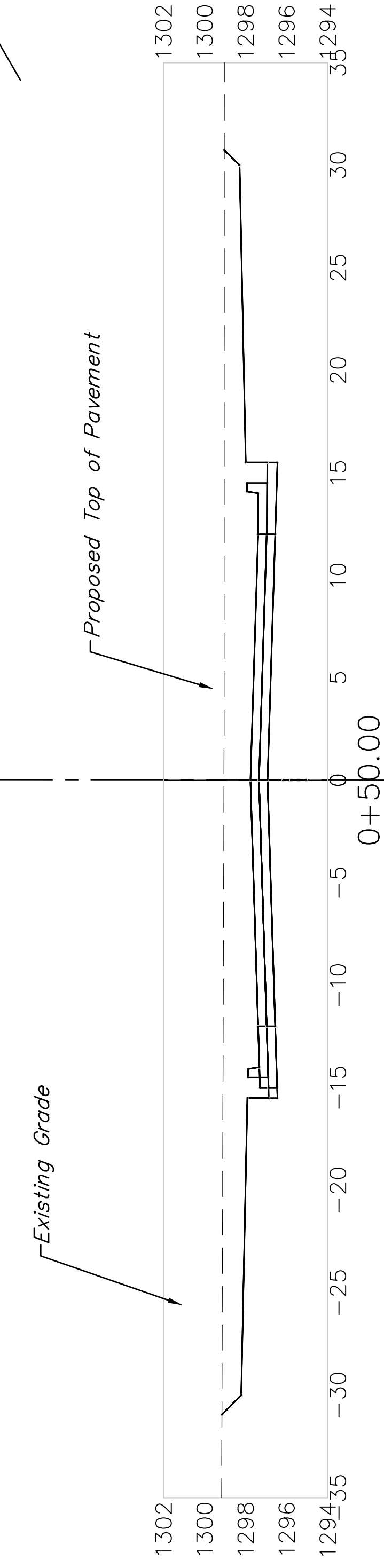

$EXC = 55.34$ C.Y.
 $LF = 0.00$ C.Y.
 $CF = 0.00$ C.Y.

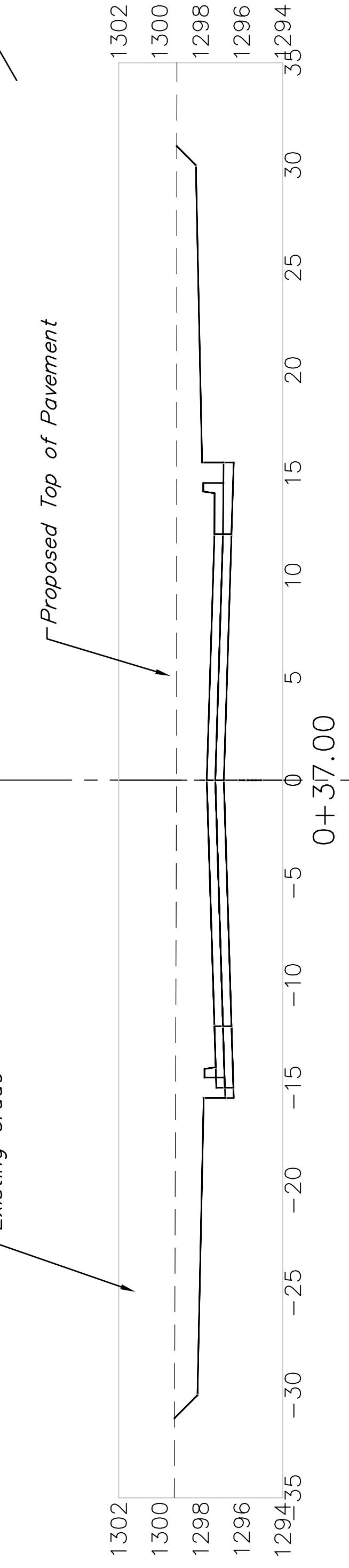

Doris Ct (Lots 1 through 8, Block C)